

Espositore estrattori a 2 zampe, modello A.F.A, con piede a punta conica sottile

Exhibitor pullers 2 conical point legs

acciaio cr. v.
zincato



codice

111 000 espositore AFA - pz. 6

art. composizione - composition

111 001 estrattore 2 zampe mm. 65 x 65

111 002 estrattore 2 zampe mm. 70 x 80

111 003 estrattore 2 zampe mm. 84 x 112

111 004 estrattore 2 zampe mm. 100 x 130

111 005 estrattore 2 zampe mm. 130 x 165

111 006 estrattore 2 zampe mm. 250 x 260

Estrattori universali a 2 zampe con piede a punta conica sottile

Universal puller 2 conical point legs

acciaio cr. v.
zincato

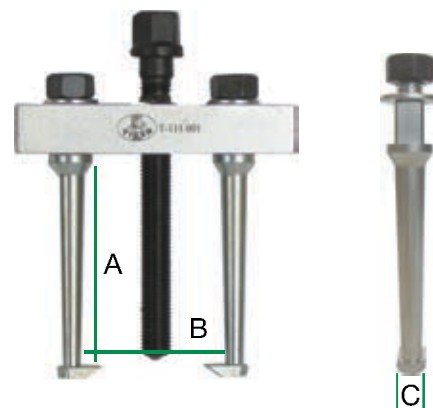

codice

111 001

A

65

B

65

C

8

vite

10x1.25xh.90

gr.

300

Ricambi per codice 111 001

Spare parts



zampa (singola con rondella e dado)

codice 111 021



traversa

codice 111 040



vite

codice 111 061

Adattatori opzionali

Optional adaptor

Prolunga per codice 111 001

Prolunga completa di zampa per codice 111 001

acciaio fosfatato

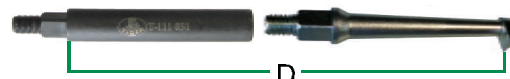
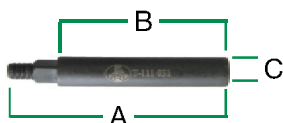

codice

111 031

A

105

B

81

C

14

filetto

8x1.25

codice

111 031 10

composizione

111 031 + 111 021

D

145

Estrattori universali a 2 zampe nervate con piede a punta sottile

Universal puller with twin ribbed point legs

acciaio cr. v.
zincato

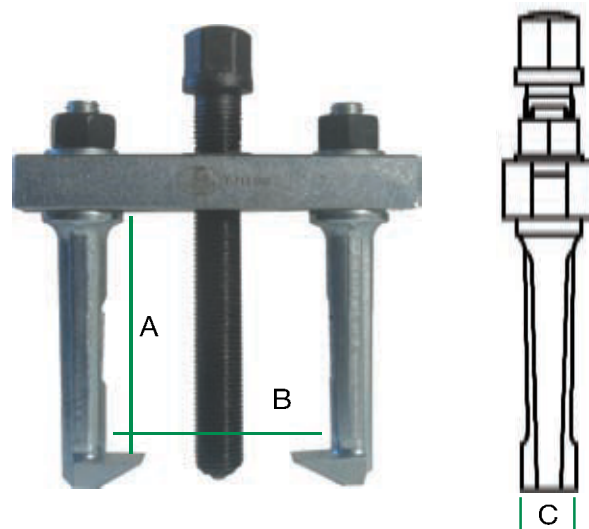

codice	A	B	C	vite	gr.
111 002	70	80	15	14 x 1.5 x h.105	600
111 003	84	112	18	16 x 1.5 x h.130	1150
111 004	100	130	21	18 x 1.5 x h.160	1700
111 005	130	165	24	20 x 1.5 x h.185	2650

Ricambi

Spare parts



per codice	zampa (singola con rondella e dado)	traversa	vite
111 002	111 022	111 042	111 062
111 003	111 023	111 043	111 063
111 004	111 024	111 044	111 064
111 005	111 025	111 045	111 065

Adattatori opzionali

Optional adaptor

Prolunga

acciaio fosfatato

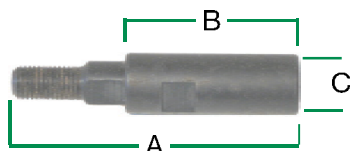

Prolunga completa di zampa

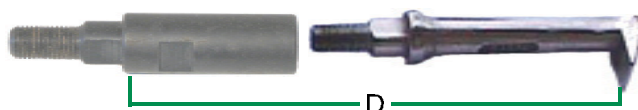

per codice	codice	A	B	C	filetto	codice	composizione	D
111 002	111 032	80	50	20	10x1.5	111 032 10	111 032 + 111 022	120
111 003	111 033 01	100	60	21	12x1.5	111 033 10	111 033 01 + 111 023	144
111 003	111 033 02	140	100	27	12x1.5	111 033 11	111 033 02 + 111 023	185
111 005	111 035 01	121	71	27	16x1.5	111 035 10	111 035 01 + 111 025	276
111 005	111 035 02	195	146	30	16x1.5	111 035 11	111 035 02 + 111 025	276

Estrattori universali a 2 zampe con piede a punta sottile

Universal puller twin point leg

acciaio speciale
forgiato

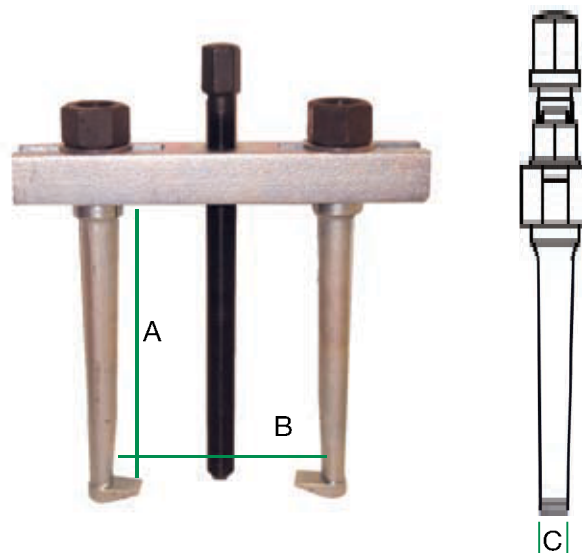

codice	A	B	C	vite	gr.
111 006	250	260	24	24x2xh.310	7800
111 007	290	300	27	27x2xh.360	9500

Ricambi

Spare parts



per codice	zampa (singola con rondella e dado)	traversa	vite
111 006	111 026	111 047	111 067
111 007	111 027	111 048	111 070

Mini estrattore universale a tre zampe a sezione tonda con piede a punta conica sottile

Universal micro puller triple with conical point leg

acciaio cr. v.
zincato

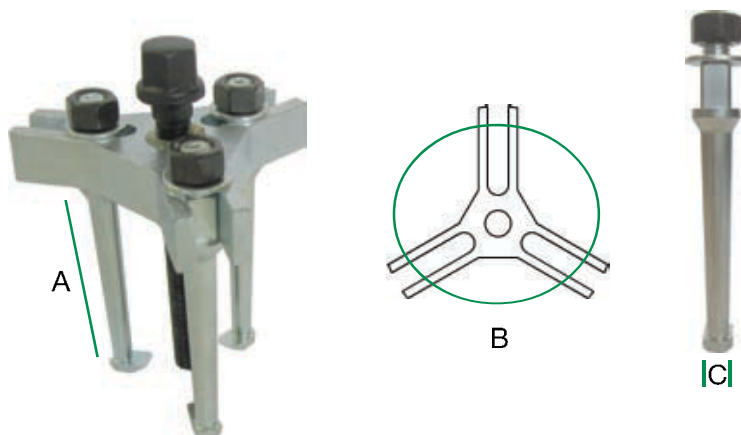

codice	A	B	C	vite	gr.
111 010	65	30-75	8	10x1.25xh.90	400

Ricambi per codice 111 010

Spare parts



zampa (singola con rondella e dado)
codice 111 021



traversa
111 051 00



vite
codice 111 061

Adattatori opzionali

Optional adaptor

Prolunga per codice 111 010

Prolunga completa di zampa per codice 111 010

acciaio fosfatato

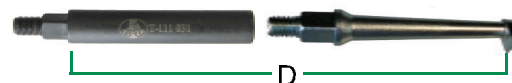
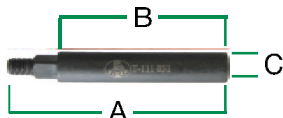

codice	A	B	C	filetto
111 031	105	81	14	8x1.25

codice	composizione	D
111 031 10	111 031 + 111 021	145

Estrattori universali a 3 zampe nervate con piede a punta sottile

Universal puller with 3 ribbed point legs

acciaio cr. v.
zincato



Caratteristica: boccia filettata in acciaio legato ad alta resistenza, grazie a questo particolare le nostre traverse. Praticamente indistruttibili.

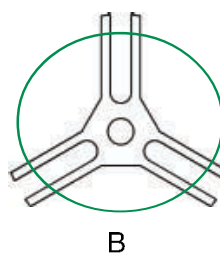
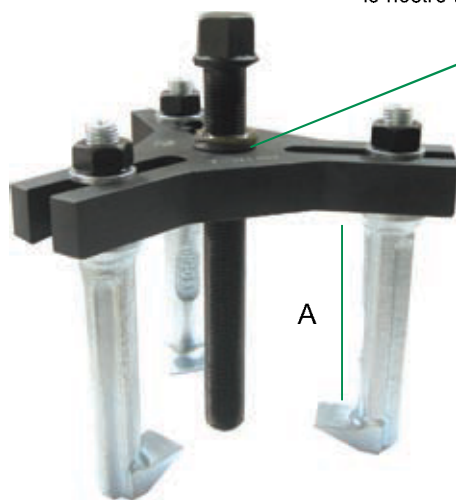

codice	A	B	C	vite	gr.
111 011	70	90	15	14x1.5xh.105	980
111 012	100	140	21	18 x 1.5 x h.160	2420
111 013	130	180	24	20 x 1.5 x h.185	4370
N.B. le seguenti misure sono con traversa zincata e senza boccole					
111 015	250	350	24	27 x 2 x h.300	12600
111 016	290	350	24	27 x 2 x h.390	14700

Ricambi

Spare parts



per codice	zampa (singola con rondella e dado)	traversa	vite
111 011	111 022	111 051	111 063
111 012	111 024	111 052	111 064
111 013	111 025	111 053	111 065
111 015	111 026	111 055	111 069
111 016	111 027	111 055	111 071

Adattatori opzionali

Optional adaptor

acciaio fosfatato



Prolunga

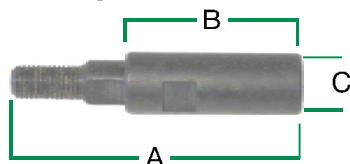

Prolunga completa di zampa

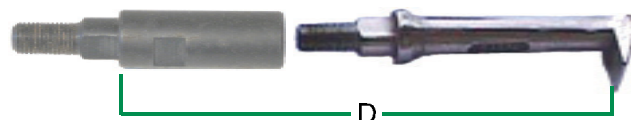

per codice	codice	A	B	C	filetto	codice	composizione	D
111 011	111 032	80	50	20	10x1.5	111 032 10	111 032 + 111 022	120
111 013	111 035 01	121	71	27	16x1.5	11103510	111 035 01 + 111 025	276
111 013	111 035 02	195	146	30	16x1.5	11103511	111 035 02 + 111 025	276

Espositore estrattori a 2 zampe, modello Starker, con piede a punta e zampa forgiata nervata

Exhibitor pullers twin with forged legs

acciaio cr. v.

STARKER



codice

111 100 espositore STARKER pz. 6

art. composizione - composition

111 001	estrattore 2 zampe mm. 65 x 65
111 102	estrattore 2 zampe mm. 70 x 75
111 103	estrattore 2 zampe mm. 95 x 130
111 104	estrattore 2 zampe mm. 125 x 165
111 105	estrattore 2 zampe mm. 150 x 200
111 106	estrattore 2 zampe mm. 180 x 240

Estrattori universali a 2 zampe forgiate / nervate con piede a punta

Universal puller with twin ribbed / forged point legs

acciaio cr. v.

STARKER

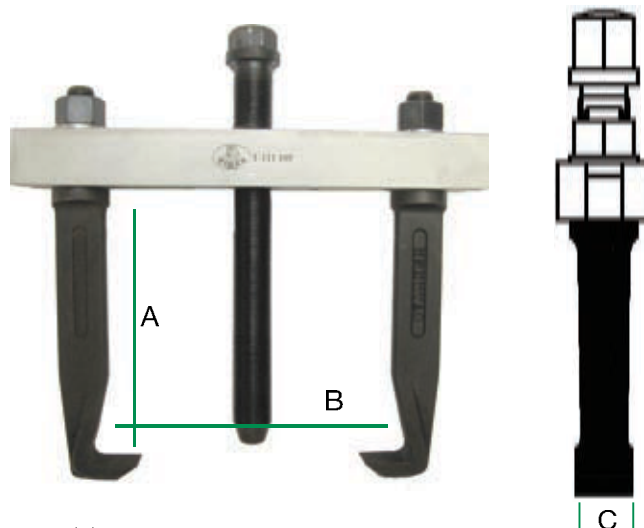
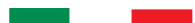

codice	A	B	C	vite	gr.
111 102	70	75	14	14 x 1.5 x h.110	700
111 103	95	130	19	18 x 1.5 x h.160	1300
111 104	125	165	24	20 x 1.5 x h.185	2000
111 105	150	200	21	22 x 1.5 x h.210	2500
111 106	180	240	27	24 x 2 x h.250	5600

Ricambi

Spare parts



per codice	zampa (singola con rondella e dado)	traversa	vite
111 102	111 122	111 042	111 062
111 103	111 123	111 044	111 063
111 104	111 124	111 045	111 064
111 105	111 12401	111 045 01	111 065 01
111 106	111 125	111 046	111 066

Adattatori opzionali

Optional adaptor

acciaio fosfatato

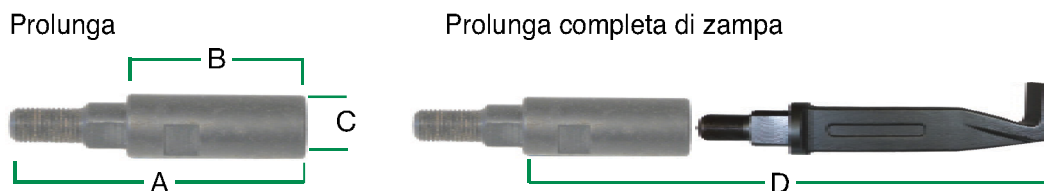

per codice	codice	A	B	C	filetto	codice	composizione	D
111 102	111 032	80	50	20	10x1.5	111 132 10	111 032 + 111 122	120
111 103	111 033 01	100	60	20	12x1.5	111 133 10	111 033 01 + 111 123	155
111 103	111 033 02	140	100	27	12x1.5	111 133 11	111 033 02 + 111 123	195
111 104	111 034 01	110	70	27	14x1.5	111 134 10	111 034 01 + 111 124	195
111 104	111 034 02	175	125	30	14x1.5	111 134 11	111 034 02 + 111 124	250
111 105	111 035 02	200	150	30	16x1.5	111 135 11	111 034 02 + 111 125	280
111 106	111 036	220	160	34	18x1.5	111 135 10	111 036 + 111 125	345

Estrattori universali con traversa chiusa a 2 zampe forgiate / nervate con piede a punta

Universal puller with closed cross with twin ribbed / forged point legs

acciaio cr. v.

STARKER

Caratteristica: traversa chiusa, grande resistenza anche sottoposta a grandi sforzi.

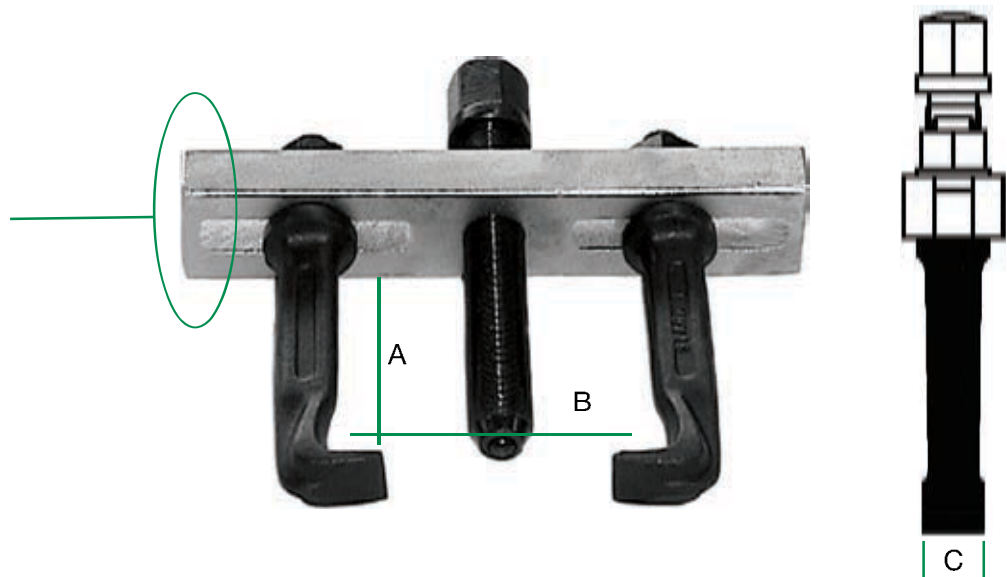

codice	A	B	C	vite	gr.
111 107	220	350	36	27 x 2 x h.270	9000
111 108	220	460	36	27 x 2 x h.300	10500
111 109	220	640	36	32 x 2 x h.340	18500

Ricambi

Spare parts



per codice	zampa (singola con rondella e dado)	traversa chiusa	vite
111 107	111 126	111 049	111 068
111 108	111 126	111 050	111 069
111 109	111 126	111 050 01	111 072

Adattatori opzionali

Optional adaptor

acciaio fosfatato



Prolunga

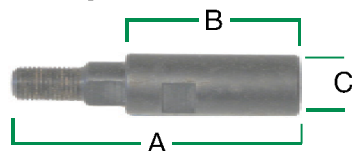

Prolunga completa di zampa

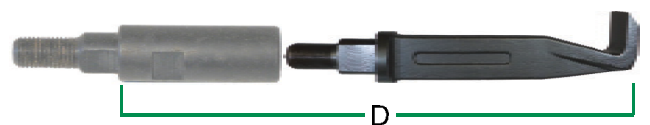

per codice	codice	A	B	C	filetto
111 107	111 037	290	220	35	18x1.5
111 108	111 037	290	220	35	18x1.5
111 109	111 037	290	220	35	18x1.5

codice	composizione	D
111 136 10	111 037 + 111 126	440

Estrattori universali a 3 zampe forgiate / nervate con piede a punta

Universal puller with 3 ribbed / forged point legs

acciaio cr. v.

STARKER

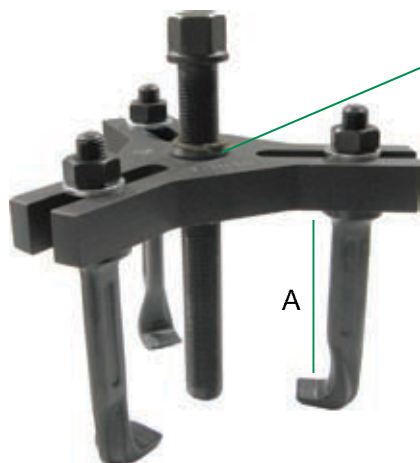

Caratteristica: boccia filettata in acciaio legato ad alta resistenza, grazie a questo particolare le nostre traverse. Praticamente indistruttibili

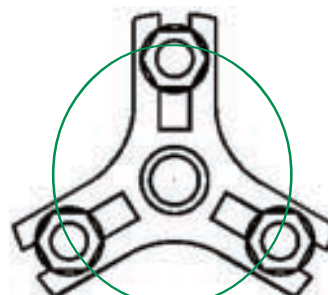

codice	A	B	C	vite	gr.
111 111	70	90	15	16 x 1.5 x h.100	800
111 112	95	140	19	18 x 1.5 x h.160	700
111 113	125	180	24	20 x 1.5 x h.185	1200
111 11310	150	210	21	22 x 1.5 x h.210	2500
111 114	180	250	27	27 x 2 x h.270	9000
111 115	220	350	36	27 x 2 x h.270	13000
111 116	220	520	36	32 x 2 x h. 300	14700

Ricambi

Spare parts



per codice	zampa (singola con rondella e dado)	traversa chiusa	vite
111 111	111 122	111 051	111 063
111 112	111 123	111 052	111 064
111 113	111 124	111 053	111 065
111 113 10	111 124 01	111 053 01	111 065 01
111 114	111 125	111 054	111 068
111 115	111 126	111 055	111 068
111 116	111 126	111 056	111 072

Adattatori opzionali

Optional adaptor

acciaio fosfatato



Prolunga

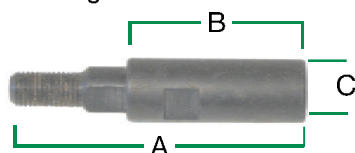

Prolunga completa di zampa

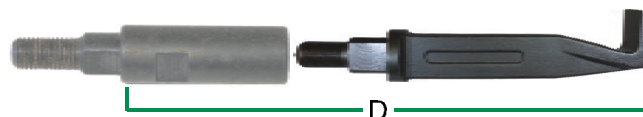

per codice	codice	A	B	C	filetto	codice	composizione	D
111 111	111 032	80	50	20	10x1.5	111 132 10	111 032 + 111 122	120
111 112	111 033 01	100	60	21	12x1.5	111 133 10	111 033 01 + 111 123	155
111 112	111 033 02	140	101	27	12x1.5	111 133 11	111 033 02 + 111 123	195
111 113	111 034 01	111	71	27	14x1.5	111 134 10	111 034 01 + 111 124	195
111 113	111 034 02	175	125	30	14x1.5	111 134 11	111 034 02 + 111 124	250
111 114	111 036	220	160	34	18 x 1.5	111 135 10	111 036 + 111 125	345
111 115 & 116	111 037	290	220	35	18 x 1.5	111 136 10	111 037 + 111 126	440

Estrattori universali a 2 zampe a punta in acciaio forgiato

Universal puller with twin point legs drop forged steel

Made in Italy

codice	A	B
111 201	75	60
111 202	75	80
111 203	75	100
111 204	100	120
111 205	100	140
111 206	100	160
111 207	140	180
111 208	140	200
111 209	250	250
111 210	300	300

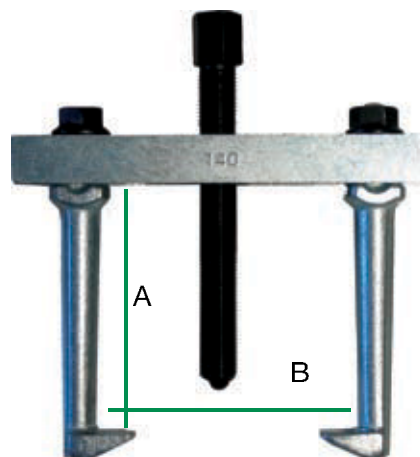

Ricambi

Spare parts



per codice	zampa	traversa	vite
111 201	111 221	111 241	111 261
111 202	111 222	111 242	111 262
111 203	111 222	111 243	111 263
111 204	111 223	111 244	111 264
111 205	111 223	111 245	111 265
111 206	111 223	111 246	111 266
111 207	111 224	111 247	111 267
111 208	111 224	111 248	111 268
111 209	111 225	111 249	111 269
111 210	111 226	111 250	111 270

NOTE



Estrattori universali a 3 zampe a punta in acciaio forgiato

Universal puller 3 point legs drop forged steel

Made in Italy

codice	A	B
111 211	75	90
111 212	100	120
111 213	100	160
111 214	140	180
111 215	250	250
111 216	250	350
111 217	300	350

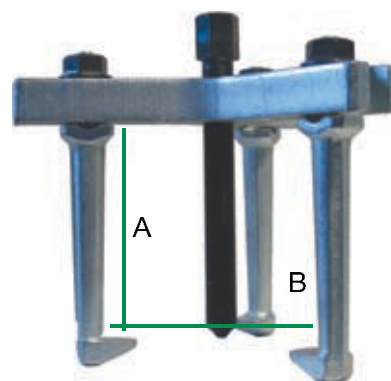

Ricambi

Spare parts



per codice	zampa	traversa	vite
111 211	111 222	111 251	111 271
111 212	111 223	111 252	111 272
111 213	111 223	111 253	111 273
111 214	111 224	111 254	111 274
111 215	111 225	111 255	111 275
111 216	111 225	111 256	111 276
111 217	111 226	111 257	111 277

Estrattori universali a 2 zampe a punta in acciaio forgiato

Universal puller 2 point legs drop forged steel

Made in Italy

codice	A	B
111 301	98	80
111 302	98	130
111 303	150	160
111 304	150	200
111 305	200	250
111 306	200	350
111 307	200	520

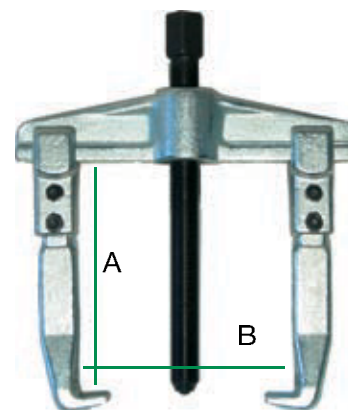

Ricambi

Spare parts

Adattatori opzionali

Optional adaptor



per codice	zampa	traversa	vite	Zampa prolungata	C
111 301 / 111 302	111 321	111 341 - 111 342	111 351 - 111 352	111 331	200
111 303 / 111 304	111 322	111 343 - 111 344	111 353 - 111 354	111 332	300
111 305 / 111 306 / 111 307	111 323	111 345 - 111 346 - 111 347	111 355 - 111 356 - 111 357	111 333	350
111 305 / 111 306 / 111 307	111 323	111 345 - 111 346 - 111 347	111 355 - 111 356 - 111 357	111 334	520

Estrattore universale a 2 zampe oscillanti e punta a spillo - Vite testa stampata con filetto rollato

Universal puller 2 point swinging legs

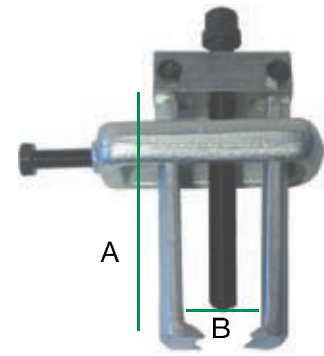

codice	A	B
111 480 01	Min 13 / Max 140	10

Ricambi

Spare parts



Traversa	Zampa	Vite 16 x 1,5 x 165	Anello completo	Vite extra lunga 16 x 1,5 x 250
111 48201	111 483 01	111 484 01	111 485 01	111 486

Estrattore universale a 2 zampe con fermo a vite - Zampe forgiate con occhiello per traversa

Universal puller 2 legs

acciaio speciale
cromato

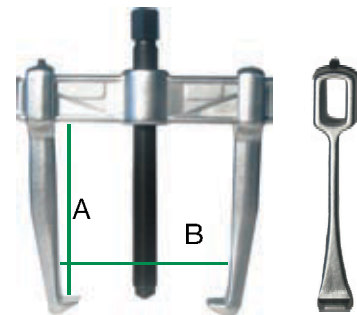

codice	A	B
112 001	100	15 - 85
112 002	100	15 - 125
112 003	150	20 - 160
112 004	150	20 - 200

Set estrattore a 2 zampe, con 3 coppie di zampe di diverse misure: 1 vite standard di mm 140 e 1 vite lunga mm 250

2 legs extractor set. Included 3 pair of legs

acciaio cr. v
cromato brunito

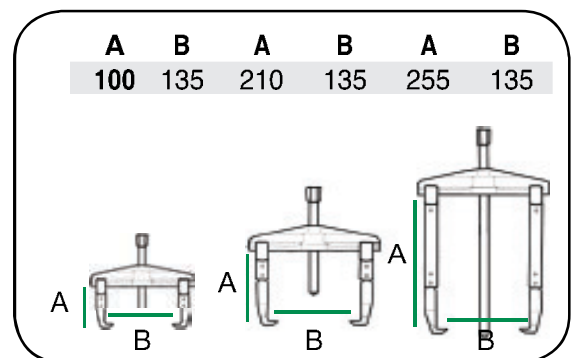
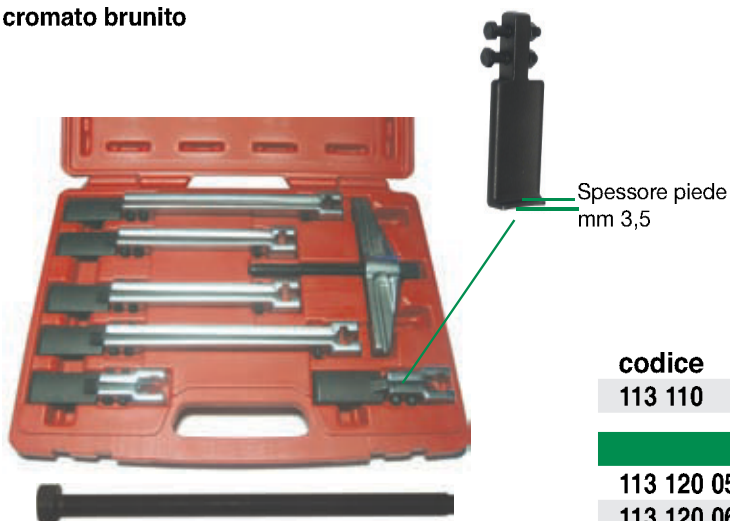

codice	quantità
113 110	Pz 8 in valigetta

Ricambi - Spare parts

113 120 05	vite lunga: ø 14 x 250
113 120 06	coppia di ganasce corte per attacco zampe
113 120 07	coppia di ganasce medie per attacco zampe
113 120 08	coppia di ganasce lunghe per attacco zampe
113 120 10	zampa di ricambio con piede spessore mm 3,5

Set estrattore a 2 & 3 zampe, con tre coppie di zampe di diverse misure: vite standard di mm 140 e una vite lunga mm 250

3 legs extractor set. Included 3 pair of legs

acciaio cr. v
cromato brunito

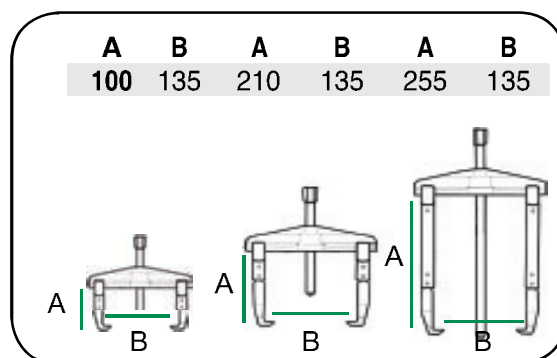
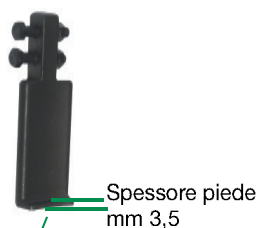

codice	quantità
113 120	Pz 13 in valigetta

Ricambi - Spare parts	
113 120 05	Vite lunga: Ø 14 x 250
113 120 06	Coppia di ganasce corte per attacco zampe
113 120 07	Coppia di ganasce medie per attacco zampe
113 120 08	Coppia di ganasce lunghe per attacco zampe
113 120 10	Zampa di ricambio con piede spessore mm 3,5

Adattatori opzionali per Codici 113 110 & 113 120

Optional adaptor

acciaio cr. v
cromato brunito

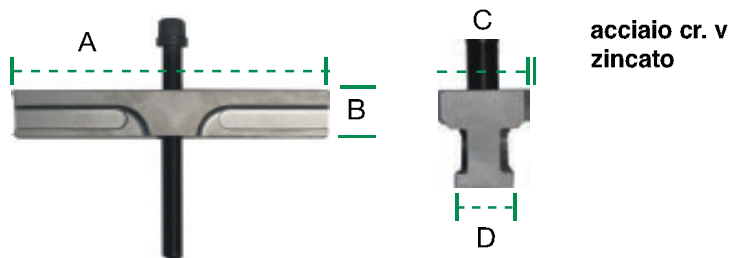
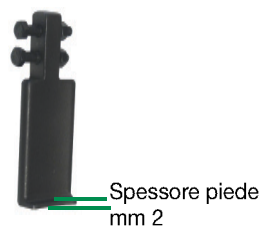

acciaio cr. v
zincato

Zampa con piede spessore mm 2	
113 120 09	

Traversa con fresatura per attacco zampe estrattori				
113 130	A	B	C	D
	235	35	30	20

Estrattore a 3 zampe autoserrante

3 Legs extractor.

acciaio cr. v
zincato

Esterni

Interni

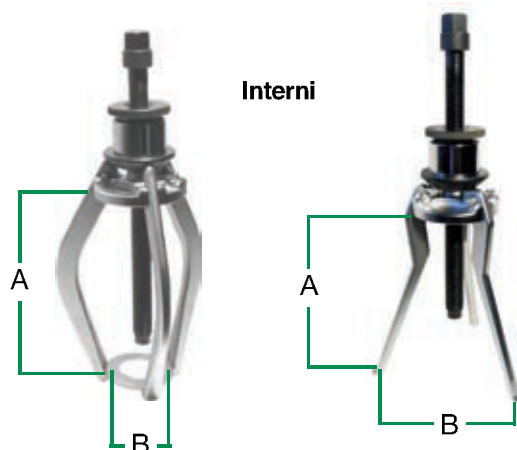

codice		A	B
116 001	esterni	147	Min 7 - Max 140
116 002	esterni	200	Min 10 - Max 180
116 003	esterni	250	Min 20 - Max 260
116 006	interni	140	Min 23 - Max 130
116 007	interni	190	Min 50 - Max 170

Ricambi

Spare parts

per codice			
116 001	esterni	116 010	
116 002	esterni	116 011	
116 003	esterni	116 012	
116 006	interni	116 020	
116 007	interni	116 021	

Esterni



Interni



Estrattore a 2 zampe autoserrante

2 Legs exctrator.

acciaio cr. v
zincato

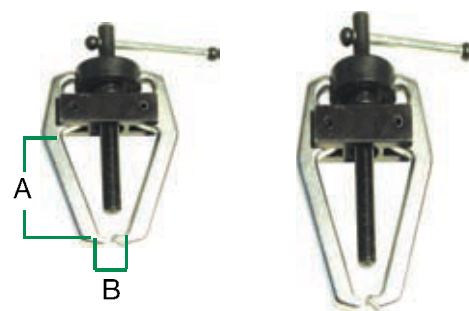

codice	A	B	
117 001	40	0 - 35	per tergicristalli
117 002	60	0 - 45	per morsetti batteria

Estrattore universale ideale per tergicristalli

Universal wiper arm puller

codice	A	B
117 005	40	0 - 35

Dati tecnici - Informative

- di facile impiego, compatto e leggero
- evita le rotture del tergicristallo



Estrattore a 3 zampe sottili, autoserrante, indicato per lavori leggeri

Self - gripping 3 leg puller

acciaio cr. v
cromato

codice	A	B
118 001	80	17 - 80
118 002	150	25 - 150
118 003	200	25 - 200

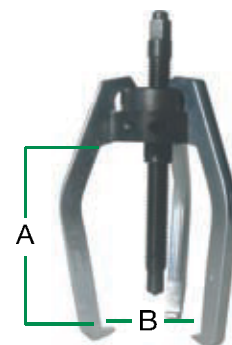

Estrattori universali a 2 zampe autoserranti in Acciaio forgiato

Universal pullers 2 automatic shut legs on drop forged steel

codice	A	B
121 001	40	55
121 002	65	65
121 003	80	80
121 004	120	120
121 005	160	160
121 006	225	225
121 007	300	300
121 008	425	425

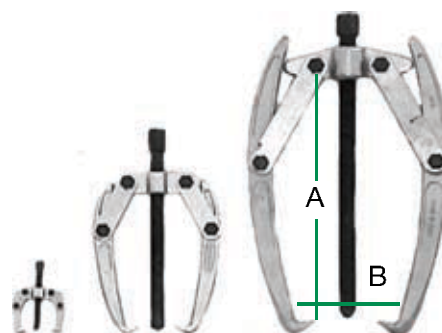

Ricambi

Spare parts

Per codici	Zampa	Traversa	Vite
121 001	121 021	121 031	121 051
121 002	121 022	121 032	121 052
121 003	121 023	121 033	121 053
121 004	121 024	121 034	121 054
121 005	121 025	121 035	121 055
121 006	121 026	121 036	121 056
121 007	121 027	121 037	121 057
121 008	121 028	121 038	121 058

zampa



traversa



vite



Estrattori universali a 3 zampe autoserranti in Acciaio forgiato

Universal pullers 3 automatic shut legs on drop forged steel

codice	A	B
121 011	40	55
121 012	65	65
121 013	80	80
121 014	120	120
121 015	160	160
121 016	225	225
121 017	300	300
121 018	425	425

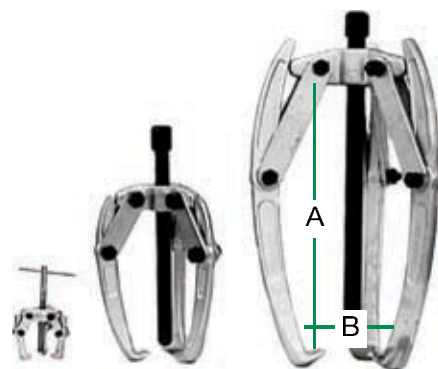

Ricambi

Spare parts

Per codici	Zampa	Traversa	Vite
121 011	121 021	121 041	121 061
121 012	121 021	121 042	121 062
121 013	121 023	121 043	121 063
121 014	121 024	121 044	121 064
121 015	121 025	121 045	121 065
121 016	121 026	121 046	121 066
121 017	121 027	121 047	121 067
121 018	121 028	121 048	121 068

zampa



traversa



vite



Estrattori universali a 2 e 3 zampe reversibili in Acciaio legato

Universal pullers 2 automatic shut legs at double thickness on drop forged steel

acciaio cr. v
cromato

Codice		A	B
121 101	2 zampe	80	150
121 102	2 zampe	130	200
121 111	3 zampe	80	150
121 112	3 zampe	130	200

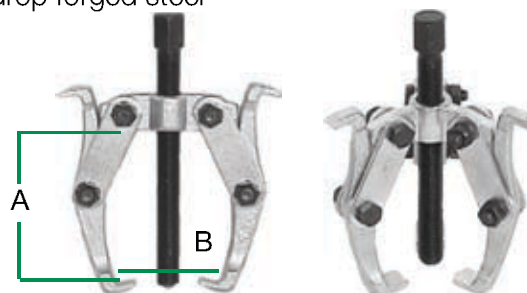

Ricambi

Spare parts

Per codici	Zampa	Traversa	Vite
121 101 e 121 111	121 121	121 131 - 121 141	121 151 - 121 161
121 102 e 121 112	121 122	121 132 - 121 142	121 152 - 121 162

zampa



traversa



vite



Set estrattore a 2 zampe, con 3 coppie di zampe di diverse misure: 1 vite standard di mm 140 e 1 vite lunga mm 250

2 legs extractor set. Included 3 pair of legs

acciaio forgiato

Codice	A	B
121 191	180	325
Ricambi		Spare parts
Zampa	Traversa con vite	Vite
121 192	121 193	121 194

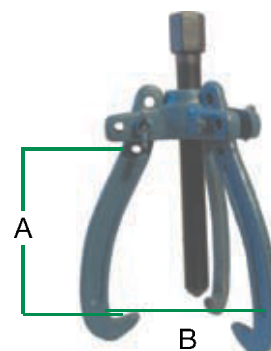

Estrattori universali a 2 zampe autoserranti a doppia sagoma

Universal pullers 2 automatic shut legs double outline on drop

acciaio forgiato

codice	A	B
121 201	170	95
121 202	270	135
121 203	325	250

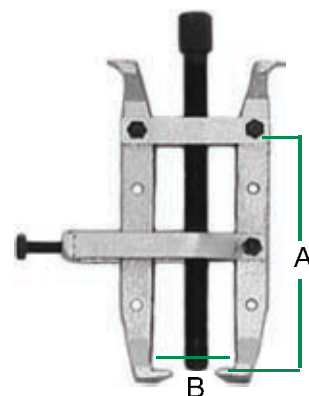

Ricambi

Spare parts

Per codici	Zampa	Traversa	Vite
121 201	121 221	121 231	121 251
121 202	121 222	121 232	121 252
121 203	121 223	121 233	121 253

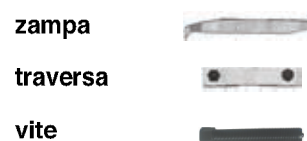

Estrattore universale a due zampe autoserranti

Universal puller twin automatic shut legs

acciaio speciale cromato

Codice	A	B	Torsione max (Nm)
121 361	70 - 85	6 - 100	45
121 362	85 - 120	10 - 140	65

Spine ad innesto rapido per un veloce cambio di misura

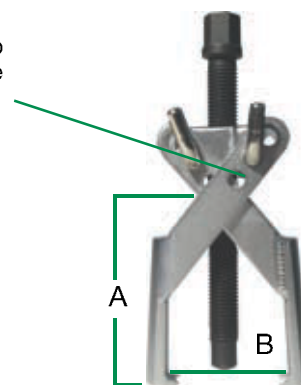

Estrattori universali a 2 zampe

Universal puller 2 legs drop forged steel

acciaio forgiato

codice	A	B
121 401	100	100
121 402	150	150
121 403	220	220
121 404	270	300
121 405	400	350

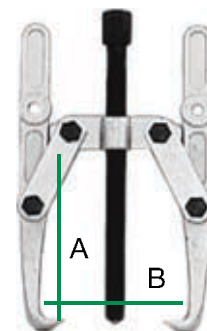

Ricambi

Spare parts

Per codici	Zampa	Traversa	Vite
121 401	121 421	121 431	121 451
121 402	121 422	121 432	121 452
121 403	121 423	121 433	121 453
121 404	121 424	121 434	121 454
121 405	121 425	121 435	121 455



Estrattori universali a 3 zampe

Universal puller 3 legs drop forged steel

acciaio forgiato

codice	A	B
121 411	100	100
121 412	150	150
121 413	220	220
121 414	270	300
121 415	400	350

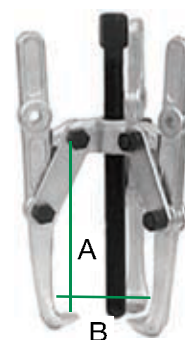

Ricambi Spare parts

Per codici	Zampa	Traversa	Vite
121 411	121 421	121 441	121 461
121 412	121 422	121 442	121 462
121 413	121 423	121 443	121 463
121 414	121 424	121 444	121 464
121 415	121 425	121 445	121 465



Estrattori universali a 3 zampe

Universal puller 3 legs drop forged steel

acciaio forgiato

codice	A	B
131 001	50	60
131 002	60	80
131 003	90	120
131 004	110	160
131 005	110	190

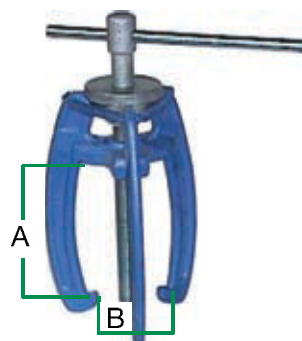

Ricambi Spare parts

Per codici	Zampa	Traversa con cono	Vite
131 001	131 021	131 031	131 051
131 002	131 022	131 032	131 052
131 003	131 023	131 033	131 053
131 004	131 024	131 034	131 054
131 005	131 024	131 035	131 055



Estrattori universali a 3 zampe

Universal puller 3 legs drop forged steel

acciaio forgiato

codice	A	B
131 101	150	250
131 102	190	300
131 103	200	350
131 104	230	425
131 105	250	500
131 106	400	700

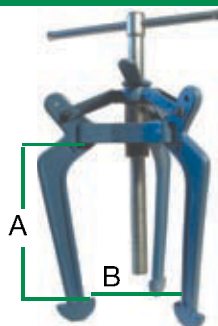

Ricambi Spare parts

Per codici	Zampa	Traversa completa	Vite
131 101	131 121	131 131	131 151
131 102	131 122	131 132	131 152
131 103	131 123	131 133	131 153
131 104	131 124	131 134	131 154
131 105	131 125	131 135	131 155
131 106	131 126	131 136	131 156



Estrattore a cavalletto per viti

Screw plugs



Codice

135 000 in valigetta M - 4 - 5 - 6 - 8 - 10 - 12

Cassetta pinze ad espansione per estrazioni interne dei cuscinetti

Ball bearing puller set with internal extractor and counter stay devices

codice

141 003 in valigetta pz 9



Composizione - Composition

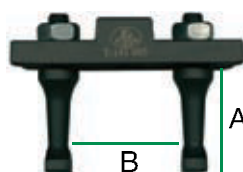

Estrattore

141 005	A	B
	42	90



Pinze	Ø	Pinze	Ø
141 010	mm 10	141 020	mm 20
141 012	mm 12	141 025	mm 25
141 015	mm 15	141 027	mm 27
141 017	mm 17	141 030	mm 30

Adattatore opzionale

Optional adaptor

Estrattore a percussione con boccia filetto femmina per pinze cuscinetti interni

codice

141 006



mm 380

141 006 10 Boccia con attacco femmina 10 x 1,5



141 006 18 Boccia con attacco maschio 18 x 1,5



141 006 22 Boccia con attacco maschio 22 x 1,5



Kit pinze ad espansione con estrattore a percussione

Ball bearing puller with percussion extractor

codice

141 004 in valigetta pz 10



Composizione - Composition

codice

141 006



mm 380

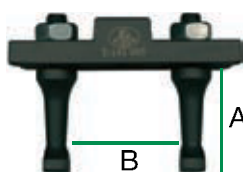

Estrattore

141 005	A	B
	42	90



Pinze	Ø	Pinze	Ø
141 010	mm 10	141 020	mm 20
141 012	mm 12	141 025	mm 25
141 015	mm 15	141 027	mm 27
141 017	mm 17	141 030	mm 30

Kit pinze ad espansione per cuscinetti con due estrattori a percussione 8 x 1.25 e 10 x 1.25

Ball bearing puller with percussive puller 8 x 1.25 - 10 x 1.25



codice
141 101 01 in valigetta pz 11



Composizione - Composition



L mm

Estrattore	L	Pinza	Ø
141 102	(8 x 1.25) 395	141 110	(8 x 1.25) mm 10
		141 112	(8 x 1.25) mm 12
		141 115	(8 x 1.25) mm 15
		141 117	(8 x 1.25) mm 17
		141 120	(8 x 1.25) mm 20
141 103	(10 x 1.25) 420	141 125	(10 x 1.25) mm 25
		141 127	(10 x 1.25) mm 27
		141 130	(10 x 1.25) mm 30

Kit pinze ad espansione per cuscinetti con estrattore a percussione

Ball bearing puller with percussive puller



codice
141 105 pz 4



Composizione - Composition



L mm

Estrattore	L	Pinza	Ø
141 102	(8 x 1.25) 395	141 110	(8 x 1.25) mm 10
		141 112	(8 x 1.25) mm 12
		141 115	(8 x 1.25) mm 15

Set battitoi per introduzione dei cuscinetti a percussione oppure con pressa

Set for bearings percussive tipe

Codice
141 140 in valigetta dischi in alluminio pz 10

Ø Interno
35,5 - 39 - 44 - 53 - 58 - 60 - 67 - 71 - 76,5



Set introduzione guarnizioni CORTECO

O-ring remover & installer kit

Codice
141 141 in valigetta



Cassetta pinze ad espansione con estrattore separatore per cuscinetti, completo di prolunghe

Ball bearing puller set with puller and separator



codice

141 200 in valigetta pz 17

Per cuscinetti interni / esterni

Ricambi - Spare parts



Estrattore
141 250



Prolunga
141 253



Prolunga
141 254



Estrattore
141 257



Pinze	Ø	Pinze	Ø
141 212	mm 12	141 225	mm 25
141 215	mm 15	141 227	mm 27
141 217	mm 17	141 230	mm 30
141 220	mm 20	141 233	mm 33
141 223	mm 23	141 235	mm 35

Cassetta pinze ad espansione con estrattore a vite

Ball bearing puller set with screw puller



codice

141 205 in valigetta pz 11

Per cuscinetti interni

Ricambi - Spare parts



Estrattore
141 250

Pinze	Ø	Pinze	Ø
141 212	mm 12	141 225	mm 25
141 215	mm 15	141 227	mm 27
141 217	mm 17	141 230	mm 30
141 220	mm 20	141 233	mm 33
141 223	mm 23	141 235	mm 35

Valigetta in plastica per pinze ad espansione con estrattore a percussione

Ball bearing puller set with percussion



codice

141 206 in valigetta pz 11

Ricambi - Spare parts



Estrattore a colpo
141 240

Pinze	Ø	Pinze	Ø
141 212	mm 12	141 225	mm 25
141 215	mm 15	141 227	mm 27
141 217	mm 17	141 230	mm 30
141 220	mm 20	141 233	mm 33
141 223	mm 23	141 235	mm 35

Estrattore a percussione per cuscinetti utilizzabile con nostre pinze da 141 212 a 141 235

Percussion extractor for bearing

codice

141 240



Attrezzo utilizzabile con le pinze ad espansione da 141 212 a 141 235

Extractor for bearing



codice

141 250 Atrezzo completo escluso di prolunghe



Ricambi - Spare parts

Adattatori opzionali - Optional

					
Traversa	Corpo	Tirante c. piede	Piede	Prolunga	Prolunga
141 251	141 252	141 255	141 257	141 253 mm40	141 254 mm 80

Estrattore a 3 zampe rovesciabili per cuscinetti

Extractor to 3 overturnable legs for pad

codice

141 258

Ricambi - Spare parts



Zampa

141 258 01



Interno
mm 19 - 45



Esterno
Max mm 72

Kit pinze ad espansione per estrazione cuscinetti

Ball bearing puller set with percussion puller

codice

141 260

Misure

7-10 / 10-14 / 14-20 / 20-30 / 30-40 in valigetta pz 8

Composizione - Composition



6 Pinze

Da 141 261 - a 141 265



Cavallotto

141 266



Estrattore a percussione

141 267



Pinze ad espansione

Ball bearing puller

Pinze per codice 141 266 & codice 141 267

141 261 Ø 7 - 10

141 262 Ø 10 - 14

141 263 Ø 14 - 20

141 264 Ø 20 - 30

141 265 Ø 30 - 40

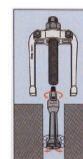

Pinze per codice 141 266 01

141 265 01 40 - 50

141 265 02 50 - 60

141 265 02 50 - 60



Estrattori a cavallotto per pinze da 141 261 a 141 265 03

Counter stay device

Codice

Per pinze

141 266 141 261 - 141 262 - 141 263 - 141 264 - 141 265

141 266 01 141 265 01 - 141 265 02 - 141 265 03

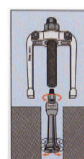

141 266 01



141 266

Vite con foro interno filettato per pinze da 141 261 a 141 265

Vite con foro interno filettato per pinze da 141 265 01 a 141 265 03



Estrattore a percussione per cuscinetti utilizzabile con nostre pinze da 141 261 a 141 265

Percussion extractor for bearing

codice
141 267

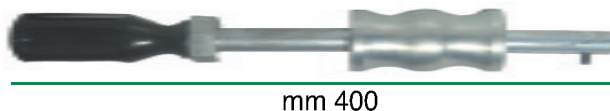

mm 400

Kit pinze ad espansione per estrazione cuscinetti

Ball bearing puller set

codice

Misure

141 268 7-10 / 10-14 / 14-20 / 20-30 / 30-40 / 40-50 / 50-60 / 60-70 in valigetta pz 10

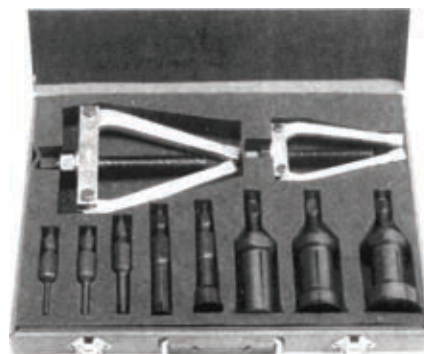

Ricambi - Spare parts



8 Pinze

Da 141 261 - a 141 265 03



Estrattore a cavalletto

141 266



Estrattore a cavalletto

141 266 01

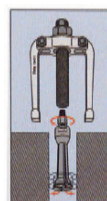

Estrattore con 3 prolunghe e separatore per cuscinetti ed ingranaggi

Bearing puller with prolong and separator for ball bearing and gears



Codice	A	B	C	D
141 271	70	Ø 20 - 95	80	60

Caratteristica: la particolare fresatura, effettuata con macchine CNC, consente un graduale inserimento delle ganasce. Conseguentemente viene agevolata l'estrazione grazie alla distribuzione sui 360° e su tutti i punti da Ø20 a Ø95, della forza di reazione espressa dalla vite.

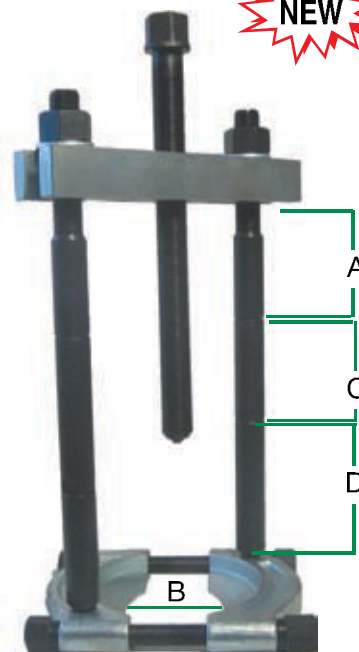
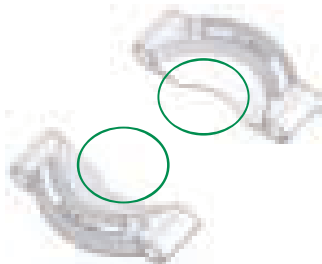

Ricambi - Spare parts



Traversa	Vite centrale 18x1,5x210	Prolunga 12x1,25 - mm 60	Prolunga 12x1,25 - mm 80	Prolunga + attacco per traversa 12x1,25 - mm 70	Tirante singolo per separatore 12x1,5 - mm 180	Separatore con tiranti
141 044	111 064	141 253	141 254	141 255	141 275	141 273

Estrattore con flangia per cuscinetti ed ingranaggi TRUCK

Bearing puller with prolong for TRUCK



Codice	A	B
141 281	240	50 - 200

Ricambi - Spare parts



Separatore con tiranti	Tirante singolo per separatore	Traversa	Vite con fondello	Tirante laterale mm 240
141 282	141 283	111 285	141 286	141 287

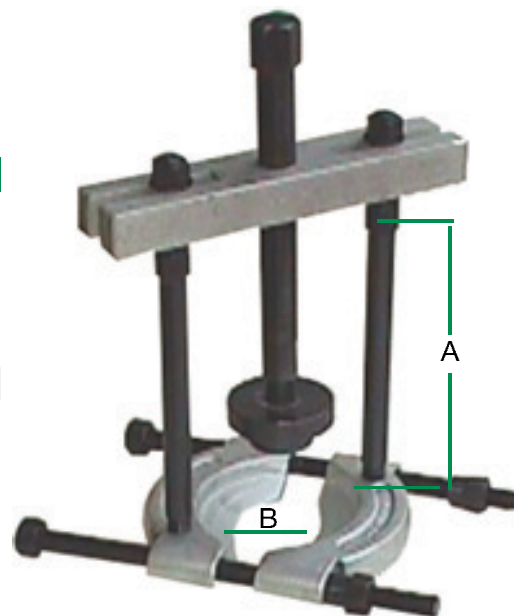

Adattatori opzionali - Optional



Prolunga mm 200
141 288

Estrattore combinato con vite idraulica da 8 Ton

Ball bearing puller with percussion extractor

codice

141 300 in valigetta

Composizione - Composition

- Pz 1 Separatore Ø 20 - 105
- Pz 3 Zampe mm 100
- Pz 3 Zampe mm 150
- Pz 3 Zampe mm 200
- Pz 2 Bulloni mm 180
- Pz 2 Prolunghe mm 230
- Pz 1 Traversa mm 180
- Pz 1 Vite idraulica ton. 8
- Pz 1 Staffa 2 teste per zampe con ghiera
- Pz 1 Staffa 3 teste per zampe con ghiera



Estrattore con tiranti a vite utilizzabili con separatori ingranaggi cuscinetti

For remover bearing with expansion puller

Codice estrattore	A	utilizzabili con separatori	Ø tiranti C
141 330	50 - 120	141 340	Ø10 x 1.5
141 331	65 - 185	141 341	Ø16 x 2
141 331 01	120 - 300	141 342	Ø20 x 2.5

Codice separatori	B	utilizzabili con separatori	Ø tiranti C
141 340	10 - 060	141 330	M10 x 1.5
141 341	20 - 110	141 331	M16 x 2
141 342	30 - 150	141 331 01	M20 x 2.5

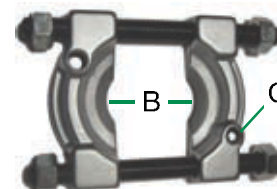
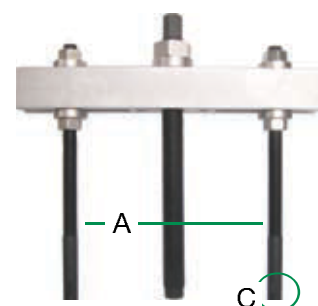

Estrattore con piedi da appoggio e tiranti a vite, utilizzabili con separatori ingranaggi cuscinetti

For remover bearing with expansion puller

Codice estrattore	A	utilizzabili con separatori	Ø tiranti C
141 332	170 - 400	141 343	Ø22 x 2.5
		141 344	

Codice separatori	B	utilizzabili con separatori	Ø tiranti C
141 343	20 - 180	141 332	M22 x 2,5
141 344	25 - 250	141 332	M22 x 2,5

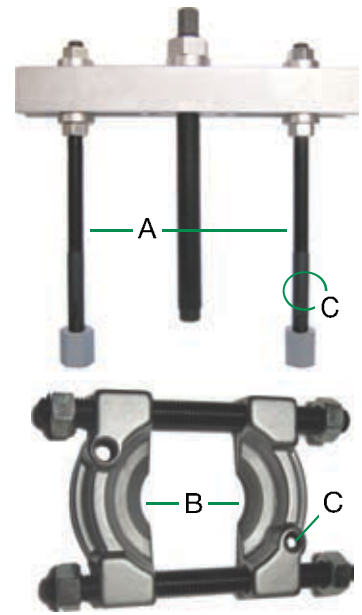

Estrattore con prolunghe e flangia per cuscinetti ed ingranaggi

Bearing puller with prolong

Codice estrattore	A	B
141 361	150	20 - 60
141 362	150	25 - 75
141 363	150	40 - 115

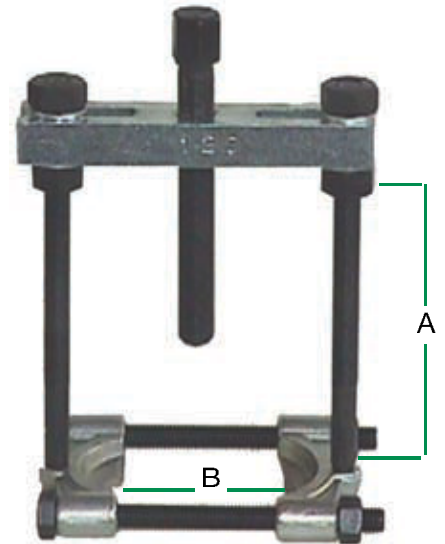

Ricambi - Spare parts



Per codice	Separatore	Tirante x sep.	Traversa	Vite	Tirante lat.
141 361	141 366	141 372	141 380	141 390	141 393
141 362	141 367	141 372	141 380	141 390	141 393
141 363	141 368	141 373	141 381	141 391	141 394



Estrattore in valigetta con prolunghe e flangia per cuscinetti e ingranaggi - Vite di pressione per serraggio veloce

Bearing puller set with prolungr

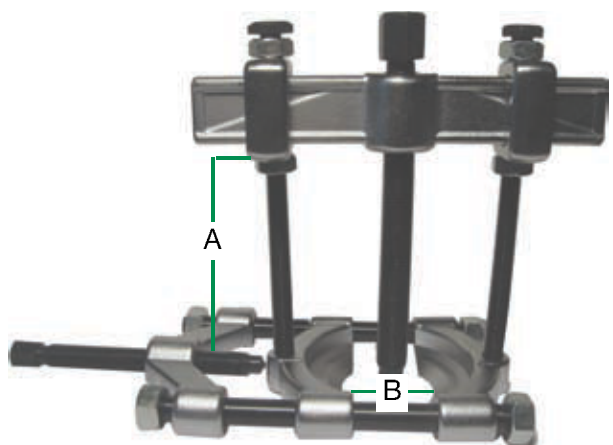

Codice	A	A con prolunghe	B
141 403	100	200	12 - 75 in valigetta



Cassetta estrazione cuscinetti a sfera

Kit extraction ball bearing

codice

141 450 in valigetta Pz 44

Composizione - Composition

	Griffe	Corpi con vite e Asta
Pz 4	mm 4x140	Pz 1 Ø 25
Pz 4	mm 5x145	Pz 1 Ø 35
Pz 8	mm 6x177	Pz 1 Ø 40
Pz 4	mm 7x185	Pz 1 Ø 50
Pz 4	mm 8x177	Pz 1 Ø 65
Pz 4	mm 9x235	
Pz 4	mm 10x235	



Set estrattori cuscinetti con inserimento zampa nella pista sfere previa rottura della gabbia cuscinetto

Micro - Engineering puller kit

codice

Misure

141 460 Per cuscinetti da Ø 25 a 90 - Zampa Ø 5 - 6 - 8 in valigetta pz 10

Ricambi - Spare parts

- 141 46055 Coppia zampe Ø 5
- 141 46060 Coppia zampe Ø 6
- 141 46080 Coppia zampe Ø 8



Flangia per pressa per cuscinetti e ingranaggi

Separator for ball bearing and gears

Codice	A	B	C	D
141 500	40	28	40	70

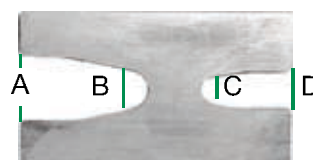

Estrattore a zampe lunghe con capacità da Ø 10 a Ø 50

Extractor long with with ability from Ø10 to Ø50

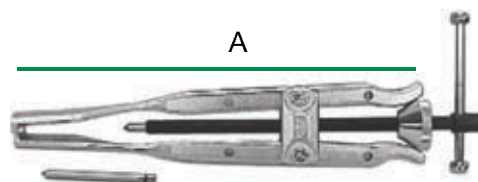

Codice	A
142 000	300

Estrattore perni sferici per tiranti sterzo auto

Ball joint puller of tierods



codice	A	B	C
151 001	45	42	19

Ricambi - Spare parts



Vite
151 002

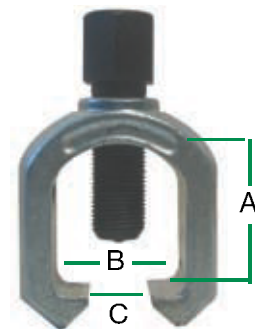

Estrattore perni a sfera

Extractor spherical pivots



codice	A	B	C
151 010	70	70	32
151 012	70	78	38

Ricambi - Spare parts

Per codice	Vite
151 010 & 151 012	151 011

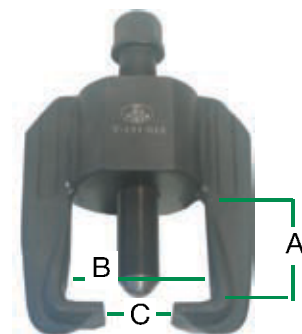

Estrattore perni sferici tiranti sterzo auto

Ball joint puller of tierods



codice	A	B	C
151 020	39	15	39
151 021	39	18	39
151 024	64	23	40

Ricambi - Spare parts

Per codice	Vite
151 020 & 151 021	151 022
151 024	151 025

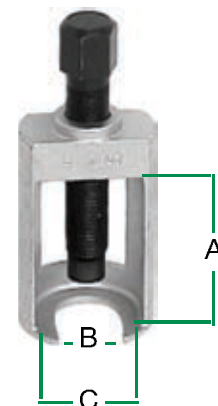

NOTE



Set 3 estrattori per snodi sferici

Ball joint puller set

codice	A	B	C
151 026	55	23	27
	55	28	27
	63	34	27

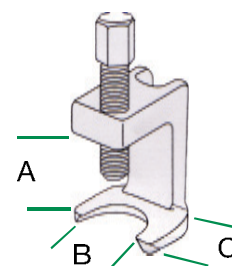

Dati tecnici - Informativa

Utensili per l'estrazione di tiranti sospensioni e perni tiranti sterzo, da bracci di comando, da assali e dallo stabilizzatore. Utilizzo universale per auto e furgoni

Estrattori perni sferici tiranti sterzo auto

Ball joint puller of tierods

acciaio cr. v
cromato

Audi - BMW - Opel - Ford - Saab - Volvo

codice	A	B
151 028	56	28
151 029	63	34

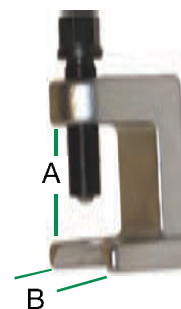

Estrattore perni sferici per Auto & Truck

Truck ball joint separator

Codice	A	B	C	D	E
151 035	25	60	75	94	56
151 036	30	60	75	94	58
151 037	32	92	122	137	72
151 038	39	60	82	130	80

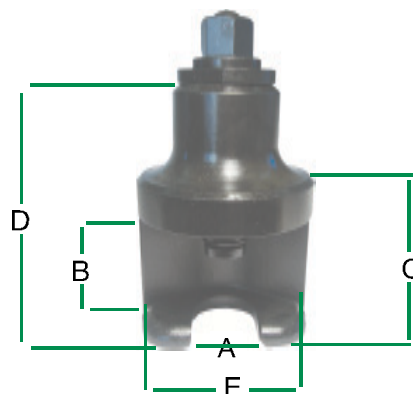

Estrattori perni sferici tiranti sterzo Auto e Autocarro

Ball joint puller of tierods

Codice	A	B	C
151 041	35	18	Spessore piede 9
151 042	44	24	Spessore piede 10
151 043	56	29	Spessore piede 11
151 044	80	39	Spessore piede 18
151 047	56	29	Piede sottile 5
151 048	80	39	Piede sottile 11

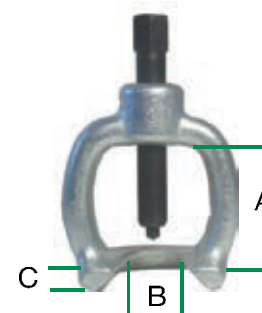

Estrattore perni tiranti sterzo Camion

Extractor pivots connecting rods steering gear fot truck

acciaio cr. v
cromato

codice	A	B	C
151 050	100	52	77



Estrattore perni sferici tiranti sterzo auto

Ball joint puller of tierods

Codice	A	B	C
151 069	40 - 60	24	60
151 090	60	24	60

Ricambi - Spare parts

Per codice	Vite	Vite laterale
151 069		151 070
151 090	151 091	151 092

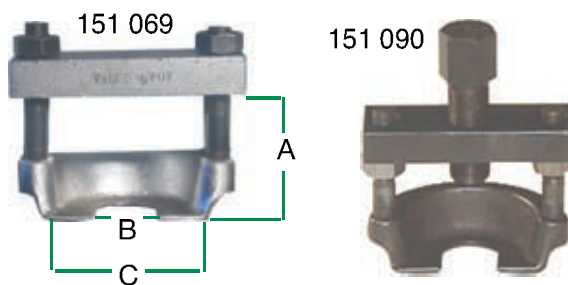

Estrattore perni sferici tiranti sterzo auto

Ball joint puller of tierods



codice	A	B
151 093	48	17
151 094	48	22

Ricambi - Spare parts



Vite
151 095



Estrattore perni tiranti sterzo auto

Extractor pivots connecting rods steering gear

Made in Germany	codice	A
	151 096 00	145
	151 096 10	115

151 096 00

151 096 10

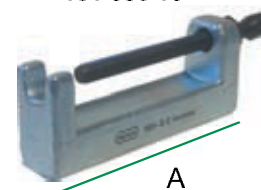
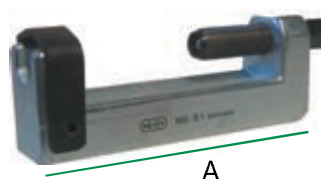

Dati tecnici - Informative

Audi A4 - A6 - A8 4WD - VW Passat - Passat syncro - Skoda



Estrattore perni sferici tiranti sterzo auto

Ball joint puller of tierods



Codice	A	B
151 101	30 - 50	18 - 22

Ricambi - Spare parts



Vite
151 102



Perno Centrale
151 103



Spina
151 104

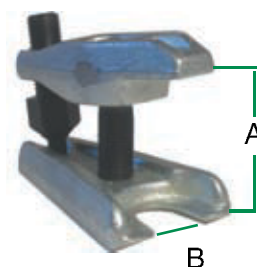

Estrattore perni sferici - Sprinter -

Sprinter ball joint separator

Made in Germany

Codice	A	B	C	D	E
151 118	35	60	93	135	90

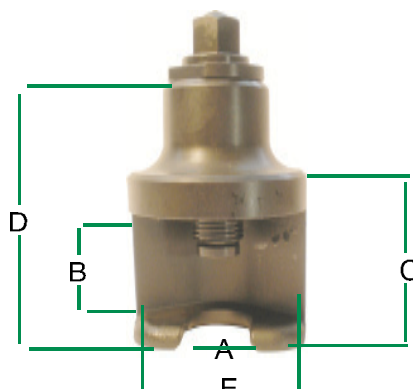

Estrattore / inseritore snodi sferici Mercedes

Benz steering torque rod joint installer / remover



Codice	A	B
151 120	48	34



Dati tecnici - Informative

Mercedes W 171 / W 203 / W 209



Estrattore snodi sferici su braccetti Mercedes

Bena drag link puller

Codice	A	B
151 122	200	21

Dati tecnici - Informative

Mercedes W 123 - W 124 - W 126 - W 201 - W 202 - W 140

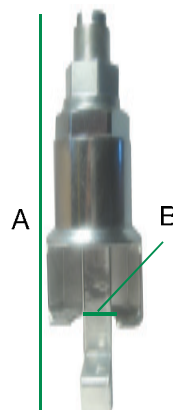

Estrattore snodi sferici su mozzi

Universal ball joint separator

Codice	A	B
151 124	40	21

Dati tecnici - Informative

Mercedes 201 - 123 - 124 - 126 - 129 etc...
Vw - Audi - Bmw - Citroen - Fiat - Ford - Mitsbischi - Opel -
Peugeot - Renault - Saab - Volvo - Japanese car etc..



Estrattore perni sfera tiranti sterzo - Ganascia sottile - Extractor sphere pivots puller of gear

Codice	A	B
151 151	30 - 40	19,5

Ricambi - Spare parts



Vite

Spina

151 152

151 153

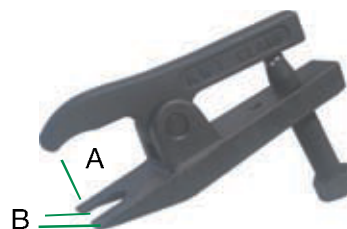

Estrattore perni sfera a doppia posizione Ball joint puller

Codice	A	B	C
151 155	Max 58	21	155

Ricambi - Spare parts



Vite

Spina

151 156

151 157

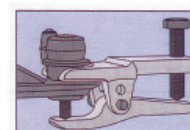
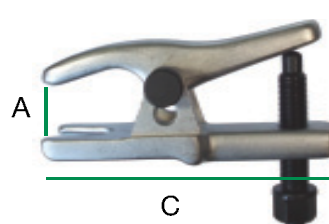

Estrattori perni a sfera con prolunga

Extractor spherical pivot with prolong

Codice	A	B	C
151 158	50 - 80	22	160

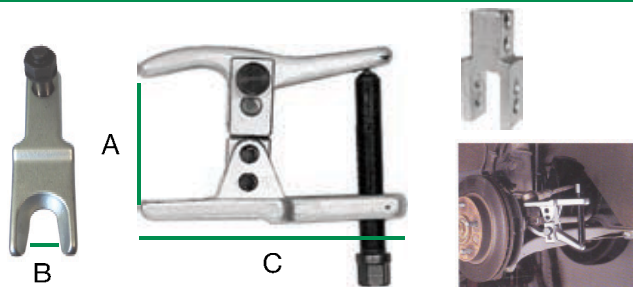

Estrattore perni sfera a ganascia sottile. Il fulcro arretrato agevola l'accesso al perno

Codice	A	B
151 159	25 - 50	21



Estrattore perni sfera tiranti sterzo truck - Universal Ball joint extractor

acciaio cr. v

codice	A	B
151 160	160	32
151 164	160	45

Ricambi - Spare parts

Per codice	Vite	Perno Centrale	Spina
151 160	151 160 01	151 160 02	151 160 03
151 164	Nd	Nd	Nd

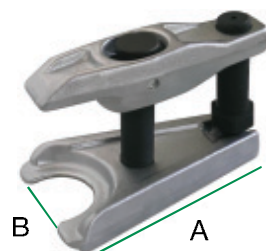

Estrattore universale per perni sfera - Universal extractor spherical pivots

acciaio cr. v

codice	A	B
151 165	190	30

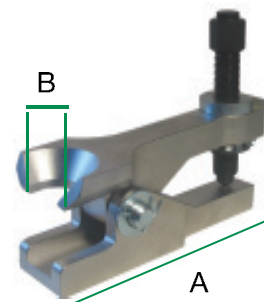

Estrattori perni sferici "Truck" con 5 ganasce intercambiabili - Quick-change ball joint remover

Ball joint puller of tierods

151 167	A	B	C
	mm 55	mm 20	175
	mm 55	mm 22	175
	mm 55	mm 24	175
	mm 55	mm 27	175
	mm 55	mm 30	175

Apertura Max. mm 100
Lunghezza vite di spinta mm 125

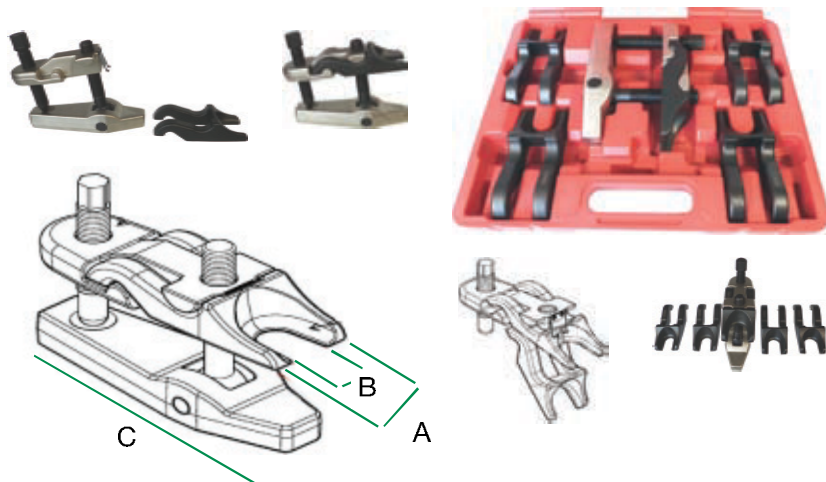

Estrattore perni Tiranti sterzo TRUCK - Extractor pivots connecting rods steering gear for truck

Codice	A	B	C
151 168 00	75	35	210

Ricambi - Spare parts



Vite

151 168 01



Spina

151 168 02

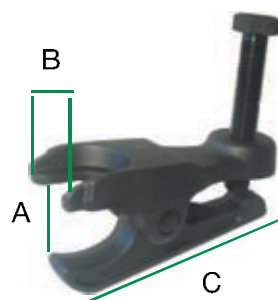

Estattori perni sferici TRUCK - Rovesciabile

Extractor pivots connecting rods for truck
acciaio forgiato

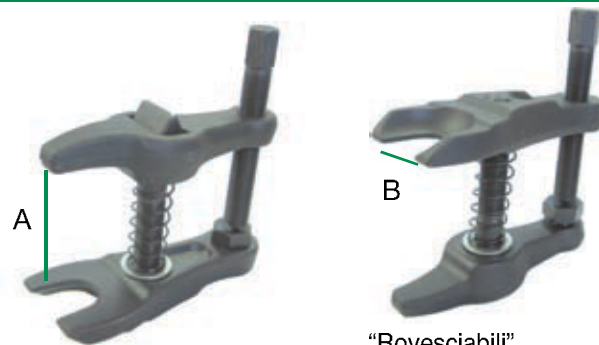

Codice	A	B
151 169	Min 65 - Max 125	42

Estrattore perni sferici tiranti sterzo AUTO - Ball joint puller of tierods

Codice	A	B
151 170	400	18
151 171	295	24

151 170



151 171



Estrattore perni sferici tiranti sterzo Truck - Ball joint puller of tierods for truck



codice	A	B
151 174	290	27
151 175	290	32
151 176	290	42



Estrattore perni sferici tiranti sterzo

Ball joint puller of tierods

codice	A	B
151 182	270	16
151 184	280	20

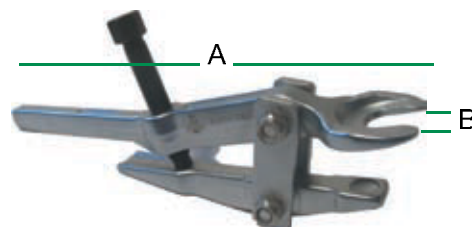

Leva ritegno trapezi durante la lavorazione su sospensioni, semiassse, cambio etc...

Lever for the swinging arm head removal

codice	A
152 000	750

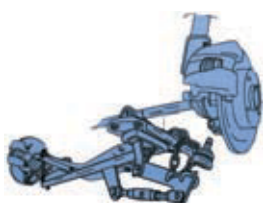

Mandrino autoserrante per estrazione prigionieri

Codice	Ø	Att:	Esagono 1	Esagono 2
161 000	6 - 12	3/8"	24	36



Estrattori prigionieri

Stud puller

Codice	mm	A	Esagono
161 003	16 - 24	65	34
161 005	5 - 20	52	22

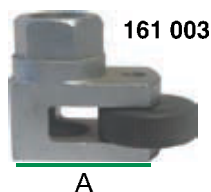

Estrattori prigionieri

Stud puller

Codice	mm	A
161 006	2 - 12	170
161 007	2 - 18	170
161 008	12 - 26	170

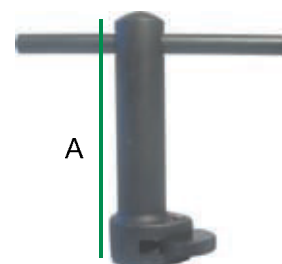

Set estrattori prigionieri a bussola

Stud puller

Codice	mm		
161 015	6 / 8 / 10 / 12	in valigetta	pz 4
161 016	5 / 6 / 7 / 8 / 10 / 12 / 14	in valigetta	pz 7



Estrattori prigionieri a bussola - Stud puller

Codice	Metrici	Codice	POLLICI
161 01805	mm 5 x 60	161 019 06	1 / 4"
161 01806	mm 6 x 60	161 019 08	5 / 16"
161 01807	mm 7 x 60	161 019 09	3 / 8"
161 01808	mm 8 x 60	161 019 11	7 / 16"
161 01810	mm 10 x 68	161 019 13	1 / 2"
161 01812	mm 12 x 68		
161 01814	mm 14 x 68		



Set estrattori prigionieri a bussola

Stud puller

Codice	mm		
161 020	3 / 18	in valigetta	pz 5



Set estrattori per viti spezzate con attacco 3/8"

acciaio cr. mo.
brunito



Codice	Att	A mm		
161 022	3/8"	2 - 3 - 4 - 6 - 8	Su binario	Pz 5

Set estrattori da mm 2 a mm 10 per viti spezzate da mm 5 a mm 20

Set screw broken from mm 2 to mm 10

acciaio cr. mo.
brunito



Codice	Attacco	A mm		
161 023	3/8"	2 - 3 - 4 - 6 - 8 - 10	In valigetta	Pz 6

Kit su binario estrattori viti spezzate - Twist type screw extractor set

acciaio cr. mo.
brunito



Codice	Attacco	A mm		
161 024	1/2"	8 - 10 - 12 - 14	Su binario	Pz 4

Set estrattori per viti spezzate / Per viti da mm 5 a mm 16

Codice		
161 025	in valigetta	pz 25



Composizione - Composition

5 Punte - 10 Guide - 5 Estrattori con guida

Set estrattori per tubi spezzati ad espansione - Internal pipe wrench set

Codice		
161 030	in valigetta	pz 6



Composizione - Composition

mm 6 - 1/8" / mm 8 - 1/4" / mm 10 - 3/8" / mm 15 - 1/2" / mm 20 - 3/4" / mm 25 - 1"

NOTE