

Multipresa a ciabatta due poli più terra

Socket 2 pins + earth



517 001 250V 10-16 A - 3x1,5 mm² 1,5 mt

Multipresa a ciabatta due poli più terra e Schuko

Socket 2 pins + earth+Schuko



517 002 250V 10-16 A - 3x1,5 mm² 1,5 mt

Multipresa a ciabatta due poli più terra e Schuko con interruttore

Socket 2 pins + earth+Schuko with switch



517 003 250V 10-16 A - 3x1,5 mm² 1,5 mt

Avvolgicavo a due prese due poli più terra

Reel for electric cable with sockets 2 pins + earth



517 010 250V 10-16 A - 3x1,5 mm² 10 mt

Avvolgicavo a 5 prese

Reel for electric cable with sockets 5 pins



517 011 avvolgicavo

Dati tecnici - Informative

- 4 prese a due poli+terra 16A Bipasso
- 1 presa SCHUKO
- Cavo Mt. 15 / Sez. mm 3 x 1,50
- Tamburo Ø 245 mm + disgiuntore
- 240V 10 / 16 A

Avvolgicavo due poli più terra e Schuko

Reel for electric cable with sockets 2 pins + earth+Schuko



517 012 250V 10-16 A 3x1,5 mm² - 10 mt

Avvolgicavo due poli più terra e Schuko

Reel for electric cable with sockets 2 pins + earth+Schuko



517 022 250V 10-16 A - 3x1,5 mm² 50 mt

Avvolgicavo Onda Industriale con disgiuntore

Reel for electric cable with sockets 5 pins



517 028 Mt. 20 517 029 Mt. 30

Dati tecnici - Informative

- F. 3 x 2,5 - 2 Prese 2 poli + Terra
- 16A - 220V - CEE blu + 1
- Bipasso / standard tedesco + Disgiuntore
- Tamburo in materiale plastico
- Resistente agli urti ed escursioni termiche

Presca volante CEE IMQ con ghiera serracavo e sgancio a baionetta



517 060 2 Poli + Terra 220V - 16A

517 060 01 3 Poli + Terra 380V - 16A

Spina diritta volante CEE IMQ con ghiera serracavo e sgancio a baionetta

Electrical plug CEE IMQ with 2 wire + Ground



517 063 2 Poli + Terra 220V - 16A

517 063 01 3 Poli + Terra 400V - 16A

Spina mobile industriale a bassissima tensione



517 065

Dati tecnici - Informativi

Numero di poli: 2 - Corrente nominale: 16A
Tensione nominale: 24V - IP 44

Adattatore volante spina due poli bipasso più terra CEE IMQ e presa due poli più terra e Schuko

Adaptor with all-weather 2 pins+earth male socket and 2 pins + earth female socket + Schuko



517 071 220 V - 16 A

Adattatore volante spina Schuko e presa CEE IMQ a due poli più terra

Adaptor with male Schuko and all-weather 2 pins+earth female socket



517 072 220 V - 16 A

Adattatore volante spina industriale due poli e terra con presa CEE IMQ a due poli più terra

Adaptor with male 2 pins+earth and all-weather 2 pins+earth



517 073 220 V - 16 A

Adattatore con spina CEE e 2 prese bivalenti CEE IMQ

Adapter with electrical plug CEE and 2 bivalent tap CEE



517 074 220V - 16A

Adattatore volante CEE IMQ spina 2P+terra - 2 prese bipasso - 1 presa SCHUKO con presa bipasso



517 075 220V - 16A

Adattatore con spina CEE - 2P+terra 1P CEE-1P SCUKO con P bipasso IMP



517 079 220V - 16A

Adattatore civile con spina 2 poli + terra e 2 prese bipasso e SHUKO



517 080 16A - CEE blu - IP44

Adattatore civile con spina 2 poli + terra e 2 prese 2 poli + terra

Electrical plug adaptor



517 081 16A - CEE Blu - IP44

NOTE



Aspira-solidi e liquidi INOX con comoda presa

Professional wet & dry



Con presa elettroutensili

517 240 Completo di accessori - Lt. 24

Ricambi - Spare parts

517 240 01 Filtro AZZURRO da utilizzare da solo per l'acqua oppure in coppia con filtro in panno per le polveri

517 240 02 Filtro in panno

Adattatori opzionali - Optional adaptors



517 240 03 Filtro a cartuccia

Dati tecnici - Informative

Alimentazione: Volt 230
 Portata: 220 m3/h
 Depressione: 1850 mm H2O
 Potenza: Watt 1300 - 1500 max
 Potenza PE: Watt 1200 max
 Tipo motore: By pass
 Cavo elettrico: Mt 5
 Peso: Kg 8
 Emissioni acustiche: 72 (dB) A
 Dimensione imballo: 380 x 380 x 680

Accessori di serie - Accessories

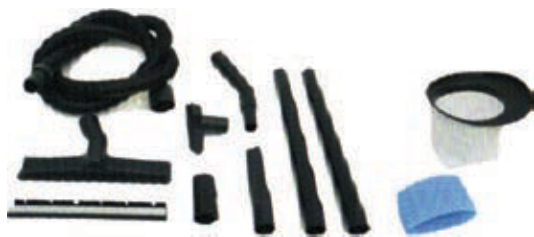

Diametro 36 = Flex 2,5 mt + 2 tubi rigidi + lancia + Bocchetta + Impugnatura + Spazzola accessorio polvere / liquidi + Presa elettroutensili.



Made in Italy

Aspira-polvere e liquidi con sistema di pulizia del filtro + presa per elettroutensili

Professional wet & dry



Presse elettroutensili

517 250 Completo di accessori - Lt. 25

Ricambi - Spare parts

517 250 01 Cartuccia

517 250 02 Kit 4 sacchetti + filtro liquidi

Dati tecnici - Informative

Alimentazione	Volt 230
Portata Aria	l / min 3600
Depressione	190 /19
Potenza	Watt 1400
Dimensioni	mm Ø 380 x 545
Capacità serbatoio	Lt. 25
Cavo	mt. 5

SISTEMA DI PULIZIA FILTRO

Adatto per l'aspirazione di polveri fini, dove il continuo intasamento del filtro crea problemi di interruzione del lavoro per la pulizia ed il ripristino degli stessi. E' sufficienteappare l'aspirazione e premere il pulsante posto sulla testata dell'aspiratore per far rientrare l'aria nel fusto, che passando dal filtro in direzione opposta permette la decantazione dello sporco aggrappato allo stesso ripristinando la massima aspirazione

Accessori - Accessories

Tubo flessibile - Prolunga - Lancia - Bocchetta pavimenti girevole - Bocchetta universal - Spazzola a pennello - Filtro a sacchetto + filtro bagnato - filtro cartuccia

NOTE



Aspira-polvere e liquidi con sistema di pulizia del filtro + presa per elettrodomestici

Professional wet & dry



Presa elettrodomestici

517 260 Completo di accessori - Lt. 20 - INOX

Ricambi - Spare parts

517 250 01 Cartuccia

517 250 02 Kit 4 sacchetti + filtro liquidi

Dati tecnici - Informative

Alimentazione	Volt 230
Portata Aria	l / min 3600
Depressione	180 /18
Potenza	Watt 1300
Dimensioni	mm Ø 380 x 485
Capacità serbatoio	Lt. 20
Cavo	mt. 5

SISTEMA DI PULIZIA FILTRO

Adatto per l'aspirazione di polveri fini, dove il continuo intasamento del filtro crea problemi di interruzione del lavoro per la pulizia ed il ripristino degli stessi. E' sufficiente tappare l'aspirazione e premere il pulsante posto sulla testata dell'aspiratore per far rientrare l'aria nel fusto, che passando dal filtro in direzione opposta permette la decantazione dello sporco aggrappato allo stesso ripristinando la massima aspirazione

Accessori - Accessories

Tubo flessibile - Prolunga - Bocchetta pavimenti - Lancia - Bocchetta universal - Spazzola a pennello - Filtro a sacchetto + filtro bagnato - filtro cartuccia

NOTE



Aspira-solidi e liquidi, fusto INOX da 30Lt, funzione soffiante e presa elettrodomestici

Professional wet & dry



Con presa elettrodomestici

517 270 Completo di accessori - Lt. 30

Ricambi - Spare parts

517 250 01 Cartuccia

517 250 02 Kit 4 sacchetti + filtro liquidi

Dati tecnici - Informative

Alimentazione:	Volt 230
Portata:	55l / sec
Depressione:	20 kpa
Potenza:	Watt 1400 max
Tipo motore:	Monostadio - By pass
Cavo elettrico:	Mt 4
Emissioni acustiche:	72 (dB) A
Peso:	Kg 12 - Dimensione imballo: 380 x 360 x 680

Accessori di serie - Accessories

Tubo flessibile Ø 36 x mt. 2,5, Impugnatura anatomica, Tubo telescopico cromatao, Corpo spazzola con accessorio combinato, Lancia - pennello, Filtro tessuto - Filtro spugna



Aspirapolvere e liquidi TECNOCLEAR

Vacuum cleaner for liquid



517 300

Alimentazione: 230 Volt
 Frequenza 50 Hz
 Power 1.200 Watt
 Consumo Aria 16.5 mc/h
 Capacità 20 Lt
 Peso Kg. 4,3

Aspiratore elettrico monofase per polveri e liquidi 9 accessori

Vacuum cleaner for liquid



517 311

INDUSTRIAL 30
 230 Volt - 1000 Watt
 Portata aria / Air Consumption 165 m³/h

Aspira-cenere Faustino, con bocchetta in metallo resistente al calore

Professional wet & dry



517 306

Aspiratore elettrico monofase per polveri e liquidi 9 accessori

Vacuum cleaner for liquid



517 312

INDUSTRIAL 50
 230 Volt - 1350 Watt
 Portata aria 220 m³/h

NB: NON UTILIZZARE CON CENERE ANCORA ROVENTE

Ricambi - Spare parts

517 306 01 Filtri multistrato di ricambio

Dati tecnici - Informative

Tensione nominale V 230
 Frequenza Hz 50 / 60
 Potenza IEC W 500
 Capienza l nom. 18
 Depressione KPa ca. 17
 Portata d'aria l/sec. ca. 38

Accessori - Accessories

Tubo flessibile con manicotti girevoli Mt. 2,5
 Bocchetta a lancia in metallo mm 340
 Filtro multistrato lavabile

NOTE

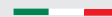

Aspira solidi e liquidi professionale a 3 motori

Professional wet & dry 3 motors

Dotato di fusto a sistema basculante per facilitarne lo svuotamento - in particolare dei liquidi - dopo il lavoro



517 315 INOX - Litri 70

Ricambi - Spare parts



517 315 05 Filtro idrorepellente

Dati tecnici - Informative

- 3 Motori x (1100W - 1300W Max)
- Cavo elettrico Mt 7,5
- Peso 18 Kg
- Potenza 3 x 1100 W - Max 1300 W
- Motore By pass Bi-stadio

Accessori - Accessories



Tubo flessibile
Ø 45 x 4 mt.



Tubi rigidi
cromati Ø 45



Lancia Ø 45



Pennello Ø 45



Corpo spazzola Ø 45



Accessorio
liquidi Ø 45



Accessorio
solidi Ø 45



Filtro in panno trattato per resistere al recupero di eventuali solidi umidi (non utilizzare per i liquidi)



Filtro idrorepellente

Coperchi e filtri di ricambio per aspiratori

Cover for vacuum filter



517 321 Solo cartuccia filtro per 517 300 - 311

517 322 Solo cartuccia filtro per 517 312

517 321 01 Solo coperchio per 517 321

517 322 01 Solo coperchio per 517 322

Sacchetto di carta orizzontale per Tecnoclear

Pouch of horizontal paper for Competitor



517 323 Conf. 5+1

Sacchetto ricambio

Exchange bag



517 327 Carta per 517 311-517 312 05 pcs

517 328 PPL per 517 312 01 pcs

Supporto multi direzionale per trapano

Articulated drill holder



517 451 Diam 43 mm

Morsa parallela da banco in ghisa ganasce riportate in acciaio Cr.V.-Mn ganascia posteriore scorrevole

Parallel jaw bench vice cast iron body forged jaws



520 002 100 mm

520 004 150 mm

520 003 120 mm

Morsa parallela da banco "ETERNA" in acciaio con ganasce riportate in acciaio Cr.V.-Mn ganascia posteriore scorrevole

Parallel jaw bench vice cast steel body forged jaws



520 012	100 mm	520 014	150 mm
520 013	120 mm		

Morsa parallela da banco in acciaio forgiato, con ganasce per tubi, doppia guida

Acciaio forgiato



	mm	Kg
520 016	100	7,5
520 017	125	11,5
520 018	150	18,5

Morsa parallela da banco in acciaio con ganasce corpo unico temprate rettificate doppia guida registrabile

Parallel jaw bench vice cast steel body forged jaws

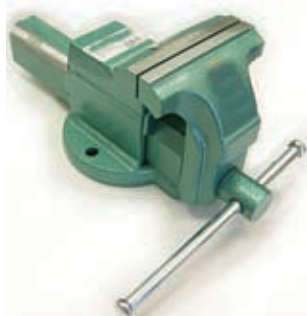

520 021	100 mm	520 023	150 mm
520 022	125 mm	520 024	165 mm

Morsa parallela da banco in acciaio con ganasce corpo unico temprate rettificate registrazione a mezzo cardano

Parallel jaw bench vice cast steel body forged jaws



520 031	100 mm	520 033	150 mm
520 032	125 mm		

Morsa parallela da banco in acciaio import

Parallel jaw bench vice cast steel body forged jaws



520 041	80 mm	520 043	125 mm
520 042	100 mm	520 044	150 mm

Morsa parallela da trapano in ghisa ganasce prismatiche in acciaio temperato

Parallel jaw drill vice cast iron body tempered jaws

Made in italy



520 046	100 mm	520 047	120 mm
---------	--------	---------	--------

Morsa di precisione in acciaio temprato rettificato

IMPORT

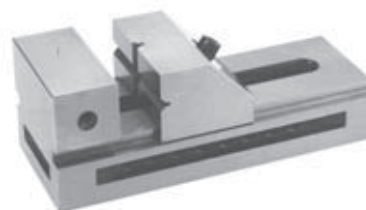

520 056	apertura mm 100 - mm	73x190x67h
520 057	apertura mm 125 - mm	100x245x90h

Coppia copriganasce magnetiche in alluminio

Protective magnetic jaws on aluminium



520 061	80-105 mm	520 063	130-150 mm
520 062	110-125 mm		

Coppia copriganasce magnetiche in fibra

Protective magnetic jaws on fiber

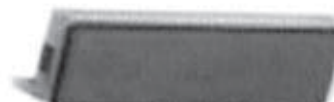

520 065	80-105 mm	520 067	130-150 mm
520 066	110-125 mm		

Coppia ganasce in alluminio



520 074	100 mm	520 076	150 mm
520 075	125 mm		

Base girevole a 360° per morsa



520 080	Per morsa 520 021
520 081	Per morsa 520 022
520 082	Per morsa 520 023 - 24

Incudine KG 10 in Acciaio indurito C45

10 KG hardened steel anvil C45

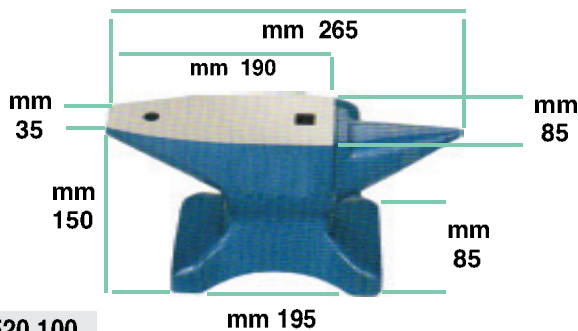

520 100

Incudine

Steel anvil



520 104	20 Kg	520 107	50 Kg
520 105	30 Kg	520 108	60 Kg
520 106	40 Kg		

Paranco ad ingranaggi multipli con metri 3 di catena per carico e manovra

Pulley block for lifting



520 131	500 Kg	520 135	3000 Kg
520 132	1000 Kg	520 136	5000 Kg
520 133	1500 Kg	520 137	10000 Kg
520 134	2000 Kg		

Catena di carico per paranco

Chain for pulley block



520 141	un metro	500 Kg
520 142	un metro	1000 Kg
520 143	un metro	1500 Kg
520 144	un metro	2000 Kg
520 145	un metro	3000 Kg
520 146	un metro	5000 Kg
520 147	un metro	10000 Kg

Catena di manovra per paranco

Chain thin



520 149	un metro
---------	----------

Tiranti in fune acciaio con asola e gancio coefficiente di sicurezza 5:1

Huk holders

Nuovo Modello



520 151	Diam. 8 mm x 440 mm	500 Kg
520 152	Diam. 10 mm x 530 mm	1000 Kg
520 153	Diam. 12 mm x 600 mm	1500 Kg
520 154	Diam. 14 mm x 800 mm	2000 Kg
520 155	Diam. 16 mm x 900 mm	2500 Kg
520 156	Diam. 18 mm x 900 mm	3000 Kg

**Tiranti in fune a due bracci con asola e gancio
coefficiente di sicurezza 5:1**

Huk holders

Nuovo Modello



520 161	Diam. 8 mm x 440 mm	1000 Kg
520 162	Diam. 10 mm x 530 mm	2000 Kg
520 163	Diam. 12 mm x 600 mm	3000 Kg
520 164	Diam. 14 mm x 800 mm	4000 Kg
520 165	Diam. 16 mm x 900 mm	5000 Kg

FORNIBILI FUNI PIÙ LUNGHE CON PIÙ BRACCI

Tiranti in fune a due bracci per recupero auto e furgoni; coefficiente di sicurezza 5:1

Huk holders



520 168	Lunghezza 120 cm	3000 Kg
520 169	Lunghezza 120 cm	5000 Kg

Carrello porta paranco a quattro ruote a spinta

Four wheels truck for lift

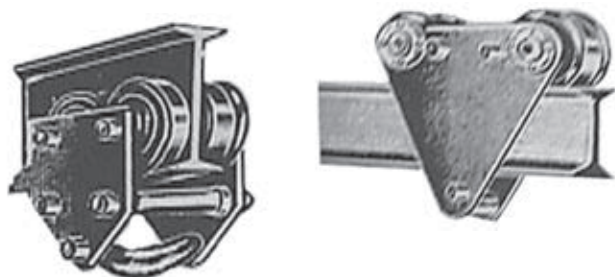

520 171	250 Kg	520 174	1500 Kg
520 172	500 Kg	520 175	2000 Kg
520 173	1000 Kg	520 176	3000 Kg

Carrello porta paranco a quattro ruote su cuscinetti

Four wheels truck for lift

520 181	250 Kg	520 185	2000 Kg
520 182	500 Kg	520 186	3000 Kg
520 183	1000 Kg	520 187	4000 Kg
520 184	1500 Kg	520 188	5000 Kg



Argano manuale a vite elicoidale con protezione CE

Wall winch

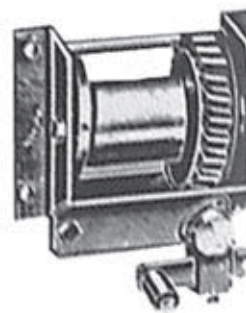

520 191	250 Kg	520 194	1500 Kg
520 192	500 Kg	520 195	2000 Kg
520 193	1000 Kg		

Argano manuale ad ingranaggi cilindrici con protezione CE

Wall winch with cilindric gear



520 201	Per fune Diam. 4 mm	150 Kg
520 202	Per fune Diam. 6 mm	250 Kg
520 203	Per fune Diam. 8 mm	500 Kg
520 204	Per fune Diam. 10 mm	1000 Kg
520 205	Per fune Diam. 12 mm	1500 Kg

Argani elettrici in corrente continua 12 V

12V electric winch - direct current



520 220



520 222

Dati tecnici - Informative

Velocità:	1.3 - 3.2 m/min	1.5 - 2.1 m/mn
Motore:	12V - 0,7Kw - 0,9hp	12V - 1,3 Kw - 1,8 hp
Riduzione:	153:1	462:1
Cavo:	mm4 x mt 15	mm 5,4 x mt 16
Tamburo:	mm 31,5 x 73	mm 50 x 76
Peso:	Kg 6,7	Kg 16

520 220	Tiro nominale in orizzontale Kg 450
520 221	Pulsantiera di ricambio per argano Kg 450

520 222	Tiro nominale in orizzontale Kg 1800
520 223	Pulsantiera di ricambio per argano kg 1800

Pressa idraulica manuale

Hidraulic press with double pump With accessories

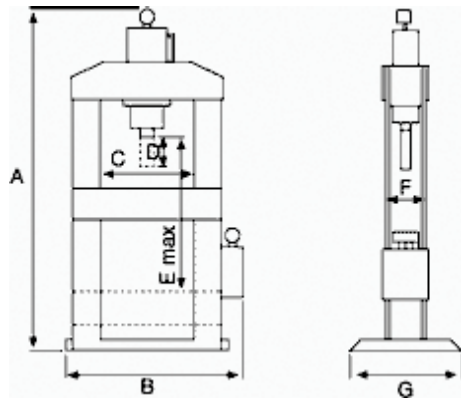

Pressa idraulica manuale con pompa a due velocità di lavoro con rientro automatico del pistone con due prismi a V, piatto e manometro per il controllo della pressione di esercizio.

Cod.	Ton.	A	B	C	D	E	F	G	Peso
520 301	10 t	1300	860	550	180	550	125	500	100
520 302	10 t	1900	870	550	180	1100	125	500	115
520 303	15 t	1950	930	570	180	1100	150	500	145
520 304	20 t	2000	1000	620	180	1150	150	500	157
520 305	30 t	2130	1200	700	200	1150	180	650	250
520 306	50 t	2300	1300	800	200	1100	180	750	385
520 307	70 t	2350	1350	920	200	1200	230	750	600
520 308	100 t	2400	1530	1000	200	1280	270	850	865

I modelli 520 305-306-307-308 sono dotati di argano per sollevamento piano di lavoro.
 Models 520 305-306-307-308 are equipped with flat work holder.

NOTE



Gru idraulica pieghevole con pompa a doppio effetto

Lift for engine

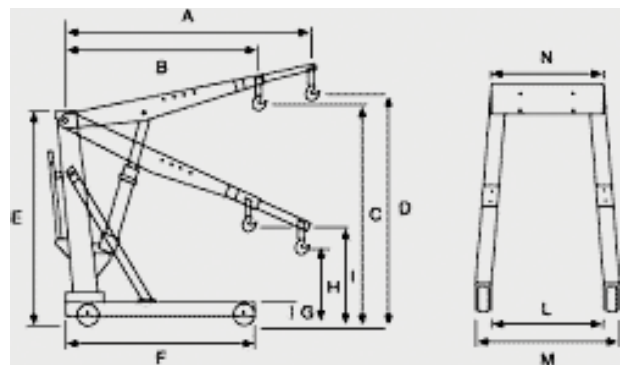

520 321 Kg. 500-400-250-150 Peso 73 Kg.

A	B	C	D	E	F	G	H	I	L	M	N
1200	930	2050	2200	1550	1300	130	380	480	660	790	450

520 322 Kg. 1000-800-500-300 Peso 100 Kg.

A	B	C	D	E	F	G	H	I	L	M	N
1400	1130	2280	2450	1650	1500	145	350	500	800	940	550

NOTE



Gru idraulica leggera con pompa a doppio effetto

Lift for engine

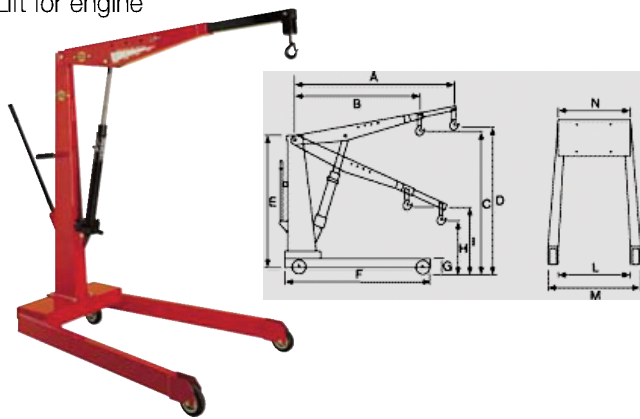

520 325 Kg . 500-400-250-150 Peso 65 Kg

A	B	C	D	E	F	G	H	I	L	M	N
1340	1040	2120	2340	1680	1305	155	340	560	785	900	600

520 326 Kg . 1000-800-500-300 Peso 82 Kg.

A	B	C	D	E	F	G	H	I	L	M	N
1540	1235	2490	2730	1720	1530	170	550	725	975	1110	745

520 327 Kg . 1500-1200-800-500 Peso 176 Kg

A	B	C	D	E	F	G	H	I	L	M	N
1815	1370	2630	2975	1865	1690	185	400	700	880	1015	1000

520 328 Kg . 2000-1500-1000-600 Peso 217 Kg.

A	B	C	D	E	F	G	H	I	L	M	N
1910	1460	2855	3210	1990	1910	215	420	725	955	1120	1100

Crik idraulici a carrello su quattro ruote, due direttrici e due piroettanti, manico smontabile, valvola di fine corsa automatica

Little trolley jacks

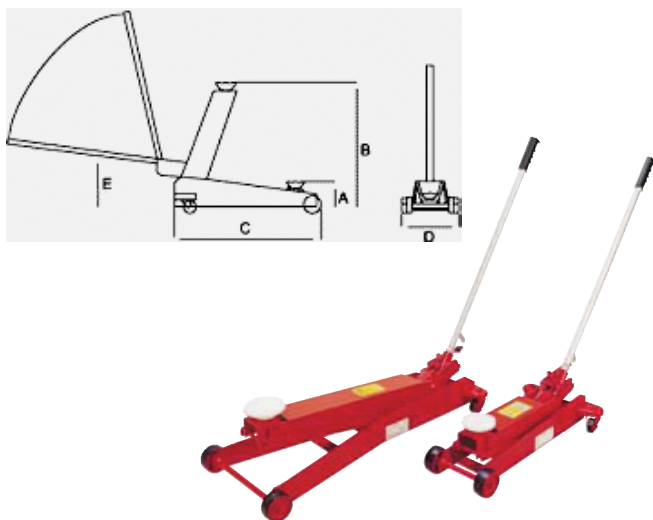

Cod.	Ton.	A	B	C	D	E	Peso
520 331	0.8	100	410	580	280	125	14
520 332	1.2	120	540	645	330	160	29
520 333	1.5	120	540	645	330	160	30
520 334	2.5	130	540	700	340	170	36

Cric a carrello 2.25 Tonnellate. CE

Hidraulic trolley jack 2 1/4 Tons



520 336 Cric

Dati tecnici - Informative

Alzata Min. 145 - Max 500 mm
 Dimensioni 695x344x180mm
 Peso 38 Kg

Cric a carrello in alluminio con ruota frontale larga

Hydraulic trolley alluminium jack



520 337 Cric

Dati tecnici - Informative

- Portata: 1,5 Ton
- Alzata minima piattello: mm 85
- Alzata massima piattello: mm 445
- Peso: Kg 24
- NB: I cric a carrello sono studiati per sollevare la vettura e non per tenerla sollevata per lunghi periodi, (lavoro dedicato ai cavalletti sottovettura, vedi pag 350, 637, 770) questo potrebbe comportare l'indebolimento delle guarnizioni e la perdita della garanzia

Crik idraulici a carrello con doppie ruote

Little trolley jacks wulkollan

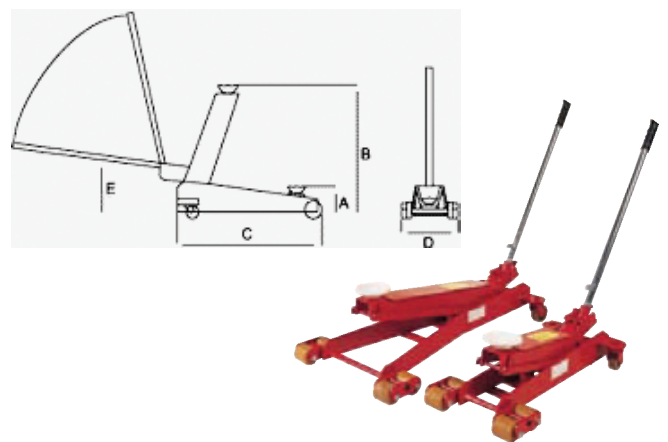

Crik idraulici a carrello con doppie ruote in wulkollan per poter muovere le vetture anche su grigliati grazie ai doppi rulli basculanti anteriori. Con valvola automatica di fine corsa e manico smontabile

Cod.	Ton.	A	B	C	D	E	Peso
520 341	1.5	120	540	705	370	160	32
520 342	2.5	130	550	750	400	170	40
520 343	1.5	130	800	1050	530	170	50

Crik idraulici a carrello normale

Trolley jacks

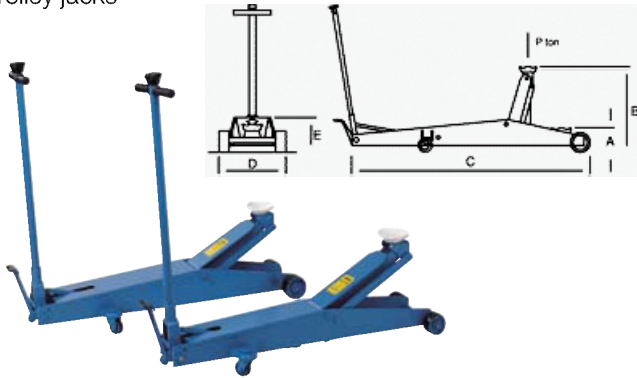

Con valvola limitatrice di carico automatica che evita qualsiasi sovraccarico e con pedale di avvicinamento rapido e valvola di fine corsa automatica.

Cod.	Ton.	A	B	C	D	E	Peso
520 351	1.5	110	520	1100	300	160	40
520 352	2	110	580	1250	300	160	45
520 353	2.5	120	660	1320	340	180	56
520 354	3	120	560	1220	340	185	63
520 355	4	130	580	1400	380	195	70
520 356	5	130	580	1500	380	195	73
520 357	7	160	600	1600	380	220	90

Binda per sollevamento in spazi ridotti con cricco idraulico

Supporting lift



520 390
da 30-180 mm
Kg. 5000
Peso 26 Kg.
100x260x300h mm

Crik a bottiglia con vite di prolunga regolabile con fermo di sicurezza e valvola di fine corsa automatica

Bottle jacks

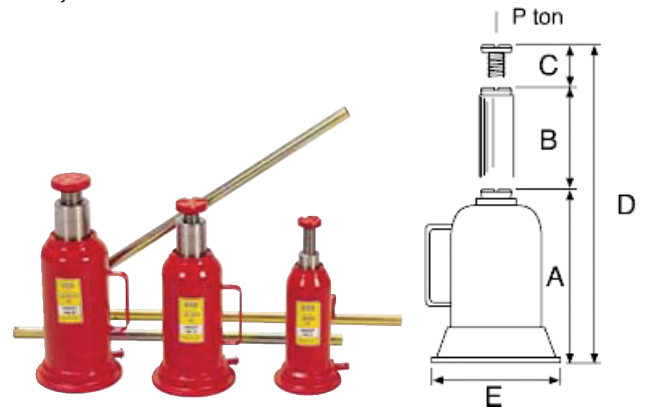

Cod.	Ton.	A	B	C	D	E	Peso
520 400	3	215	150	80	445	140x110	5
520 401	5	220	145	85	450	145x115	6.5
520 402	8	250	180	85	515	145x115	7.5
520 403	10	250	170	100	520	170x140	11.5
520 404	15	270	190	100	560	170x140	13
520 405	20	275	190	100	565	180x150	15.5
520 406	25	280	190	100	570	195x165	18
520 407	30	280	190	100	570	195x165	20
520 408	40	280	190	100	570	235x210	25
520 409	50	280	190	100	570	235x210	30

Cric a bottiglia con vite di prolunga

Hydraulic bottle jack



	Ton	A	B	C	Kg
520 410 05	5	mm 216	mm 127	mm 70	4,3
520 410 10	10	mm 230	mm 150	mm 80	6,5
520 410 15	15	mm 230	mm 150	mm 80	8,4
520 410 20	20	mm 242	mm 150	mm 60	11

NOTE



www.afasupport.it

Crik idraulico a bottiglia a due pistoni telescopici

Bottle jacks tuo pistons

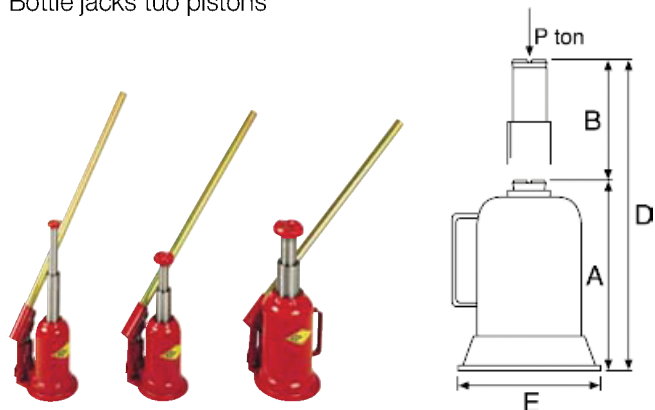

Cod.	Ton.	sul 1° pist	A	B	D	E	Peso
520 411	1.5	4	160	200	360	140x110	5
520 412	3	5	170	210	380	145x115	6
520 413	5	10	225	275	500	170x140	11
520 414	10	20	230	310	540	195x165	14
520 415	15	25	230	310	540	195x165	18
520 416	20	30	230	310	540	195x165	20
520 417	25	40	240	310	550	235x210	22

Martinetto idraulico con comando ad aria

Hydraulic car jack with command to air



Cod.	Ton.	A	B	C	D	E
520 419 01	20	250	288	-	538	160x280
520 419 02	30	252	162	90	504	160x280

Dati tecnici - Informative

- Valvola di sicurezza su discesa
- Valvola di sicurezza sovraccarico
- Pressione d'esercizio 7-10 Bar
- Pompa manuale per emergenza
- Base carellata

Cric idraulici piatti

Hydraulic ram



	Ton	BAR	Min - Max	Kg
520 420 05	5	633	mm 33 - 39	0,65
520 420 10	10	620	mm 44 - 55	1,80
520 420 20	20	633	mm 52 - 63	2,80

Crik idraulico da fossa per motori cambi

Transmission jacks

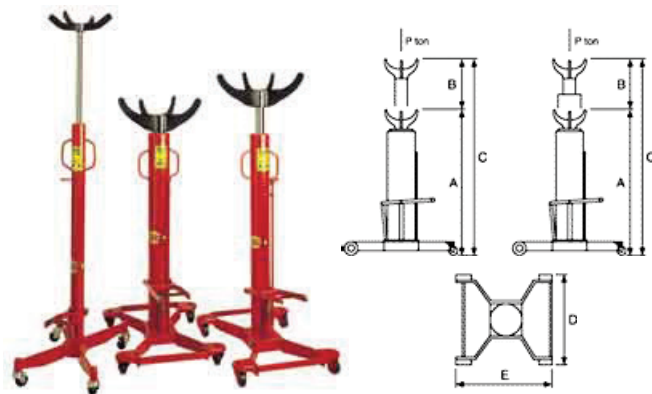

Cod.	Ton.	A	B	C	D	E	Peso
520 421	0.3	1150	850	2000	400	500	25
520 422	0.6	1150	850	2000	490	580	35
520 423	1	1180	800	1980	490	580	50
520 424	1,5	1180	800	1980	490	580	55

Sollevatore mobile ad aria compressa

Mobile lift air



Sollevamento da sotto porta con apposito supporto in dotazione

Sollevamento da sotto ruota

Ideale in carrozzeria e autofficina

Funziona ad aria compressa

Ottima manovrabilità grazie alle sue ruote in teflon ben dimensionate

520 435

Dati tecnici - Informative

Ideale in carrozzeria ed in autofficina per auto furgoni e fuoristrada, nessun motore elettrico, non è idropneumatico, non è presente una pompa rumorosa ed è privo di olio. Permette di inclinare e sollevare la vettura rendendo comode operazioni varie sotto motore e sotto scocca.

Fondi di stuccaggio, saldature, stacco e riattacco di parti di carrozzeria, il tutto consentendo all'operatore di lavorare in posizione verticale.

Essendo la maggior parte delle vetture a trazione anteriore sollevando un veicolo dalla ruota posteriore questo basculerà totalmente in avanti rendendo agevoli i lavori sulla marmitta, o per l'installazione di un impianto GPL.

Facile impegno anche per il montaggio di un gancio traino.

Il sollevamento può essere effettuato anche dal sottoporta con l'apposito supporto in dotazione lasciando libere entrambe le ruote. Le ruote in teflon ben dimensionate permettono un'ottima manovrabilità.

Tempo salita e discesa 45 sec

Altezza massima sollevabile 80 Cm

Portata 1500 Kg

Peso massimo autovettura 3000 Kg

Sollevatore idraulico per moto con pompa a pedale

Hydraulic motorcycle lift table with foot pump



520 440

Dati tecnici - Informative

Capacità di sollevamento: Kg 400
 Dimensioni della piattaforma: mm 1825 x 660
 Altezza di sollevamento: Min 195 - Max 750 mm
 Peso: Kg 173

Rampe in alluminio

Aluminum ramps

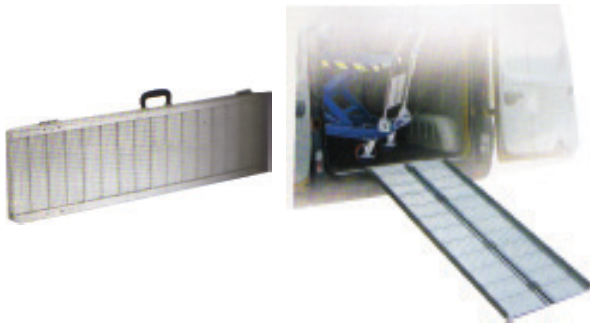

520 445 Portata Kg150 - Dimensioni cm180x73,5 -
 Peso Kg16

520 446 Portata Kg170 - Dimensioni cm150x73,5 -
 Peso Kg13

NOTE



Carrello movimentazione / recupero veicoli sinistrati

Jack for moving damaged car

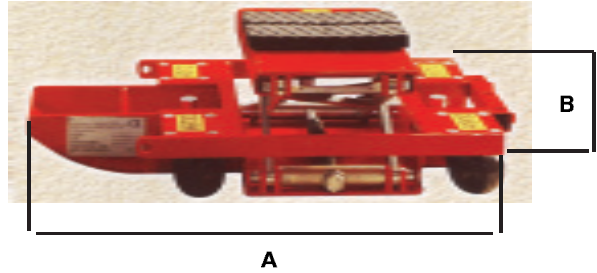

	A	B
520 448	mm 710	mm 450

Dati tecnici - Informative

Portata: Ton. 1,5 Peso: Kg. 35
 Altezza Min: mm 110 Altezza Max: 450
 Nuovo carrello meccanico brevettato per la movimentazione di autovetture (sinistrate e non), una vera e propria svolta innovativa nel campo del soccorso auto. Studiato e realizzato principalmente per essere di supporto e aiuto ai carroattrezzi nel caso di rimozione e recupero di autovetture sinistrate senza ruote. Struttura in acciaio solida e robusta, poggiata su 4 ruote piroettanti che garantiscono un'ottima stabilità in tutte le possibili situazioni di soccorso estremo. La slitta frontale permette la salita del mezzo sinistrato sullo scivolo del carroattrezzo con estrema facilità e sicurezza, evitando ulteriori danneggiamenti. Il carrello viene fornito di chiave meccanica a cricchetto con bussola esagonale per l'alzata e la discesa del piano d'appoggio dotato di due tamponi in gomma da 20 mm adatti per ogni tipo di vettura. Il carrello può essere usato per la movimentazione di veicolo all'interno dell'officina con notevole facilità e senza sforzo.

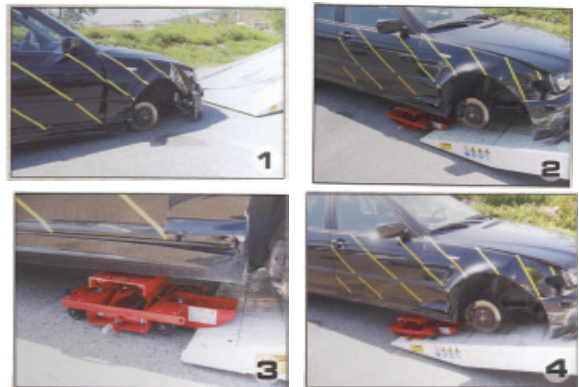

Supporto a culla registrabile per smontaggio motori da applicare al crik da fossa

Engine holder for transmission jack



520 461 Universale

“ORBITAL” per smontare e rimontare il cambio con rapidità e sicurezza



Orbital
Regolazione tramite 2 tenditori su 2 assi.
Movimento telescopico delle traverse di sostegno con blocco

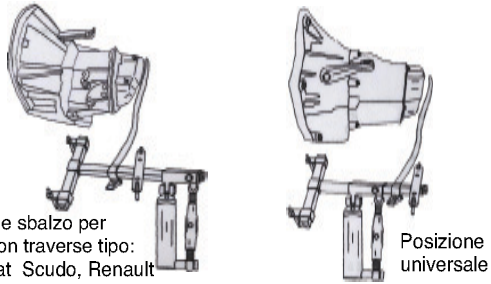

Posizione sbalzo per motori con traverse tipo: Opel, Fiat Scudo, Renault

Posizione universale

520 470

Adattatori opzionali - Optional adaptor

520 470 01 Flangia

Flangia per fissaggio cambio tipo: Citroen Evasion - Peugeot 806
Fiat Scudo - Fiat Ulisse

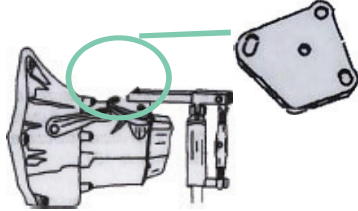

Crik meccanico a pantografo

Service jacks



520 501 Fiat Uno-Y10

520 502 Fiat Tipo

520 503 Fiat Bravo Marea

Crik meccanico a parallelogramma con chiave di manovra con cricchetto

Service jacks



520 505 10 Qli

520 506 15 Qli

Tampone per ponte sollevamento

“Long-Life” rubber block for cars elevator



Consigliato per ponti a pantografo

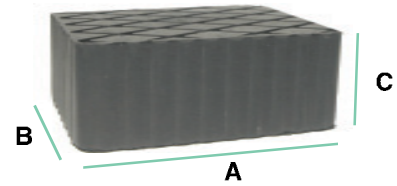

	A	B	C
520 600	mm 160	120	20
520 601	mm 160	120	30
520 602	mm 160	120	40
520 603	mm 160	120	60
520 604	mm 160	120	80
520 605	mm 160	120	120

Tampone “Long-Life” per ponte sollevamento

“Long-Life” rubber block for cars elevator

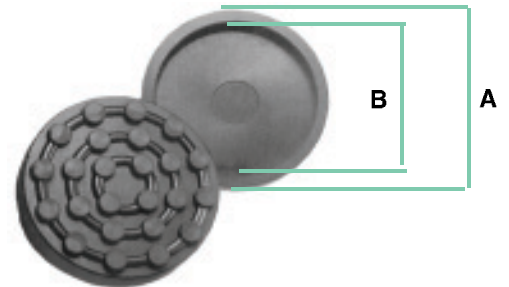

520 610 Ø esterno 120 (A) Ø interno 108 (B)

Riduzioni / Aumentatori da applicare ai pistoni dei pistoni crick da fossa utilizzabili con nostri articoli: 234 204 35 e 520 610 10



Riduzioni	A	B
234 204 22	Ø Est. 35	x pistoni Ø 22
234 204 25	Ø Est. 35	x pistoni Ø 25
234 204 30	Ø Est. 35	x pistoni Ø 30



Aumentatori	A	B
234 204 40	Ø Int. 45	x pistoni Ø 40
234 204 45	Ø Int. 45	x pistoni Ø 45

NOTE



Piattello in ferro con tampone "Long life" utilizzabile su crick da fossa con pistone Ø 35

Long life rubber block for crick

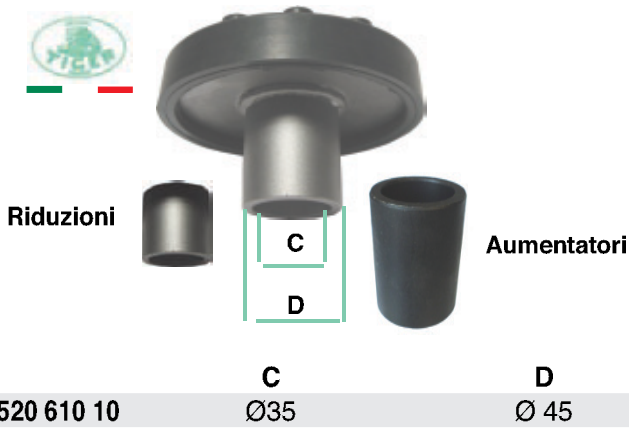

520 610 10 Ø35 Ø 45

Il piattello monta di serie un innesto per il pistone del crick di Ø35, mentre i per pistoni di Ø22, Ø25, Ø30, Ø40, Ø 45 come optional a richiesta sono disponibili 5 adattatori

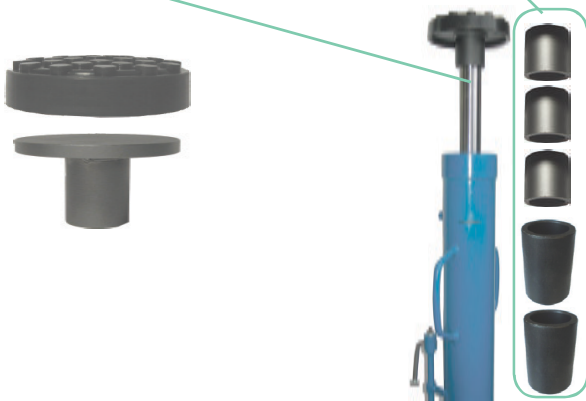

Tampone "Long-Life" per ponte sollevamento

"Long-Life" rubber block for cars elevator

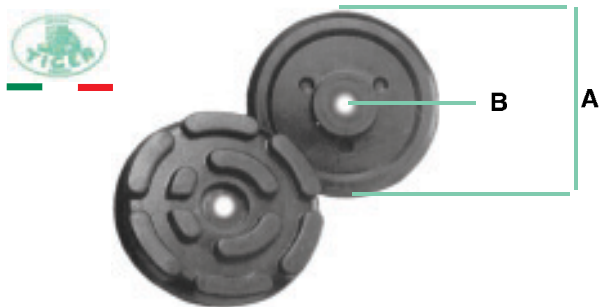

520 611 3 perni femmina Foro Ø12 (B)
Ø esterno 145 (A)

Tampone "Long-life" per ponte sollevamento

"Long-Life" rubber block for cars elevator



520 611 01 3 perni maschio esterno Ø 140 (A) Lunetta Ø 60 (B)

Tampone "Longlife" in gomma per ponte sollevamento

"Long-Life" rubber block for cars elevator



520 611 02 Ø esterno 144 (A) Lunetta Ø50 (B)

Tampone in gomma ideali per sollevatori idraulici

"Long-Life" rubber block for cars elevator



520 612 Ø esterno 160 (A) Ø interno 135 (B)

Tampone "Longlife" in gomma per ponte sollevamento

"Long-Life" rubber block for cars elevator



520 613 3 perni maschio / femmina Ø esterno (A) 145

520 617 3 perni maschio / femmina Ø esterno (A) 120

Tampone in gomma per ponte sollevamento

"Long-Life" rubber block for cars elevator



520 615 Ø esterno 100 (A) Ø interno 90 (B)

Tampone "Longlife" in gomma per ponte sollevamento

Rubber block



520 616 Ø esterno 125 (A) Ø interno 115 (B)

PER PONTI GERMANY

Tampone "Longlife" in gomma per ponte sollevamento

Rubber block



520 620 Ø esterno 145 (A) Ø interno 135 (B)

Tamponi in gomma rinforzati per furgoni

Rinforced rubber block for van

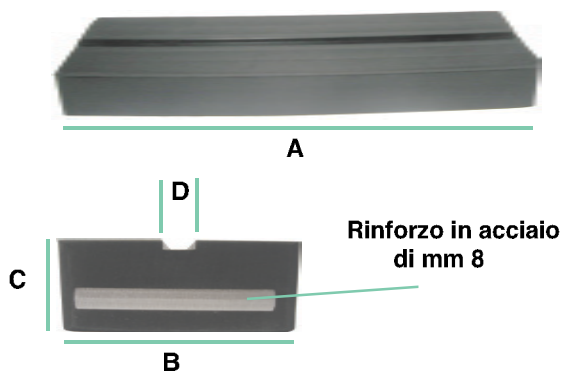

	A	B	C	D
520 640	185	100	35	11
520 641	370	100	35	11

ADATTI ANCHE PER PONTI A PANTOGRAFO

Tampone in gomma ideale per stazionamento Truck e utilizzabile anche su ponti a colonna

Rubber block

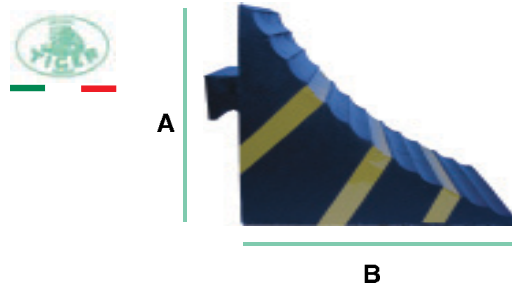

520 648 mm 190 (A) mm 250 (B)

Tampone in gomma vulcanizzata per stazionamento vetture

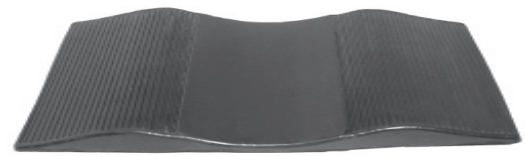

520 650 570x270x30 mm

Tampone in gomma ideale per stazionamento macchine ribassate



520 655 Altezza mm 80

NOTE



Rivetti in alluminio. Chiodo in acciaio zincato

Aluminium rivets. Steel nail



520 811	3 x 6 mm	1000 Pz
520 812	3 x 8 mm	1000 Pz
520 814	3 x 10 mm	1000 Pz
520 817	3 x 12 mm	1000 Pz
520 818	3 x 14 mm	1000 Pz
520 819	3 x 16 mm	1000 Pz
520 831	4 x 6 mm	1000 Pz
520 832	4 x 8 mm	1000 Pz
520 834	4 x 10 mm	1000 Pz
520 836	4 x 12 mm	1000 Pz
520 838	4 x 14 mm	1000 Pz
520 839	4 x 16 mm	500 Pz
520 840	4 x 18 mm	500 Pz
520 841	4 x 20 mm	500 Pz
520 851	4.8 x 7 mm	1000 Pz
520 852	4.8 x 8 mm	1000 Pz
520 853	4.8 x 9 mm	500 Pz
520 854	4.8 x 10 mm	500 Pz
520 856	4.8 x 12 mm	500 Pz
520 857	4.8 x 14 mm	500 Pz
520 858	4.8 x 16 mm	500 Pz
520 859	4.8 x 18 mm	500 Pz
520 860	4.8 x 20 mm	500 Pz
520 861	4.8 x 22 mm	500 Pz
520 861 01	4.8 x 25 mm	250Pz
520 870	6 x 15 mm	250 Pz
520 872	6 x 18 mm	250 pz
520 874	6 x 22 mm	250 Pz
520 876	6 x 26 mm	250 Pz
520 877	6 x 30 mm	250 Pz
520 878	6 x 35 mm	250 Pz
520 884	6.4 x 18 mm	250 Pz
520 885	6.4 x 22 mm	250 Pz
520 886	6.4 x 26 mm	250 Pz
520 887	6.4 x 30 mm	250 Pz
520 890	7.8 x 15 mm	250 Pz
520 891	7.8 x 18 mm	250 Pz
520 892	7.8 x 22 mm	250 Pz
520 893	7.8 x 26 mm	250 pz

Rivetti in rame

Rivets copper



520 901	1000 Pcs	3 mm	6 mm
520 902	1000 Pcs	3 mm	7 mm
520 903	1000 Pcs	3 mm	9 mm
520 904	1000 Pcs	3 mm	11 mm
520 906	1000 Pcs	3 mm	14 mm
520 921	1000 Pcs	3.4 mm	7 mm
520 922	1000 Pcs	3.4 mm	9 mm
520 923	1000 Pcs	3.4 mm	11 mm
520 925	1000 Pcs	3.4 mm	14 mm
520 931	1000 Pcs	3.8 mm	7 mm
520 932	1000 Pcs	3.8 mm	9 mm
520 933	1000 Pcs	3.8 mm	11 mm
520 935	1000 Pcs	3.8 mm	14 mm
520 936	500 Pcs	3.8 mm	16 mm

Rivetti in alluminio testa larga

Large head Aluminium rivets

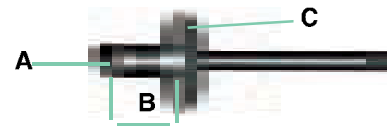

	A	B	C
520 951	Testa Ø12	4 x 12 mm	500 Pz
520 952	Testa Ø12	4 x 14 mm	500 Pz
520 953	Testa Ø12	4 x 16 mm	500 Pz
520 953 01	Testa Ø 12	4 x 18 mm	500 Pz
520 954	Testa Ø12	4 x 20 mm	500 Pz
520 955	Testa Ø12	4 x 24 mm	500 Pz
520 958	Testa Ø14	4.8 x 12 mm	500 Pz
520 959	Testa Ø14	4.8 x 14 mm	500 Pz
520 960	Testa Ø14	4.8 x 16 mm	250 Pz
520 961	Testa Ø14	4.8 x 18 mm	250 Pz
520 962	Testa Ø14	4.8 x 20 mm	250 Pz
520 963	Testa Ø14	4.8 x 22 mm	250 Pz
520 966	Testa Ø16	4.8 x 14 mm	250 Pz
520 967	Testa Ø16	4.8 x 16 mm	250 Pz
520 968	Testa Ø16	4.8 x 18 mm	250 Pz
520 969	Testa Ø16	4.8 x 20 mm	250 Pz

Rivettatrice a mano

Handle riveter lever type



521 101	Alu 2.4-3-3.2-4-4.8	Cu-Fe 3-3.2-4
---------	---------------------	---------------



www.afasupport.it

Rivettatrice a mano

Handle riveter lever type



521 102 Alu 2.4-3-3.2-4-4.8 Cu-Fe 3-3.2-4

Rivettatrice a mano

Handle riveter lever type



521 103 Alu 3-3.2-4-4.8-6-6.4 Cu-Fe 3-3.2-4-4.8-6

Rivettatrice a mano per lattoniere

Riveting tool



521 104 senza molla di ritorno Kg 0.540

- Rivetti in alluminio 2.4 - 3.0 - 3.2 - 4.0 - 4.8
- Rivetti in acciaio 3.0 - 3.2 - 4.0
- Rivetti in rame 3.0 - 3.2 - 4.0
- Rivetti INOX 3.0 - 3.2 - 4.0

Rivettatrice a mano con testa girevole

Handle riveter head joint

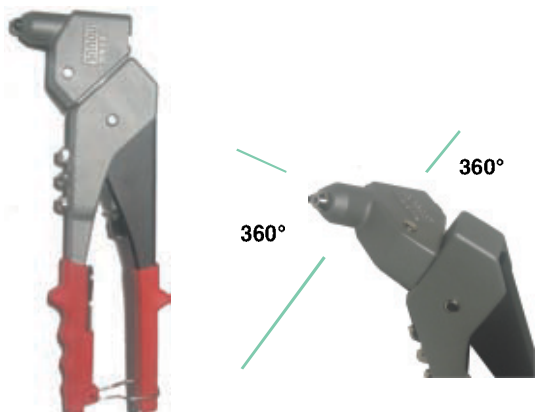

521 105 Alluminio: 2,4 - 3 - 4 - 5 Acciaio: 3 - 4 Rame: 4

Rivettatrice a mano 521 102 con 100 rivetti assortiti

Handle riveter 521 101with 100 miscellaneous rivets



521 110 Kit in valigetta

Rivettatrice a mano 521 101 con 100 rivetti assortiti

Handle riveter 521 101with 100 miscellaneous rivets



521 111 Kit in valigetta

Confezione contenente rivettatrice 521 102 con rivetti di alluminio assortiti dal Ø 3 al Ø 4.8

Box containing a rivetin tool



521 113 kit

Rivettatrice pneumatica

Pneumatic tool

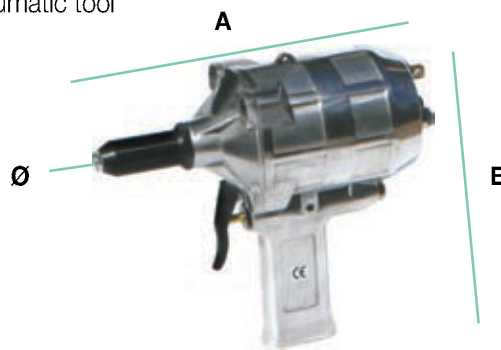

	A	B	Ø	KG
521 124	220	200	23	1,5

- Rivetti in alluminio 2,4 - 3 - 3,2 - 4.0 - 4,8
- Rivetti in acciaio 3 - 3.2 - 4.0
- Rivetti in rame 3 - 3.2 - 4.0
- Rivetti INOX 3 - 3.2 - 4.0

NOTE



Rivettatrice oleopneumatica con trattenuta del rivetto e recupero del chiodo tranciato

Hidropneumatic tool with holding of the rivet and nail recovery



521 128 DX 30

- Alluminio: Ø 4 - 4,8 - 5 - 6 - 6,4 - 7,8
- Acciaio: Ø 4 - 4,8 - 5 - 6 - 6,4
- Inox: Ø 4 - 4,8 - 5 - 6 - 6,4
- Unobolt: Ø 4,8 - 5 - 6,4

Dati tecnici - Informative

- Pressione aria: 5 - 7 Bar
- Volume d'aria per ciclo: 4,3 Lt
- Forza: 5 Bar
- Peso: 1,75 Kg

Set rivettatrice con rivetti in plastica

Plastic riveter set

Rivettatrice compatta a naso lungo, ideale per carrozzeria, paraurti, passaruote, targhe

Il kit è fornito di 40 rivetti delle misure più comuni:
Pz10: 5x15,8 - Pz10: 5x17,2
Pz10: 6,3x17,2 - Pz10: 6,6x17,2



521 150 1 rivettatrice + 40 rivetti

Ricambi - Spare parts

521 151	Rivettatrice	17x1	4
521 152	Rivetti in plastica	Ø 5 x 15,8	Pz10
521 153	Rivetti in plastica	Ø 5 x 17,2	Pz10
521 154	Rivetti in plastica	Ø 6,3 x 25,2	Pz10
521 155	Rivetti in plastica	Ø 6,6 x 17,2	Pz10

NOTE



Rivetti filettati a testa cilindrica in acciaio

Threaded insert countersunk head in steel

d ØH	D	B	S		$\frac{L}{T}$	L _i	L
mm	mm	mm	mm	mm	mm	mm	mm
M3	4,9	7	0,8	5	0,3-1,8	9,8-10,3	14,5
M4	5,9	9	1	6	0,3-2,5	11,3-12,0	16,5
M5	6,9	10	1,2	7	0,5-3,0	12,3-13,0	18
M6	8,9	12	1,5	9	0,5-2,3	14-14,5	20,5
M8	10,9	15	1,5	11	0,8-3,5	17,5-18,2	25,5
M10	11,9	16	1,7	12	1,0-3,5	21-22	29

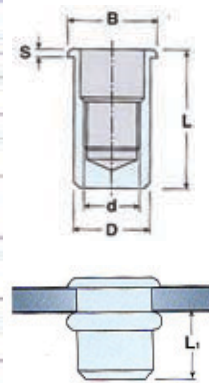

521 201	0,3-1,8	Singolo	M 3
521 202	0,3-2,5	Singolo	M 4
521 203	0,5-3	Singolo	M 5
521 204	0,5-2,3	Singolo	M 6
521 205	0,8-3,5	Singolo	M 8
521 206	1-3,5	Singolo	M10
521 201 01	0,3-1,8	Pz 200	M 3
521 202 01	0,3-2,5	Pz 200	M 4
521 203 01	0,5-3	Pz 200	M 5
521 204 01	0,5-2,3	Pz 200	M 6
521 205 01	0,8-3,5	Pz 200	M 8
521 206 01	1-3,5	Pz 200	M10

Rivetti filettati a testa cilindrica in lega di alluminio

Threaded insert countersunk head in aluminium

d ØH	D	B	S		$\frac{L}{T}$	L _i	L
mm	mm	mm	mm	mm	mm	mm	mm
M3	4,9	7	0,8	5	0,3-1,8	9,8-10,3	14,5
M4	5,9	9	1	6	0,3-2,5	11,3-12,0	16,5
M5	6,9	10	1,2	7	0,5-3,0	12,3-13,0	18
M6	8,9	12	1,5	9	0,5-2,3	14-14,5	20,5
M8	10,9	15	1,5	11	0,8-3,5	17,5-18,2	25,5
M10	11,9	16	1,7	12	1,0-3,5	21-22	29

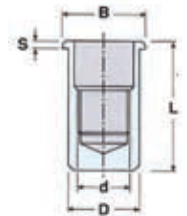

521 211	0,3-1,8	Singolo	M 3
521 212	0,3-2,5	Singolo	M 4
521 213	0,5-3	Singolo	M 5
521 214	0,5-2,3	Singolo	M 6
521 215	0,8-3,5	Singolo	M 8
521 216	1-3,5	Singolo	M10
521 211 01	0,3-1,8	Pz 200	M 3
521 212 01	0,3-2,5	Pz 200	M 4
521 213 01	0,5-3	Pz 200	M 5
521 214 01	0,5-2,3	Pz 200	M 6
521 215 01	0,8-3,5	Pz 200	M 8
521 216 01	1-3,5	Pz 200	M10

Inserti filettati a testa cilindrica in acciaio (C4C)

Threaded insert cylindrical head in steel

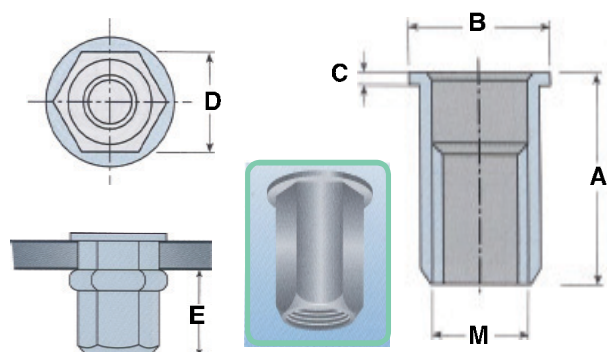

	M	A	B	C	D	E
521 304	M4	11	9	1	5,9	5,0 - 5,5
521 305	M5	14	10	1	6,9	7,2 - 7,7
521 306	M6	15	13	1,5	8,9	9,3 - 9,7
521 308	M8	18	16	1,5	10,9	10,8 - 11,5

Cassetta in plastica contenente rivettatrice per inserti filettati con tiranti e teste M3 - M4 - M5



Alluminio - Acciaio - Inox

521 402 Kg 0,91

Kit in cassetta di metallo contenente rivettatrice con tiranti e teste M3 - M4 - M5 e 300 inserti filettati assortiti (100 x)



Alluminio - Acciaio - Inox

521 403 Kg 3,00

Ricambi per NX 5 - NX 5 Spare parts

- 521 402 03 Tirante con testa M 3
- 521 402 04 Tirante con testa M 4
- 521 402 05 Tirante con testa M 5

Kit in busta di plastica contenente rivettatrice con tiranti e teste M3 - M4 - M5 - M6



Alluminio - Acciaio - Inox

521 404 Kg 0,950

Cassetta di metallo contenente rivettatrice con tiranti e teste M3 - M4 - M5 - M6 e 400 inserti filettati assortiti (100 x)



Alluminio - Acciaio - Inox

521 405 Kg 3,50

Ricambi per NX 55 - NX 55 Spare parts

- 521 404 03 Tirante con testa M 3
- 521 404 04 Tirante con testa M 4
- 521 404 05 Tirante con testa M 5
- 521 404 06 Tirante con testa M 6

Rivettatrice a mano per inserti filettati

Handle riveter for rivets with screw



521 408 M3-4-5-6-8-10 - Box metallico

Composizione - Composition

- | | | |
|------------|------------------|------|
| 521 408 03 | Tirante ricambio | M 3 |
| 521 408 04 | Tirante ricambio | M 4 |
| 521 408 05 | Tirante ricambio | M 5 |
| 521 408 06 | Tirante ricambio | M 6 |
| 521 408 08 | Tirante ricambio | M 8 |
| 521 408 10 | Tirante ricambio | M 10 |

Rivettatrice oleopneumatica per inserti filettati

Hydropneumatic tool for threaded rivets



521 409 10 rivettatrice

- Alluminio: M4 - M5 - M6 - M8 - M10 - M12
- Acciaio: M4 - M5 - M6 - M8 - M10 - M12
- Inox: M4 - M5 - M6 - M8 - M10 - M12

Assortimento rondelle in rame per iniettore spessore 1.5 mm

Copper ring set 1.5 mm



521 430 400 pcs assortiti RAME

Assortimento rondelle in alluminio spessore 1.5 mm

Aluminium ring set 1.5 mm



521 431 400 pcs assortiti ALLUMINIO

Assortimento rondelle in fibra spessore 1.5 mm

Fiber ring set 1.5 mm



521 432 400 pcs assortiti FIBRA

Assortimento O-Ring

Set O-Ring



521 433 Metreico 404 pcs
 521 434 Pollici 382 pcs
 521 435 HNBR per climatizzatori 240 pcs

O-Ring per climatizzatori in HNBR



521 436 Pz 360

Ricambi - Spare parts

521 436 04	Rif. 502 1004	Pz 25
521 436 13	Rif. 502 1013	Pz 25
521 436 14	Rif. 502 1014	Pz 25
521 436 20	Rif. 502 1020	Pz 25
521 436 21	Rif. 502 1021	Pz 25
521 436 22	Rif. 502 1022	Pz 25
521 436 23	Rif. 502 1023	Pz 25
521 436 24	Rif. 502 1024	Pz 25
521 436 25	Rif. 502 1025	Pz 25
521 436 26	Rif. 502 1026	Pz 25
521 436 27	Rif. 502 1027	Pz 25
521 436 31	Rif. 502 1031	Pz 25
521 436 32	Rif. 502 1032	Pz 25
521 436 33	Rif. 502 1033	Pz 25
521 436 39	Rif. 502 1039	Pz 25
521 436 49	Rif. 502 1049	Pz 25
521 436 50	Rif. 502 1050	Pz 25
521 436 57	Rif. 502 1057	Pz 25
521 436 58	Rif. 502 1058	Pz 25
521 436 59	Rif. 502 1059	Pz 25
521 436 60	Rif. 502 1060	Pz 25
521 436 62	Rif. 502 1062	Pz 25
521 436 66	Rif. 502 1066	Pz 25
521 436 70	Rif. 502 1070	Pz 25
521 436 71	Rif. 502 1071	Pz 25

Kit O-Ring per climatizzatori



521 436 00 In valigetta Pz 270

Composizione - Composition

4.47 x 1.78 - 5.28 x 1.78 - 6.07 x 1.78 - 7.65 x 1.78 - 9.25 x 1.78 -
 10.82 x 1.78 - 17.17 x 1.78 - 6.8 x 1.9 - 8.8 x 1.9 - 8 x 2 - 12 x 2 -
 13 x 2 - 14 x 2 - 15 x 2 - 10.77 x 2.62 - 13.95 x 2.62 - 15.54 x 2.62 -
 20.22 x 3.53

Kit guarnizioni O-ring speciali per climatizzatori

Special O-ring set



521 437 Pz 51

Ricambi - Spare parts

521 437 73	O-Ring clima doppi per Fiat	Ø 11
521 437 74	O-Ring clima doppi per Fiat	Ø 16
521 437 75	O.Ring clima doppi per Fiat	Ø 19
521 437 76	Guarnizione speciale clima per Peugeot	Ø 12
521 437 77	Guarnizione speciale clima per Peugeot	Ø 15
521 437 78	Guarnizione speciale clima per Renault	Ø 14,5
521 437 79	Guarnizione speciale clima per Peugeot	Ø 18
521 437 80	Guarnizione speciale clima per Peugeot	Ø 22
521 437 81	Guarn. spec. clima universale con esagono	Ø 8
521 437 82	Guarn. spec. clima universale con esagono	Ø 11
521 437 83	Guarn. spec. clima universale con esagono	Ø 14
521 437 84	Guarn. spec. clima universale con esagono	Ø 18

Rondelle di tenuta in rame spessore mm 1

Cooper ring mm1



A x B		A x B	
521 438	mm 6 x 10 x 1	521 438 06	mm 9 x 15 x 1
521 438 02	mm 6 x 12 x 1	521 438 09	mm 11 x 16 x 1
521 438 03	mm 8 x 12 x 1		



Rondelle di tenuta in rame, spessore mm 1,5

Copper ring 1.5 mm

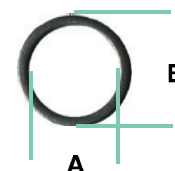

A x B		
521 440	mm 6 x 12 x 1,5	vendute singolarmente
521 441	mm 8 x 12 x 1,5	vendute singolarmente
521 442	mm 8 x 14 x 1,5	vendute singolarmente
521 442 00	mm 8 x 16 x 1,5	vendute singolarmente
521 442 01	mm 9 x 13 x 2	vendute singolarmente
521 442 02	mm 10 x 20 x 1,5	vendute singolarmente
521 442 03	mm 10 x 14 x 1,5	vendute singolarmente
521 442 04	mm 10 x 16 x 1,5	vendute singolarmente
521 442 05	mm 12 x 16 x 1,5	vendute singolarmente
521 443	mm 12 x 18 x 1,5	vendute singolarmente
521 443 00	mm 13 x 17 x 1,5	vendute singolarmente
521 443 01	mm 13,5 x 19 x 1,5	vendute singolarmente
521 443 02	mm 14 x 18 x 1,5	vendute singolarmente
521 444	mm 14 x 20 x 1,5	vendute singolarmente
521 444 00	mm 15 x 19 x 1,5	vendute singolarmente
521 444 01	mm 16 x 20 x 1,5	vendute singolarmente
521 445	mm 16 x 22 x 1,5	vendute singolarmente
521 445 00	mm 17 x 22 x 1,5	vendute singolarmente
521 445 01	mm 18 x 22 x 1,5	vendute singolarmente
521 446	mm 18 x 24 x 1,5	vendute singolarmente
521 446 01	mm 18 x 26 x 1,5	vendute singolarmente
521 447	mm 20 x 26 x 1,5	vendute singolarmente
521 447 01	mm 20 x 28 x 1,5	vendute singolarmente
521 448	mm 22 x 28 x 1,5	vendute singolarmente
521 448 01	mm 24 x 30 x 1,5	vendute singolarmente
521 448 02	mm 26,5 x 32 x 1,5	vendute singolarmente
521 449	mm 32 x 38 x 1,5	vendute singolarmente

Assortimento rondelle toroidali

Ring set



521 450 In valigetta - Pz 180

Composizione - Composition

521 452	10 x 16 x 2,5	Pz 30
521 453	12 x 18 x 2,5	Pz 30
521 454	14 x 20 x 2,5	Pz 40
521 455	16 x 22 x 2,5	Pz 40
521 456	18 x 24 x 2,5	Pz 20
521 457	20 x 26 x 2,5	Pz 20

Rondelle in rame toroidali

Spare rings

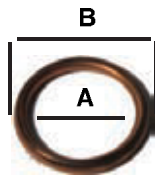

A x B

521 452	10 x 16 x 2,5	Venduta singola
521 453	12 x 18 x 2,5	Venduta singola
521 454	14 x 20 x 2,5	Venduta singola
521 455	16 x 22 x 2,5	Venduta singola
521 456	18 x 24 x 2,5	Venduta singola
521 457	20 x 26 x 2,5	Venduta singola
521 457 01	22 x 28 x 2,5	Venduta singola
521 458	26 x 32 x 2,5	Venduta singola

Rondelle in alluminio spessore mm 1,5

Aluminium ring mm 1,5



A x B

A x B

521 460 02	6 x 10 x 1.5	521 460 25	16 x 20 x 1.5
521 460 04	6 x 12 x 1.5	521 460 26	16 x 22 x 1.5
521 460 06	8 x 12 x 1.5	521 460 29	18 x 22 x 1.5
521 460 08	8 x 14 x 1.5	521 460 30	18 x 24 x 1.5
521 460 11	10 x 14 x 1.5	521 460 32	20 x 26 x 1.5
521 460 13	10 x 16 x 1.5	521 460 35	21.5 x 26 x 1.5
521 460 15	12 x 16 x 1.5	521 460 38	22 x 28 x 1.5
521 460 16	12 x 18 x 1.5	521 460 40	24 x 30 x 1.5
521 460 21	14 x 18 x 1.5	521 460 41	26.5 x 32 x 1.5
521 460 23	14 x 20 x 1.5	521 460 43	28 x 34 x 1.5
		521 460 44	30 x 36 x 1.5

Anello di tenuta in metallo + gomma per viti

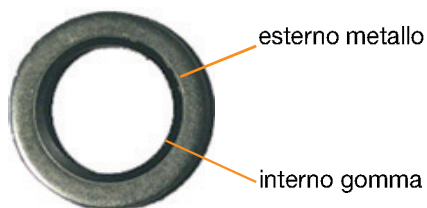

521 465 06	M 6	521 465 14	M 14
521 465 08	M 8	521 465 16	M 16
521 465 10	M 10	521 465 18	M 18
521 465 12	M 12 - 13	521 465 26	M 26

Pinza tirafascette in nylon professionale

Band Plier



521 470

Pistola tirafascette in nylon in materiale plastico

Band Plier



521 472

Fascette di cablaggio autoestinguenti

Electric band



521 481	100 pcs	2,5x102 mm
521 482	100 pcs	2,5x140 mm
521 483	100 pcs	2,5x202 mm
521 490	100 pcs	3,6x140 mm
521 491	100 pcs	3,6x202 mm
521 492	100 pcs	3,6x290 mm
521 495	100 pcs	4,8x160 mm
521 496	100 pcs	4,8x200 mm
521 497	100 pcs	4,8x286 mm
521 498	100 pcs	4,8x360 mm
521 499	100 pcs	7,6x368 mm
521 500	100 pcs	7,6x450 mm

Fascette di cablaggio BAND - IT-TIE-LOK®

BAND - IT-TIE- LOK®



521 501	6.3x254 mm	521 504	6.3x757 mm
521 502	6.3x419 mm	521 505	6.3x889 mm
521 503	6.3x572 mm		

Pinza per fascette tipo Panduit per applicazione cuffie su giunti omocinetic. Serraggio e taglio automatico



521 514

Pinza per fascette giunti omocinetici con leva tagliafascetta



521 515

Ricambi - Spare parts

521 515 01	MG-37	521 515 03	SD-08
521 515 02	MG-39		

Fascette INOX per giunti omocinetici da utilizzare

con pinza 521 515 - 521 514

521 514



521 515



521 516 01	Pz 100	4,6 x 201
521 516 02	Pz 100	4,6 x 360
521 516 03	Pz 100	4,6 x 520
521 518 01	Pz 100	7,9 x 201
521 518 02	Pz 100	7,9 x 362
521 518 03	Pz 100	7,9 x 520

Pinza originale BAND - IT-TIE-LOK®

Original plier BAND - IT-TIE LOK®



521 520 M 3-4-5-6

Fascette di cablaggio PANDUIT®

Electric band PANDUIT®



521 521	Vendute singole	4.6 x 201
521 521 01	New - Vendute singole	4.6 x 259
521 523	Vendute singole	4.6 x 360
521 524	Vendute singole	4.6 x 520
521 531	Vendute singole	7.9 x 201
521 533	Vendute singole	7.9 x 360
521 534	Vendute singole	7.9 x 520

Fascette Panduit per giunti

Con recupero di chiusura "Superior Grip"



Dopo il montaggio la molla si contrae per una presa superiore

Durante il montaggio la molla si allunga



Fascette Panduit per giunti omocinetici con recupero di chiusura, per eliminare il gioco della sfera di tenuta che si crea dopo il montaggio sulla cuffia in gomma, questo sistema permette anche il recupero del gioco che si crea con l'assottigliarsi dello spessore della cuffia parapolvere in gomma

521 538	mm 7.9 x 360	Ø max 102
521 539	mm 7.9 x 520	Ø max 152

Fascette inox per cuffie giunti omocinetici



521 543	Ø 72 - 80	521 547	Ø 96 - 104
521 544	Ø 78 - 86	521 548	Ø 102 - 110
521 545	Ø 84 - 92	521 549	Ø 108 - 116
521 546	Ø 90 - 98	521 549 01	Ø 114 - 122

Fascette a due orecchie pinzabili in acciaio galvanizzato zincato

Steel band



521 550	Ø 5 - 7	521 558	Ø 17 - 20
521 551	Ø 7 - 9	521 559	Ø 18 - 21
521 552	Ø 9 - 11	521 560	Ø 20 - 23
521 554	Ø 11 - 13	521 561	Ø 22 - 25
521 555	Ø 13 - 15	521 562	Ø 23 - 27
521 556	Ø 14 - 17	521 563	Ø 25 - 28
521 557	Ø 15 - 18	521 564	Ø 28 - 31

Kit fascette a due orecchie pinzabili

Set steelband



521 565	da 5-7 a 20-23	10 per misura	110 Pz
---------	----------------	---------------	--------

Fascetta Meb con anello a cremagliera stampata in acciaio AISI 430

Hoses band steel AISI 430

Cassetto in acciaio al carbonio nikelato



Vite in Acciaio zincato

521 610	Banda mm 5	Ø 7 - 11
521 610 01	Confezione 100 Pz	

Fascette con anello a cremagliera e bordi arrotondati e rialzati a protezione del tubo

Hoses band steel



521 610 04	New	mm 8 - 12	Singola
521 610 05	New	mm 8 - 12	Confezione Pz 100
521 610 07	New	mm 8 - 14	Singola
521 610 08	New	mm 8 - 14	Confezione Pz 100

Fascette Meb 9 TOP Q con anello a cremagliera stampata in acciaio AISI 430

Cassetto in acciaio al carbonio nikelato



Vite in Acciaio zincato

Bordi arrotondati e rialzati a protezione del tubo. Cassetto maggiorato per presa della vite su più filetti con conseguente maggiore serraggio. Utilizzo anche industriale

COPPIA SERRAGGIO NM 5

521 611	Banda mm 9	Ø 8 - 16	Singola
521 611 01	Confezione 100 Pz		
521 612	Banda mm 9	Ø 10 - 17	Singola
521 612 01	Confezione 100 Pz.		
521 613	Banda mm 9	Ø 12 - 20	Singola
521 613 01	Confezione 100 Pz.		
521 614	Banda mm 9	Ø 15 - 25	Singola
521 614 01	Confezione 100 Pz.		
521 615	Banda mm 9	Ø 20 - 32	Singola
521 615 01	Confezione 100 Pz.		
521 616	Banda mm 9	Ø 25 - 40	Singola
521 616 01	Confezione 100 Pz.		
521 617	Banda mm 9	Ø 32 - 50	Singola
521 617 01	Confezione 100 Pz.		
521 618	Banda mm 9	Ø 40 - 60	Singola
521 618 01	Confezione 100 PZ.		
521 619	Banda mm 9	Ø 50 - 70	Singola
521 619 01	Confezione 100 Pz.		
521 620	Banda mm 9	Ø 60 - 80	Singola
521 620 01	Confezione 100 Pz.		

Kit fascette inox TOP con chiave a bussola flessibile

OKit hoses band steel with flexible hand socket



521 625	In valigetta	Pz 191
---------	--------------	--------

Composizione - Composition

415 0705	Chiave a bussola flessibile mm 7 (pz 1)
521 610 01	Fascetta inox banda mm 5 - Ø 7 x 11 (pz 20)
521 610 04	Fascetta inox banda mm 5 - Ø 8 x 12 (pz 20)
521 610 07	Fascetta inox banda mm 5 - Ø 8 x 14 (pz 20)
521 611	Fascetta inox banda mm 9 - Ø 8 x 16 (pz 20)
521 612	Fascetta inox banda mm 9 - Ø 10 x 17 (pz 30)
521 613	Fascetta inox banda mm 9 - Ø 12 x 20 (pz 30)
521 614	Fascetta inox banda mm 9 - Ø 15 x 25 (pz 10)
521 615	Fascetta inox banda mm 9 - Ø 20 x 32 (pz 20)
521 616	Fascetta inox banda mm 9 - Ø 25 x 40 (pz 20)

Fascette Meb 12 con anello a cremagliera stampata in acciaio AISI 304.

Cassetto in acciaio al carbonio nikelato



Vite in Acciaio zincato

Bordi arrotondati e rialzati a protezione del tubo

COPPIA SERRAGGIO NM 8

521 631	Banda mm 12	Ø 25 - 40
521 632	Banda mm 12	Ø 25 - 45
521 633	Banda mm 12	Ø 32 - 50
521 634	Banda mm 12	Ø 40 - 60
521 635	Banda mm 12	Ø 50 - 70
521 636	Banda mm 12	Ø 60 - 80
521 637	Banda mm 12	Ø 80 - 100
521 638	Banda mm 12	Ø 90 - 110
521 639	Banda mm 12	Ø 100 - 120
521 640	Banda mm 12	Ø 110 - 130
521 641	Banda mm 12	Ø 120 - 140
521 642	Banda mm 12	Ø 135 - 165
521 643	Banda mm 12	Ø 160 - 180

Fascetta stringitubo GEM1 in acciaio inox Aisi 430 banda mm 12-spessore mm 0.7 calottina in inox Aisi 430 - Vite in C22 zincata - Coppia Ser. Nm 5



521 650 10	BP12	Ø 100 -120
521 650 11	BP12	Ø 110 -130
521 650 12	BP12	Ø 120 -140
521 650 13	BP12	Ø 130 -150
521 650 14	BP12	Ø 140 -160
521 650 16	BP12	Ø 160 -180
521 650 18	BP12	Ø 180 -200

Fascette stringitubo a collare

Hoses band with nut



521 651	diam. 5-9 mm	521 653	diam. 9-14 mm
521 652	diam. 7-12 mm		

Fascetta a cavalletto zincata

Clamp



521 671	Diam. 38 mm	521 676	Diam. 51 mm
521 673	Diam. 43 mm	521 677	Diam. 54 mm
521 674	Diam. 45 mm	521 679	Diam. 60 mm
521 675	Diam. 48 mm	521 680	Diam. 63 mm

Pinze per collari giunzione tubi scarico



521 685

Morsetto a cavalletto per funi, zincato

Clamp

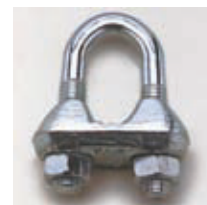

521 691	Fune 3-4 mm	Diam. 3/16"
521 692	Fune 5-6 mm	Diam. 1/4"
521 693	Fune 7-8 mm	Diam. 5/16"
521 694	Fune 7-10 mm	Diam. 3/8"
521 695	Fune 12 mm	Diam. 1/2"
521 696	Fune 13-14 mm	Diam. 9/16"
521 697	Fune 15-16 mm	Diam. 5/8"
521 698	Fune 19-20 mm	Diam. 3/4"
521 699	Fune 22 mm	Diam. 7/8"
521 700	Fune 24 mm	Diam. 1"

Grillo in ferro zincato diritto

Clamp U type



521 701	Diam. 5/16"	521 705	Diam. 5/8"
521 702	Diam. 3/8"	521 706	Diam. 3/4"
521 703	Diam. 1/2"	521 707	Diam. 7/8"
521 704	Diam. 9/16"	521 708	Diam. 1"

Golfare maschio in ferro forgiato

Drop forged steel eyebolt



521 711	6 MA	521 716	16 MA
521 712	8 MA	521 717	18 MA
521 713	10 MA	521 718	20 MA
521 714	12 MA	521 719	22 MA
521 715	14 MA	521 720	24 MA

Golfare femmina in ferro forgiato

Drop forged steel eyebolt



521 721	6 MA	521 726	16 MA
521 722	8 MA	521 727	18 MA
521 723	10 MA	521 728	20 MA
521 724	12 MA	521 729	22 MA
521 725	14 MA	521 730	24 MA

Redance ovali in ferro zincato per funi metalliche e corde canapa

Ring eye on steel



521 731	Diam. 3 mm	521 737	Diam. 12 mm
521 732	Diam. 4 mm	521 738	Diam. 14 mm
521 733	Diam. 5 mm	521 739	Diam. 16 mm
521 734	Diam. 6 mm	521 740	Diam. 18 mm
521 735	Diam. 8 mm	521 741	Diam. 20 mm
521 736	Diam. 10 mm		

Tenditore a due occhi in ferro stampato zincato

Tender

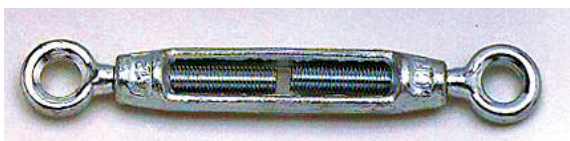

521 751	Diam. 1/4"	521 756	Diam. 5/8"
521 752	Diam. 5/16"	521 757	Diam. 3/4"
521 753	Diam. 3/8"	521 758	Diam. 7/8"
521 754	Diam. 1/2"	521 759	Diam. 1"
521 755	Diam. 9/16"		

Morsetto a mano

Hand vice



521 772	120 mm	521 775	180 mm
521 774	160 mm		

Morsetto pesante forgiato verniciato

Clamp



521 781	75 mm	521 784	200 mm
521 782	100 mm	521 785	250 mm
521 783	150 mm	521 786	300 mm

Morsetto falegname in acciaio verniciato

Quick release bar clamp



521 801	25x6 mm	h 80 mm	150 mm
521 802	25x6 mm	h 80 mm	200 mm
521 803	25x6 mm	h 80 mm	250 mm
521 804	25x6 mm	h 80 mm	300 mm
521 805	30x6 mm	h 90 mm	350 mm
521 806	30x6 mm	h 90 mm	400 mm
521 807	35x7 mm	h 100 mm	500 mm
521 808	35x7 mm	h 100 mm	600 mm
521 809	35x7 mm	h 100 mm	700 mm
521 810	35x7 mm	h 100 mm	800 mm
521 811	40x7 mm	h 110 mm	1000 mm
521 812	40x7 mm	h 110 mm	1200 mm
521 813	40x7 mm	h 110 mm	1500 mm
521 814	40x8 mm	h 110 mm	1800 mm
521 815	40x8 mm	h 110 mm	2000 mm
521 816	40x8 mm	h 110 mm	2500 mm
521 817	40x8 mm	h 110 mm	3000 mm

Morsetto a Crick in acciaio temprato per meccanica

General use steel clamps ratchet

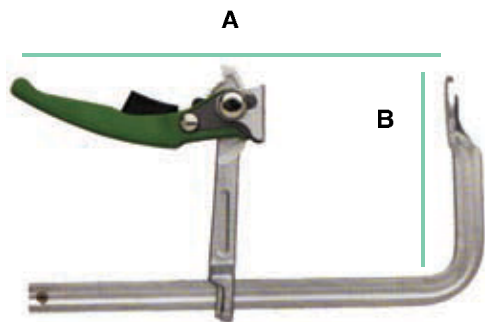

	A	B	Kg
521 822	mm 250	mm 120	1,46
521 823	mm 300	mm 140	2,42
521 824	mm 400	mm 120	2,55
521 825	mm 500	mm 120	2,76
521 826	mm 600	mm 120	2,97

Ricambi - Spare parts



- 521 822 01 Ricambio x mm 250
- 521 823 01 Ricambio x mm 300
- 521 824 01 Ricambio x mm 400 - 500 - 600

Morsetto rapido

Hand clamp



521 850	mm 150	521 852	mm 455
521 851	mm 300	521 853	mm 610

Dati tecnici - Informative

Impugnatura rivestita in gomma antiscivolo
 Tampone rigato per un maggiore Grip durante il serraggio
 Asta in acciaio trafilato "I Beam"
 Ganasce rovesciabili per poterlo utilizzare come allargatore
 Sistema di bloccaggio a doppia molla, questo sistema aumenta del 40% la forza di serraggio e la capacità di tenuta

Morsetto azionabile con una sola mano, leva di sgancio rapido e molla rinforzata per aumentare la presa. Manici ergonomici antiscivolo

Hand clamp

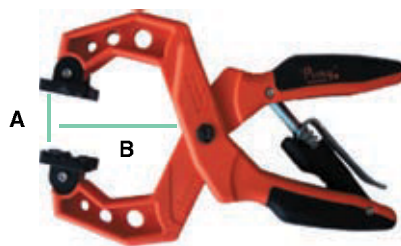

	A	B
521 860	mm 38	mm 40
521 861	mm 57	mm 60
521 862	mm 101	mm 90

Lucchetto in ottone con perni in acciaio tipo pesante

Solid brass padlock with hardened steel pins



521 901	20 mm	521 904	40 mm
521 902	25 mm	521 905	50 mm
521 903	30 mm	521 906	60 mm

Lucchetto in ottone con perni in acciaio tipo leggero

Solid brass padlock with hardened steel pins



521 911	20 mm	521 914	40 mm
521 912	25 mm	521 915	50 mm
521 913	30 mm	521 916	60 mm

Lucchetto in ottone con perni in acciaio tipo lungo

Solid brass padlock with hardened steel pins



521 921	40 mm
---------	-------

Sistema di sicurezza per vano carico

“NOVITÀ ASSOLUTA”



Ultra rinforzato



Comodissimo da usare

- 521 922 Venduto singolo
- 521 923 Venduto in coppia

Dati tecnici - Informative

Non un semplice lucchetto ma un sistema di sicurezza rinforzato facile da montare e usare, infatti rimane applicato al furgone e si chiude automaticamente alla chiusura della porta lasciando all'operatore le mani libere. Non afferrabile con utensili da scasso e resistente a qualsiasi utensile da taglio. Massima protezione per la merce che trasporti e massima comodità in apertura e chiusura. Apertura di sicurezza interna tramite filo di acciaio. 3 chiavi di scorta più un codice a barre su scheda nel caso di smarrimento.

Bloccasterzo con barra scorrevole registrabile

Steering wheel lock



- 521 925 Bloccasterzo

Blocca freni a disco

Brake wheel lock



- 521 926 perno diam. 5.5 mm
- 521 927 perno diam. 10 mm

Sistema di ancoraggio con nastro 25 mm e fibbie di arresto a molla carico 500 Kg

25 mm bend for fasten with release closing



- 521 931 2 pcs x 2,5 mt
- 521 932 2 pcs x 3 mt
- 521 933 2 pcs x 4 mt
- 521 934 2 pcs x 5 mt

Sistema di ancoraggio con 2 nastri da 2 mt. 25 mm con cricchetto tenditore e ganci metallici di arresto carico 1000 kg

25 mm bend for fasten with release closing



- 521 935 2pcs x 2 mt.

Sistema di ancoraggio con due nastri da 2 mt. 25 mm con ganci metallici e meccanismi di bloccaggio, carico 650 Kg

25 mm bend for fasten with release closing



- 521 936 2 pcs x 2 mt

Sistema di ancoraggio multiuso con cricchetto tenditore



- 521 936 10 Nastro mt. 4x25mm Resistenza Kg. 1.000
- 521 936 11 Nastro mt. 5x30mm Resistenza Kg. 1.300

Sistema di traino con nastro 25 mm e fibbie di arresto, regolazione ad asola carico 2000 Kg

25 mm bend for tow cars



- 521 937 3.5 mt

Valigetta di servizio con guanti, nastro traino, cinghie di ancoraggio e tanichetta

Multiservice bag with gloves fuel tank and tow



521 940 Kit in valigetta

Composizione - Composition

- 513 971 guanti
- 521 937 traino
- 521 931 cinghie ancoraggio tanichetta

Trianti in poliestere nastro a doppio strato CEN 118 EN 1492-1, coefficiente sicurezza 1:7

Strap in polyester ribbon to double layer CEN 118 ENs 1492-1, coefficient safety 1:7



Carico in %



Colore	VIOLA	VERDE	GIALLO	GRIGIO
Portata	1T	2T	3T	4T
Largh.	50	60	90	120
Metri 1	521 941 01	521 941 11	521 941 21	85
Metri 2	521 941 02	521 941 12	521 941 22	521 941 32
Metri 3	521 941 03	521 941 13	521 941 23	521 941 33
Metri 4	521 941 04	521 941 14	521 941 24	521 941 34
Metri 5			521 941 25	521 941 35

NOTE



Fune tonda ad anello continuo in poliestere CEN 118 EN 1492-2, coefficiente sicurezza 1:7

Round rope to continuous ring CEN 118 ENs 1492-2, coefficient safety 1:7



Carico in %



Colore	VIOLA	VERDE	GIALLO	GRIGIO
Portata	1T	2T	3T	4T
Diam.	48.5	58.8	66.8	68.8
Metri 2	521 942 01	521 942 11	521 942 21	
Metri 3	521 942 02	521 942 12	521 942 22	521 942 32
Metri 4	521 942 03	521 942 13	521 942 23	521 942 33
Metri 5	521 942 04	521 942 14	521 942 24	521 942 34
Metri 6	521 942 05	521 942 15	521 942 25	521 942 35

Sistema di ancoraggio TMU 2 500 daN carico rottura 7500Kg

System of anchorage TMU 2 500 daNs loaded breakup 7500Kg



521 943 01 Gancio a 2 dita - fascia mm 50x 8 mt Port. 2500 Kg

Sistema di ancoraggio TMU 2 500 daN carico rottura 7500Kg

System of anchorage TMU 2 500 daNs loaded breakup 7500Kg



521 943 02 Gancio a uncino - fascia mm 50x 8 mt Port. 2500 Kg

Fune speciale per sollevamento bidoni

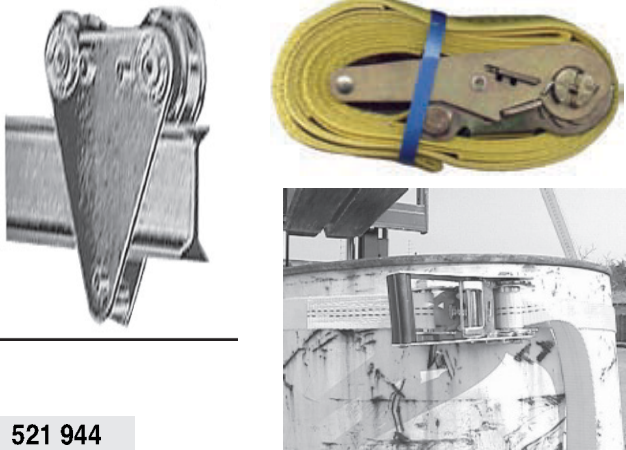

521 944

Spatola per vetri auto

Car glass cleaner



521 947

Pistola colla a caldo senza fili

Hot-melt glue applicator



521 948 Gluematic 5000

Composizione - Composition

Pistola con basetta
2 ugelli (corto e lungo)
5 colle trasparenti

Dati tecnici - Informative

Potenza di fusione elevatissima, lavorazione senza fili, stazione di caricamento con vaschetta salva-gocce, ugelli sostituibili, dispositivo di avanzamento stick meccanico per un'incollaggio rapido, ben dosato e senza sprechi.

Allacciamento alla rete: 220 - 240 V

Potenza in fase di riscaldamento: ca. 500W

Potenza in fase di riposo: ca. 20W

Potenza in fase di lavoro: ca. 120W

Tempo di accumolo calore: 3 - 5 min

Temperatura di fusione: 210 - 220°

Stick di adesivo: Ø mm 11

Accessori: 2 ugelli intercambiabili

Peso: 330 gr. (senza cavalletto)

Pistola per cartucce di adesivo al silicone

Glue gun

STEINEL



521 949 STEINEL 3002 - 45 Watt

Ugelli di ricambio per pistola termica 521 949

Exchange for 521 949



521 949 01 Ugello corto

521 949 02 Ugello lungo

Stick colla Ø 11 per pistole colla a caldo

Hot-melt glue applicator



521 950 10 Colla trasparente Kg 1

521 950 11 Colla bianca Kg 1

521 950 12 Colla gialla Kg 1

521 950 13 Colla rossa Kg 1

521 950 14 Colla nera Kg 1

521 950 15 Colla trasparente Kg 5

521 950 16 Colla bianca Kg 5

521 950 17 Colla gialla Kg 5

521 950 18 Colla rossa Kg 5

521 950 19 Colla nera Kg 5

521 952 Colla nera Pz 10 Kg 0,2

521 952 10 Colla trasparente Pz 10 Kg 0,2

Pistola per silicone

Silicon applicator

521 953



Pistola per silicone professionale

Professional silicon gun



521 954

Pistola per tasselli chimici

Gun for chemical inserts



521 960 380 MI

Pistola per schiuma poliuretanic

Gun for poliuretanic foam



521 965 380 MI

Pulizia pistola tramite bombola di lavaggio

NOTE



Cavalletto rotativo sostegno motori. Colonna con quadro sez. mm 70



Max 120



522 001 1 Colonna Base appoggio ferro a "U" mm 50x25 cm 61x64

522 002 2 Colonne Telescopico 120 cm. Max 8 piedini gomma di appoggio

Colonna sostegno vettura e furgone

Stand for holding car and vans



522 011 300-450 mm 522 012 400-650 mm



www.afasupport.it

Carrello idraulico spostamento vetture

Auto position Jack



522 013 Portata 600 Kg

Dati tecnici - Informative

Lunghezza mm 640 - Larghezza mm 550 - altezza mm 185 Ruote in Nylon.

Per manovrare e posizionare ogni tipo di vettura in spazi ristretti, particolarmente indicato per carrozzerie, saloni d'auto, officine di riparazione e garages.

Coppia cavalletti sostegno vetture e autocarri

Couple jack stand



522 014 Portata 3 Ton Alzata min 300 - max 430 mm

522 014 01 Portata 6 Ton Alzata min 400 - max 610 mm

Colonnette con prolungamento a vite con cuscinetto reggispinta per auto e autocarro

Supporting stand for car and trucks



522 015 500-750 mm 15 Ton. 30 Kg

522 016 690-1000 mm 15 Ton. 48 Kg

Colonnette con prolungamento a spina autocarro

Supporting stand for trucks



522 017 430-670 mm 15 Ton. 30 Kg

522 018 690-1160 mm 15 Ton. 41 Kg

Letino sottovettura in plastica 6 ruote

Under car Creeper



522 019 Kg 6,5

522 019 01 Ruota di ricambio (vendute singolarmente)

522 019 02 Set 12 viti di ricambio

Sgabello a 4 ruote con vaschetta

SCHOP SEAT



522 020

NOTE



Comodi tappeto sottovettura e mini-tappeto

Professional under car carpet

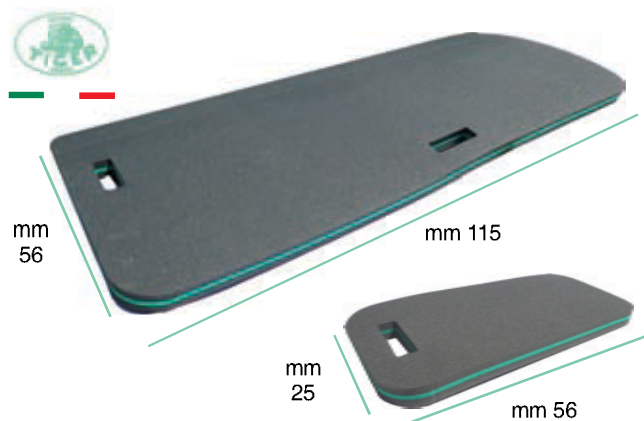

522 021 02 Confezione composta da 1 tappeto e 1 mini-tappeto in scatola

522 021 04 Confezione composta da 2 tappeti e 2 mini-tappeti in scatola

Dati tecnici - Informativa

Utilizzabili come lettino, sedile o inginocchiatoio, in materiale di polietilene reticolato espanso a cellula chiusa, ottima resistenza all'olio e alla benzina, leggero morbido e facilmente trasportabile grazie alle loro pratiche maniglie.

Lettino sottovettura in gomma 6 ruote

Rubber under Car-creeper



522 021 10 Carrello

522 021 11 Accessorio vaschetta (non incluso)

522 021 12 Ruote di ricambio

Lettino sottovettura pesante in lamiera di ferro poggiatesta imbottito

Creeper



522 022 colore grigio

Carrello portaattrezzi a tre piani con due ruote fisse e due girevoli diametro 60 mm

Weeled trucks for tools with three floors



522 025 615x440x780h - colore grigio

Carrello porta attrezzi in lamiera pesante a tre piani con due ruote fisse e due girevoli diametro 80 mm

Weeled trucks for tools with three floors



522 026 810x460x800h - colore grigio

Carrello porta attrezzi pesante saldato, 3 vasche rinforzate, ruote Ø125 2 fisse e 2 piroettanti, portata 120 Kg per piano. Colore RAL 5015-BLU

Cart brings utensils heavy settled, 3 strengthened tubs, wheels Ø125 2 fixed and 2 revolving, brought 120 Kg for plain



522 027 mm1000x600x840



Carrello porta attrezzi componibile, 3 vasche, ruote Ø80 2 fisse e 2 piroettanti

Cart brings utensils, 3 tubs, wheels Ø80 2 fixed and 2 revolving



522 02800 Rosso



522 02801-02 Blu

522 028 00	Portata 40 Kg per piano	mm 800x450x800
522 028 01	Portata 40 Kg per piano	mm 620x450x800
522 02802	Portata 60 Kg per piano	mm 800x400x800

Carrello porta bombole con ruote diametro 200 mm

Weeled trucks for tanks 200 mm wheels



522 029 600x1000 h mm - max 1300 h - colore grigio

Scaffale a caselle in lamiera verniciata a forno colore grigio

Shelf on steel

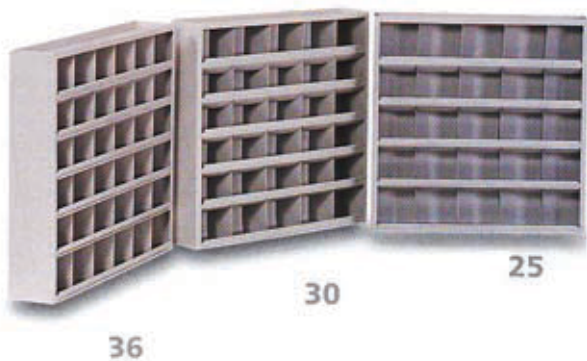

522 030	25 caselle	600x600x12 mm
522 031	30 caselle	600x600x12 mm
522 032	36 caselle	600x600x12 mm

Carrello portautensili con 6 cassetti

Colore RAL 5015-BLU



522 034	Carrello vuoto
522 035	Carrello completo con 175 utensili
522 036	Carrello completo con 118 utensili

Dati tecnici - Informative

- Portata max compressiva Kg 200 - Per cassetto kg 20
- Maniglie autobloccanti + serratura centralizzata con chiave
- 2 ruote sterzanti una delle quali con blocco di sicurezza

Composizione - Composition

175 Utensili

- 9 Bussole Tx Femmina 1/2"
- 7 Bussole con inserto Tx lungo 1/2"
- 7 Bussole con inserto Tx corto 1/2"
- 6 Bussole con inserto Es. lungo 1/2"
- 6 Bussole con inserto Es. corto 1/2"
- 3 Bussole con inserto XZN lungo 1/2"
- 3 Bussole con inserto XZN corto 1/2"
- 1 Cricchetto 1/4"
- 1 Impugnatura con Quadro 1/4"
- 1 Snodo 1/4"
- 1 Asta con quadro scorrevole 1/4"



- 2 Prolunghe (mm 50-100) 1/4"
- 7 Bussole Tx femmina 1/4"
- 12 Bussole surface 1/4"
- 18 Bussole inserti: Tx-Es-Ph-Tgl 1/4"
- 3 Brugole mm 1,5 - 2 - 2,5
- 10 Chiavi fisse: mm 6x7 - 30-32
- 15 Chiavi combinate: mm 6 - 22
- 8 Chiavi poligonali curve: mm 6x7 - 20x22

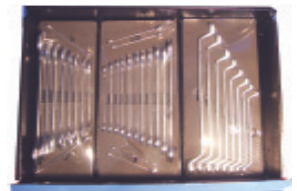

- 6 Cacciavite a battere Taglio
- 6 Cacciavite a battere Ph
- 1 Cricchetto 1/2"
- 20 Bussole surface 1/2"
- 1 Snodo 1/2"
- 2 Prolunghe (mm 125-250) 1/2"
- 2 Chiave candela mm 16 / 21



- 1 Pinza tagliacavi
- 1 Pinza becchi lunghi
- 1 Pinza poligrip
- 1 Pinza grip autobloccante



- 1 Martello gr 500
- 1 Seghetto
- 8: Scalpelli - Bulini - Cacciaspine
- 1: Punta atracciare



Composizione - Composition

118 Utensili

- 1 Cricchetto 1/4"
- 1 Impugnatura con Quadro 1/4"
- 1 Snodo 1/4"
- 1 Asta con quadro scorrevole 1/4"



- 2 Prolunghe (mm 50-100) 1/4"
- 7 Bussole Tx femmina 1/4"
- 12 Bussole surface 1/4"
- 18 Bussole inserti: Tx-Es-Ph-Tgl 1/4
- 3 Brugole mm 1,5 - 2 - 2,5

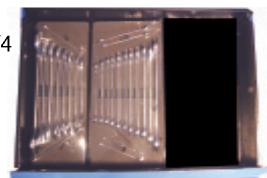

- 10 Chiavi fisse: mm 6x7 - 30-32
- 15 Chiavi combinate: mm 6 - 22



- 6 Cacciavite a battere Taglio
- 6 Cacciavite a battere Ph
- 1 Cricchetto 1/2"
- 20 Bussole surface 1/2"
- 1 Snodo 1/2"
- 2 Prolunghe (mm 125-250) 1/2"
- 2 Chiave candela mm 16 / 21



- 1 Pinza tagliacavi
- 1 Pinza becchi lunghi
- 1 Pinza poligrip
- 1 Pinza grip autobloccante



- 1 Martello gr 500
- 1 Seghetto
- 8: Scalpelli - Bulini - Cacciaspine
- 1: Punta atracciare



Banco da lavoro in ferro componibile con piano in lamiera e 3 bordi cm. 3

Work bench on steel with drawer and board

Colore RAL 5015-BLU



522 043	1000x700x850h	portata 700 kg.
522 044	1500x700x850h	portata 600 kg.
522 045	2000x700x850h	portata 400 kg.

Banco da lavoro monoblocco con piano in lamiera con 3 bordi da 3 cm.

Colore RAL 5015-BLU



522 043 01	1000x700x850h	portata 700 kg.
522 044 01	1500x700x850h	portata 600 kg.
522 045 01	2000x700x850h	portata 400 kg.

Banco da lavoro in ferro monoblocco con piano in legno

Colore RAL 5015-BLU



522 043 02	Piano in legno	1000x700x890h	portata 700 kg.
522 044 02	Piano in legno	1500x700x890h	portata 600 kg.
522 045 02	Piano in legno	2000x700x890h	portata 400 kg.

Banco da lavoro in ferro componibile con piano in legno

Work bench on steel with drawer and board

Colore RAL 5015-BLU



522 046	1000x700x890h	portata 700 kg.
522 047	1500x700x890h	portata 600 kg.
522 048	2000x700x890h	portata 400 kg.

Esempi di composizione



Cassettiera 1 cassetto con serratura

Single drawer unit

Colore RAL 5015-BLU



522 049 01 mm 505x580x210h

Cassettiera 1 cassetto + vano con serratura

Single drawer unit with 1 compartment with door

Colore RAL 5015-BLU



522 049 02 mm 505x580x600h

Cassettiera 3 cassetti, 1 cassetto con serratura

Single drawer unit with 1 drawer with locking drawer

Colore RAL 5015-BLU



522 049 03 mm505x580x600h

Banco da lavoro con piano in lamiera e un bordo dietro. 1 cassetto.

Colore Grigio



522 050 1000x700x900h

522 051 1500x700x900h

Banco da lavoro con piano in lamiera e un bordo dietro. 2 cassetti.

Work bench on steel with 2 drawer



522 052 2000x750x900h

Banco da lavoro con 2 cassetti e vano con ante

Workbench with 2 drawer units and a compartment with door

Colore RAL 5015-BLU



522 060 mm 1000x700x850 portata 2000kg

Banco da lavoro con 2 cassetti,vano laterale e inferiore con ante

Workbench with 2 drawer units, a compartment on one side and another underneath with door

Colore RAL 5015-BLU



522 061 mm1000x700x850 portata 2000kg

Banco da lavoro con 4 cassetti, 2 vani laterali e 2 inferiori con ante

Workbench with 4 drawer units, 2 compartment on one side and another 2 underneath with door

Colore RAL 5015-BLU



522 062 mm2000x700x850 portata 1500kg

Pannello in lamiera forata e mensola smontabile

Driller sheet tool panel with removable shelf

Colore RAL 5015-BLU



522 090 Fori mm 4 mm1000x850

522 091 Fori mm 4 mm1500x850

522 092 Fori mm 4 mm2000x850

Pannelli con foro tondo per utensili

Tool boards



colore grigio

522 102 1000x500h **522 104** 2000x500h

522 103 1500x500 h

Pannelli forati tondi per utensili con mensola

Tool boards



colore grigio

522 106 1000x850 h **522 108** 2000x850 h

522 107 1500x850 h

Gancio a tre punte per pannello forato

Thooks for perforated steel plate



522 111 40 mm

Gancio filettato per pannello forato

Thooks for perforated steel plate



522 113 50 mm

Gancio a L per pannello forato

Thooks for perforated steel plate



522 115

Gancio a U per pannello forato

Thooks for perforated steel plate



522 116

Gancio con piedino di appoggio mm 4



522 117 04 Lungh. mm 40 **522 117 10** Lungh. mm 100

522 117 06 Lungh. mm 60

Gancio ad occhiello con piedino di appoggio mm 4



522 118



www.afasupport.it

Scaffali stoccaggio copertoni con ripiani modulabili

Esempio di scaffale (522 160) da Mt.3,07 con 4 ripiani

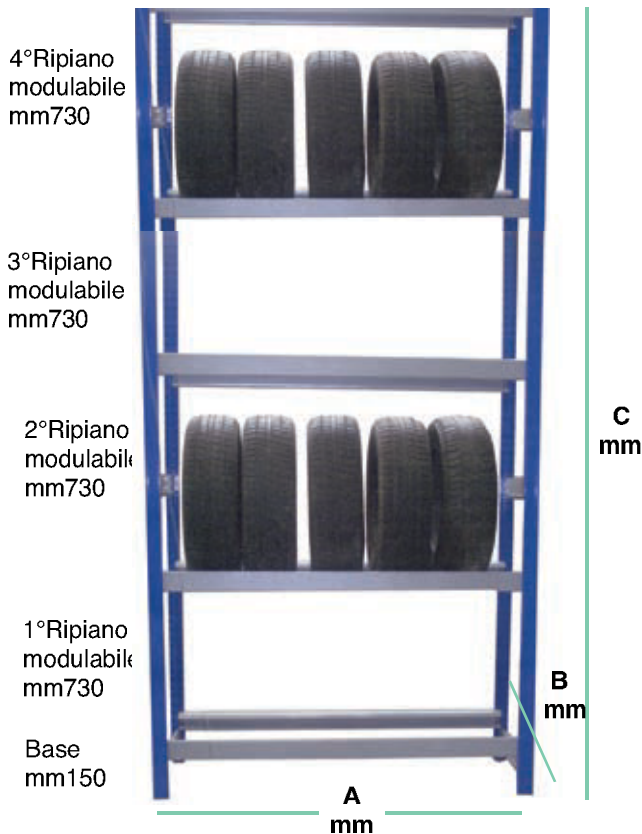

Nb: Disponibili solo di colore grigio - Distanziatore da parete optional

522 150	Ideale come 3 ripiani comodi per ruote berline / jeep A mm 1200 B mm 475 C mm 2000
522 155	Ideale come 4 ripiani per ruote utilitarie A mm 1200 B mm 475 C mm 2480
522 160	Ideale come 4 ripiani comodi per ruote berline / jeep A mm 1200 B mm 475 C mm 3007

Adattatori opzionali - Optional adaptor

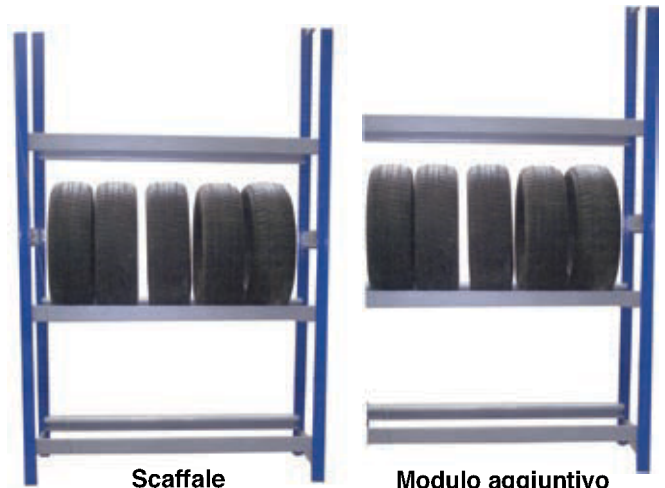

Scaffale portagomme

Modulo aggiuntivo

Moduli aggiuntivi da applicare agli scaffali portagomme

522 151	Modulo aggiuntivo per 522 150 1 fiancata mm 2000+3 correnti
522 156	Modulo aggiuntivo per 522 155 1 fiancata mm 2480+4 correnti
522 161	Modulo aggiuntivo per 522 160 1 fiancata mm 3007+4 correnti

Ricambi - Change parts

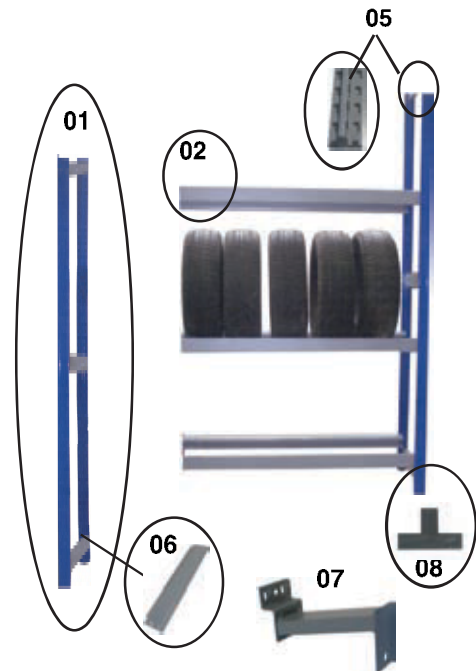

Ricambi per scaffale stoccaggio gomme

522 150 01	Fiancata (mm 2000) con traverse
522 150 02	Corrente portagomme (mm 1200)
522 150 05	Montante singolo con piede (mm 2000)
522 150 06	Traversa singola (mm 475)
522 150 07	Distanziatore da parete (mm 110)
522 150 08	Piedino di plastica per montante

Cassette portautensili

Tool chest



522 202	400x200x105mm	1 scomparti
522 205	400x200x160mm	3 scomparti
522 206	450x200x160mm	3 scomparti
522 207	520x200x160mm	3 scomparti
522 211	400x200x200mm	5 scomparti
522 212	450x200x200mm	5 scomparti
522 213	520x200x200mm	5 scomparti

Valigetta portautensili in moplen vuota

Tool bag by Moplen without compartment



522 241	Misure 334x151x146 mm
---------	-----------------------

Valigetta portautensili in moplen vuota

Tool bag by Moplen without compartment



522 242	Misure 120V - 380x166x125 mm
---------	------------------------------

Valigetta portautensili in moplen con un ripiano

Tool bag by Moplen one compartment



522 243	Misure 334x150x146 mm
522 244	Misure 410x185x135 mm

Valigetta in moplen con cestino asportabile



522 248	380x260x220h
---------	--------------

Valigetta in polipropilene con 2 spugne bugnate

Tool bag by propilen with 2 spoons



522 251	170-24P GPB	Mis 230x165x42 mm
522 252	170-31 GPB	Mis 315x230x57 mm
522 253	170-36 GPB	Mis 345x255x72 mm

Valigetta in polipropilene con 2 spugne bugnate

Tool bag by propilen with 2 spoons



522 255	390x295x102 mm
---------	----------------

Valigetta in polipropilene con 2 spugne bugnate

Tool bag by propilen with 2 spoons

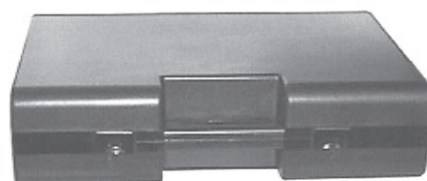

522 256	170-38 GPT	Mis 375x275x86 mm
522 257	170-42 GPT	Mis 420x300x105mm
522 258	170-51 GPT	Mis 500x370x125mm

Valigetta in polipropilene con 2 spugne

Tool bag by propilen with 2 spoons



522 261	180-21	Mis 200x160x45 mm
522 262	180-37	Mis 360x160x45 mm
522 263	180-43	Mis 420x160x45 mm

Valigetta in polipropilene con 2 spugne

Tool bag by propilen with 2 spoons



522 271	200-C	Mis 310x104x40 mm
522 272	200-L	Mis 388x104x40 mm

Borsa per elettricista in cuoio fiore nera.

Bag for electricians on leather with metal finishing and reinforced internal



Angolari fascette borchie di appoggio in metallo zincato. Interno rinforzato con laminato 2 mm. Cinghia tracolla in polipropilene

523 001	Misure interne	320x210x120 mm
523 002	Misure interne	350x240x120 mm
523 003	Misure interne	380x240x120 mm
523 004	Misure interne	410x270x120 mm

Borsa per elettricista in cuoio fiore nera.

Bag for electricians on leather with 4 mm plastic division



Divisorio in laminato plastico 4 mm. Cinghia tracolla in polipropilene

523 011	Misure interne -	410x270x200 mm
---------	------------------	----------------

Borsa per idraulici in cuoio stampato fiore nero. Rivestimento totale con laminato plastico 2 mm. Cinghia a tracolla in polipropilene

Bag for hydraulic on leather with 2 mm plastic cover



523 012	Misure interne	410x185x180 mm
523 013	Misure interne	460x185x180 mm
523 014	Misure interne	640x185x180 mm

Borsa per idraulici in cuoio stampato fiore nero. Rivestimento totale con laminato plastico 4 mm. Cinghia a tracolla in polipropilene

Bag for hydraulic on leather with 4 mm plastic cover



523 021	Misure interne	640x270x270 mm
---------	----------------	----------------

Tasca porta utensili in cuoio fiore con 5 guaine esterne portautensili.

Tool bag with tools holders



Passante porta martello Moschettone aggancio mazzuola. Dispositivo porta nastro e alloggiamento fisso per giraviti con tasca da 220x220x50 mm

523 025	Misure	250x265 mm
---------	--------	------------

NOTE

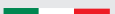

Tasca porta utensili con passanti porta martelli

Tool bag with tools holders

Cuoio

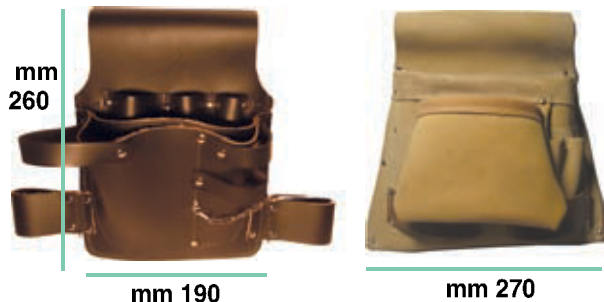

- alloggiamenti per cacciaviti o simili
- marsupio anteriore per chiodi
- 1 tasca grande con passanti porta martelli - alloggiamenti per cacciaviti o simili
- 1 tasca grande - 1 tasca piccola

523 026 Tasca portatutto cuoio economica

523 027 Tasca portatutto pelle scamosciata

Borsa per riparatore tipo economico. Cinghia tracolla

Bag for electricians on leather



523 036 Misure interne 350x250x120 mm

523 037 Misure interne 350x250x140 mm

Borsa America in cuoio stampato fiore nera. Divisorio in laminato plastico due serrature a scala

Bag America type on leather with plastic division



523 041 Misure 440x300x160 mm

Borsa per operai tecnici in cuoio stampato fiore nera

Bag for electricians on leather with 2 mm plastic division



Rivestimento in laminato plastico 2 mm. Con passanti scorrevoli serratura cinghia tracolla in polipropilene 40 mm. Frontale ribaltabile e pannello interno estraibile su guide

523 043 Misure interne - 460x300x200 mm

Borsa per operai riparatori in cuoio stampato fiore nera.

Bag for electricians on leather with 2 mm plastic division



Con passanti scorrevoli serratura cinghia tracolla in polipropilene 40 mm. Frontale ribaltabile

523 044 Misure interne - 380x270x170 mm

Borsa vuota per operai riparatori in cuoio stampato fiore nera rinforzata con laminato plastico.

Bag for electricians on leather with 2 mm plastic division



Passanti scorrevoli, serrature, cinghia, tracolla in polipropilene, frontale ribaltabile, misure interne

523 045 Misure interne - 410x300x160 mm

Borsa in cuoio con fasce portautensili interne, due tasche esterne laterali e cinghia per tracolla

Bag on leather



523 046

Bauletto porta utensili in fibra con rinforzi metallici frontale ribaltabile passanti per utensili cinghia tracolla

Tool bag on fiber



523 051 Misure interne - 400x300x170 mm

Bauletto porta utensili in fibra con rinforzi metallici cinghia tracolla

Tool bag on fiber



523 055 Misure interne 400x200x200 mm

Bauletto porta utensili in fibra con rinforzi metallici cinghia tracolla

Tool bag on fiber



523 056 Misure interne 500x200x200 mm

Valigia in alluminio porta utensili (Utensili non inclusi)

Aluminium tool case - (Tools not included)

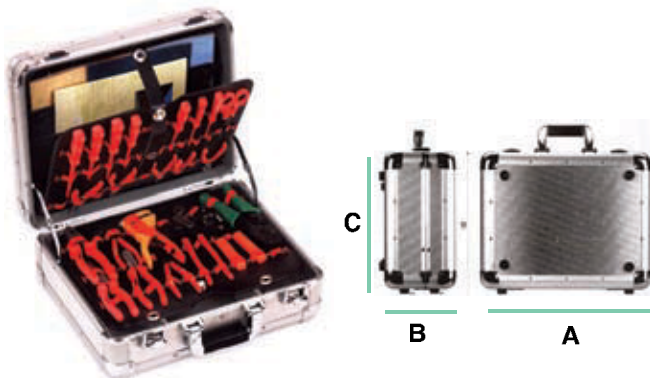

	A	B	C	Kg
523 100	mm 510	mm 185	mm 375	5,8

Cassettiera porta attrezzi 6 cassetti e vaschetta superiore



523 500 Dim: 34x66x38H

Pennelli industriali in pura setola manico in polipropilene

Brush with plastic handle



525 001	Diam. 8 mm	525 005	Diam. 16 mm
525 002	Diam. 10 mm	525 006	Diam. 18 mm
525 003	Diam. 12 mm	525 007	Diam. 20 mm
525 004	Diam. 14 mm	525 008	Diam. 22 mm

Pennelli industriali in pura setola manico in legno

Brush with wood handle



525 011	Diam. 10 mm	525 015	Diam. 18 mm
525 012	Diam. 12 mm	525 016	Diam. 20 mm
525 013	Diam. 14 mm	525 017	Diam. 22 mm
525 014	Diam. 16 mm		

Pennellessa in pura setola manico in polipropilene

Brush flat with polipropilene handles



525 021	Spessore h. 20 mm x 9	
525 022	Spessore 30 mm x 9	
525 023	Spessore h. 40 mm x 9	
525 024	Spessore h. 50 mm x 9	
525 025	Spessore h. 60 mm x 9	
525 026	Spessore h. 70 mm x 9	

Pennellessa in pura setola manico in polipropilene

Brush flat with propilene handles



525 031	Spessore 15 mm	h. 20 mm
525 032	Spessore 15 mm	h. 30 mm
525 033	Spessore 15 mm	h. 40 mm
525 034	Spessore 15 mm	h. 50 mm
525 035	Spessore 15 mm	h. 60 mm
525 036	Spessore 15 mm	h. 80 mm

Pennello piatto in pura setola per radiatori manico in legno

Brush flat with wooden handles



525 041	Spessore 9 mm	h. 20 mm
525 042	Spessore 9 mm	h. 30 mm
525 043	Spessore 9 mm	h. 40 mm
525 044	Spessore 9 mm	h. 50 mm
525 045	Spessore 9 mm	h. 60 mm

Pennellessa a fascia metallica e manico in polipropilene

Brush Flat with plastic handles



525 051	Spessore 40 mm	h. 140 mm
525 052	Spessore 50 mm	h. 150 mm

Spatola per stuccatori

Scraper



525 061	30 mm	525 065	70 mm
525 062	40 mm	525 066	80 mm
525 063	50 mm	525 067	90 mm
525 064	60 mm	525 068	100 mm

Traccialinee

Marker



525 070	Traccialinee mt. 20
525 071	Polvere per traccialinee

Pala per la neve normale e rinforzata

Square shovel for snow

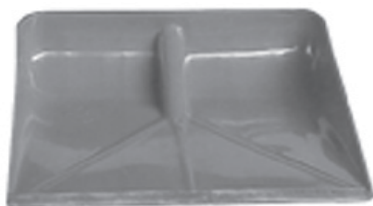

525 161	Normale
525 162	Banda metallica rinforzata
525 163	Manico

Pala piegevole multiuso in alluminio anodizzato



525 200	cm 95
525 201	Supporto da esposizione completo di 12 pale

Assortimento 120 spine elastiche

120 - pc roll pin set



550 001 in box di plastica

Assortimento 300 anelli elastici per alberi

300 - pc clip set



550 002 in box di plastica

Assortimento 100 anelli elastici

100 - pc snap ring set



550 003 in box di plastica

Assortimento 150 coppie di sicurezza

150 - pc hitch pin set



550 004 in box di plastica

Assortimento 555 coppiglie dritte

555 - pc cotter pin set



550 005 in box di plastica

Assortimento 200 molle

200 - pc spring set



550 006 in box di plastica

Assortimento 200 capicorda isolati aperti

200 - pc insulated terminal set



550 007 in box di plastica

Assortimento 400 capicorda isolati chiusi - a tubo

400 - pc insulated terminal set



550 008 in box di plastica

Composizione - Composition

Misure:	0,5	0,75	1,0	1,5	2,5
Pz:	50	100	100	100	50

Assortimento 720 rondelle

720 - pc washer set



550 009 in box di plastica

Assortimento 450 sfere d'acciaio cromate metriche

450 - pc metric chromed steel ball set



550 010 in box di plastica

Assortimento 127 guaine termorestringenti nere

127 PVC black shrinkable tube assortment



550 012 In scatola

NOTE



Batterie alkaline

Samsung



600 010	AAA	Pz 4.
600 011	AA	Pz 4.
600 012	C	Pz 2.
600 013	D	Pz 2.
600 014	Batteria alcalina 9 V.	

Chiave candela con gommino pinza-candele

Spark plug with rubber pliers

Zincata



	A	B	Indicata per
700 001	mm 80	mm 16	
700 002	mm 90	mm 13	Piaggio 4T
700 003	mm 100	mm 16	
700 004	mm 120	mm 18	
700 005	mm 120	mm 21	
700 006	mm 135	mm 13	Honda zommer 50

Micrometro per la messa a punto motori a 2 tempi

Micrometer timing for 2 stroke engines

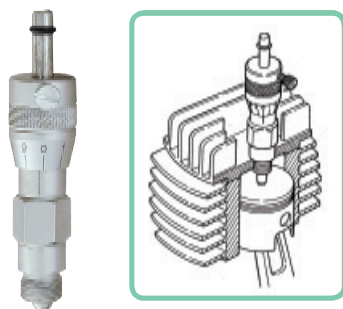

700 050 M = 14 x 1,25

NOTE



Attrezzo comprimi molla ammortizzatore posteriore scooter e minimoto

Pear coil spring compressor for scooter and minibike



700 065 A = Min mm 23 - Max mm 115

Robusta pressa comprimi molla

Extra strong spring compressor tool

Per ammortizzatori
lunghezza max:
mm 440



700 070

Chiave autoserrante reversibile per filtri olio

Reversible filter wrench



217 090 Ø 66 - 83

Avviatore portatile

Portable battery charger

Con pinze ridotte ideali per
vetture, moto & scooter



Amperaggio di spunto
1400A - 12V



251 266 P10 - 1400A - 12V

Pinza componibile per seeger interni ed esterni

Combination internal / External circlip plier set

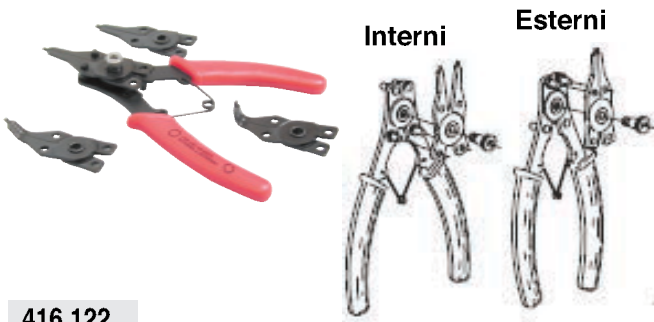

416 122

Kit 4 ganci in acciaio inox con impugnatura



241 041 Box plastica formato soft

Attrezzo universale spingi molle per valvole

Universal valve spring compressor tool



700 100

Dati tecnici - Informative

Apertura massima: mm 175
 Profondità: mm 125
 Contiene: 5 adattatori: mm 16 - 19 - 23 - 25 - 30
 3 viti di compressione: mm 50 - 90 - 110

Kit cacciavite con rinvio angolare a 90° con inserti taglio e croce (ideale per riparazione carburatori)

Carburetor adjusting set with 90° rotation



411 170

Sincronizzatore -vuotometro- per carburatori

Carburetor synchronizer



Ideale per:
 Auto e moto
 a 2 & 4
 carburatori

252 530 In valigetta

Composizione - Composition

- 4 Sincronizzatori
- Gamma di pressione: 0 / -76cmHg
- 4 Tubi flessibili di gomma: 8 x 5 x 950mm
- 4 Connettori di estensione: M5 x 0.8 x 53
- 4 Connettori di estensione: M5 x 0.8 x 100
- 4 Connettori di estensione: M5 x 0.8 x 169
- 4 Connettori di estensione: M6 x 0.75 x 53
- 4 Connettori di estensione: M6 x 1.0 x 60
- 1 Connettori di estensione: M6 x 55

Kit pompa vuoto e carico con raccordi

Vacuum testing / brake bleeding kit



252 543

Dati tecnici - Informative

Pompa in metallo per creare e mantenere il sottovuoto
 Ideale per: Valvole del carburatore, sostituzione e messa in pressione olio freni, pompa carburante, test valvole di regolazione della presa aria moto, test iniezione elettronica
 La confezione include adattatori, tubi e vaschetta raccogli liquido.

Attrezzo universale regolazione punterie per motore scooter 4t con 3 guide esagonali di mm 8, 9, 10

Tappet adjust universal tool

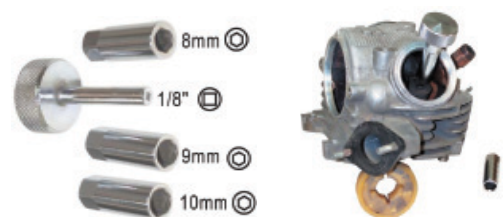

700 120

Tester di controllo compressione nel cilindro

Compression cylinder control test



700 140 In valigetta

Ricambi - Spare parts

Manometro - N°3 tubi con innesto mm 10, 12, 14

Dati tecnici - Informative

Dispone di una valvola di rapido scarico della pressione e di un misuratore con capacità di 300 PSI
Kit completo di manometro e tre tubi con innesto mm 10,12,14

Tester per il controllo della perdita di pressione nel cilindro dei motori a 4 tempi

4 Stroke leak down tester



700 141 In valigetta

Ricambi - Spare parts

Manometro - Regolatore - N°3 tubi con innesto mm 10, 12, 14

Dati tecnici - Informative

*Il misuratore registra in percentuale e in PSI le perdite delle fasce elastiche, guarnizioni della testa e valvole di aspirazione e di scarico. Con una presa d'aria compressa da 70 a 160 PSI questo sistema pressurizza il cilindro a 60 PSI permettendo la localizzazione delle parti usurate o danneggiate.

Attrezzo allarga pinza freno

Open brake disk tool

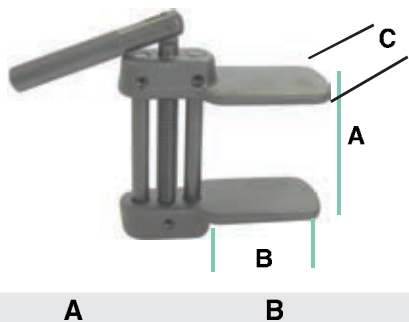

235 112 apertura max 81 profondità mm 70 becchi mm 51

Spazzolino pulisci catena con spazzole regolabili

Chain brush with adjustable brush

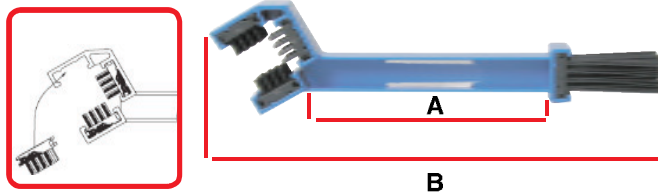

	A	B
700 160	mm 135	mm 260

Kit lavaggio catena

Chain cleaner



700 165 Kit completo di contenitore, tubetti per introduzione e scarico detergente, ganci e corde di fissaggio

Pinza smonta / rimonta maglia delle catene

Remove / install chain clip pliers

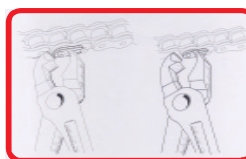

700 170

Attrezzo smonta / monta catena

Disassembling / assembling chains tool

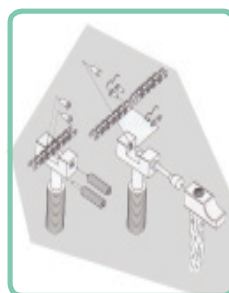

700 180 In valigetta

Ricambi - Spare parts



700 180 01 Set 3 viti di ricambio: Viti da M16 con spina corta e con spina lunga, vite a punta conica per allargare le catene con piolo forato

Dati tecnici - Informative

Con viti a puntale e viti a punta conica per allargare il piolo forato
Il set è composto di punzone rivettatore per catene RIF:
415 - 420 - 428 - 520 - 525 - 530 - 532

Attrezzo smonta / monta catene di distribuzione

Disassembling / assembling chains tool

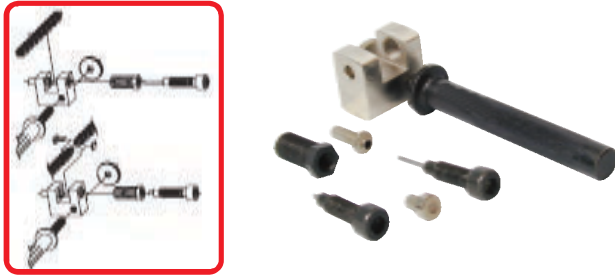

700 185

Chiave regolabile per ghiera a settore

Adjustable locking ring sector tool

Acciaio
cromo-vanadio

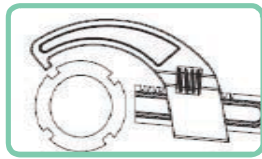

700 200 Min. mm 25 - Max mm 70

Attrezzo universale blocca volano e campana frizione completo di fermo

Universal tool to hold flywheel and clutch pulleys complete with stopper



mm 320

700 215 Con perni da 5 e 9 mm
Apertura con fermo da 50 a 140 mm

Attrezzo universale blocca volano e campana frizione

Universal tool to hold flywheel and clutch pulleys



700 220

Filo in acciaio INOX

Stainless safety wire



700 250 Spessore mm 0,6 - Bobina mt. 200

Pinza torcifilo a ritorno automatico

Safety-wire twister



416 550

Attrezzo universale per smontaggio cuscinetto albero motore

Universal crank bearing puller tool



mm
190

700 260 Da Ø 30 a Ø 75 con attrezzi in acciaio forgiato

Estrattore universale

Universak puller



700 270

Dati tecnici - Informative

Per lo smontaggio del mozzo frizione, di alcuni tipi di alternatore, di ingranaggi e pignoni

Estrattore in valigetta con prolunghe e flangia per cuscinetti e ingranaggi - Vite di pressione per serraggio veloce

Bearing puller set with prolung



Prolunghe
mm 100

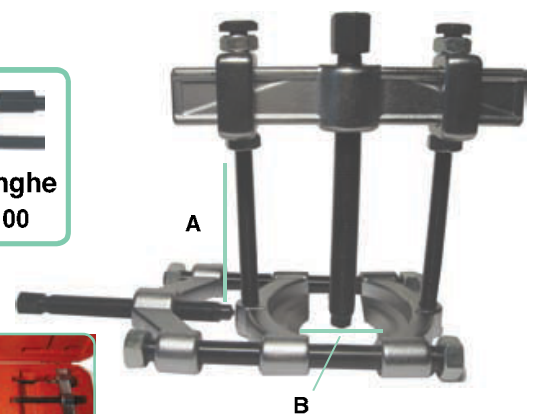

A

B

141 403 mm 100 (mm 200 con prolunghe) mm 12 - 75

Attrezzo piantaggio guarnizioni forcella - Aperto

Open fork seal driver tool



700 280	Steli Ø 40	700 284	Steli Ø 47
700 281	Steli Ø 43	700 285	Steli Ø 48
700 282	Steli Ø 45	700 286	Steli Ø 49
700 283	Steli Ø 46	700 287	Steli Ø 50

Serie di estrattori per cuscinetti nel carter

Blind hole bearing puller set



700 300

Dati tecnici - Informative

Apertura estrattore: Min 26 - Max 66 mm

- 1 Pinza ad espansione mm 8
- 1 Pinza ad espansione mm 10
- 1 Pinza ad espansione mm 12
- 1 Pinza ad espansione mm 15
- 1 Pinza ad espansione mm 17
- 1 Pinza ad espansione mm 20
- 1 Pinza ad espansione mm 25

Attrazzo a 4 esagoni per bloccare il perno della ruota anteriore



700 310 Esagoni mm 17 - 19 - 22 - 24

Levagomme con forte curvatura

Acciaio al cromo molibdeno

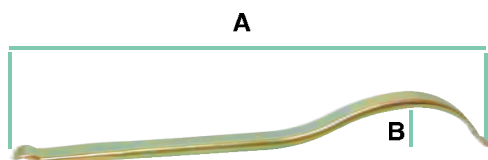

700 320 mm 371 (A) mm 48 (B)

Dati tecnici - Informative

Particolarmente adatta per pneumatici con la mousse (tyre-balls) e ogni tipo di pneumatico

Serie di levagomme da mm 200

Acciaio al carbonio

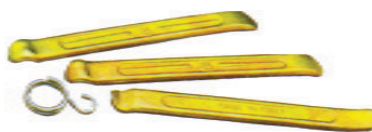

700 323 3 pz con gancio

Dati tecnici - Informative

Con gancio di fissaggio al raggio

Serie di 3 Pz levagomme "professional"

Tyre tool professional pz 3



700 326 In astuccio

Dati tecnici - Informative

- 2 levagomme da mm 350
- 1 levagomme da mm 240
- Gancio di fissaggio al raggio

Attrezzo blocca copertone per ruote a raggi

Tyre locating lever

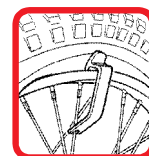

700 330

Cavalletto posteriore di parcheggio smontabile

Disassembling rear working stand

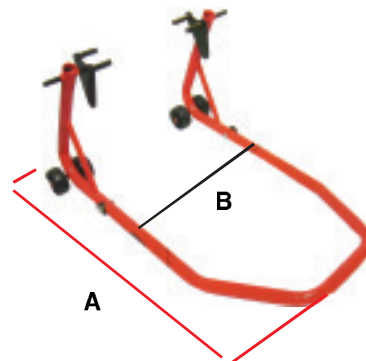

700 350 A mm 760 B mm 460

Dati tecnici - Informative

- Tubo mm32
- Ruote gemellate
- Bracci di carico rinforzati

Cavalletto posteriore di parcheggio smontabile

Disassembling rear working stand

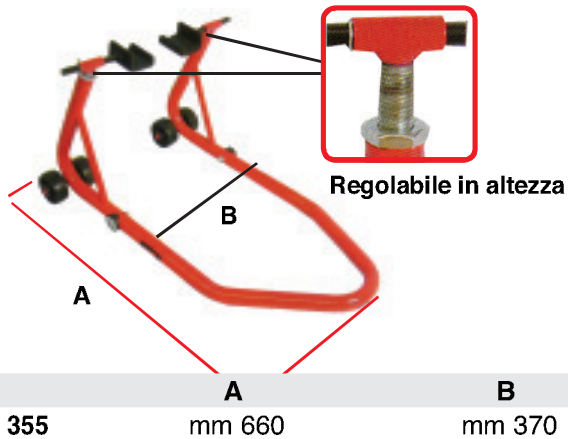

700 355 mm 660 mm 370

Dati tecnici - Informative

Regolabile in altezza: da mm 340 a mm 400 per ruote fino 19"
 Tubo mm32
 Ruote gemellate
 Bracci di carico rinforzati

Recuperatore olio esausto per moto

Tank recovery exhausted oil for moto



Indicatore di livello - Svuotamento pneumatico
 Coppa recupero orientabile

514 238 40 Lt

Deviazioni a Y per scarichi doppi

Deviation of Y complete two lengths of hose



	Per tubo	Spezzoni
515 821 01	Ø 75	Ø 75 x mt 1.25
515 821 02	Ø100	Ø 75 x mt 1.25
515 821 03	Ø100	Ø 100 x mt 1.25

Dati tecnici - Informative

Disponibili in 3 versioni, complete di due spezzoni di tubi antischiacciamento da Mt. 1,25 ciascuno.
 Utilizzabile con: 515 812 & 515 812 01

Bocchette tonde, senza e con tappo, con ingresso per sonda, disponibile in quattro versioni

Round nozzle with cap available in four versions



	Per tubo	Cono
515 824 01	Ø 75	Ø 165 Senza tappo
515 824 02	Ø 100	Ø 165 Senza tappo
515 824 03	Ø 75	Ø 165 Con tappo
515 824 04	Ø 100	Ø 165 Con tappo

Sollevatore idraulico per moto con pompa a pedale

Hydraulic motorcycle lift table with foot pump



520 440

Dati tecnici - Informative

Capacità di sollevamento: Kg 400
 Dimensioni della piattaforma: mm 1825 x 660
 Altezza di sollevamento: Min 195 - Max 750 mm
 Peso: Kg 173

Rampe in alluminio

Aluminum ramps

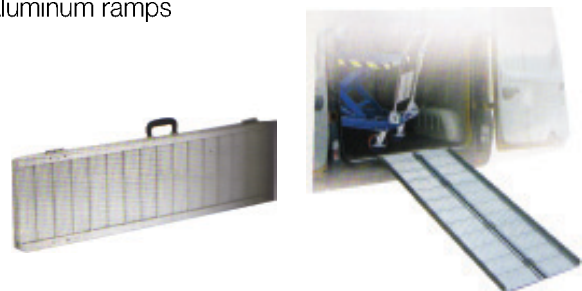

520 445 Portata Kg150 - Dimensioni cm180x73,5 - Peso Kg16

520 446 Portata Kg170 - Dimensioni cm150x73,5 - Peso Kg13

Sollevatore per moto

Motor-bike hoists



Art. 196 OMCN

Dati tecnici - Informative

*Estremamente pratici e maneggevoli, sono dotati di una speciale morsa meccanica per il bloccaggio della ruota anteriore
 *Peso: 165 Kg.
 *Portata: 0,3 ton.

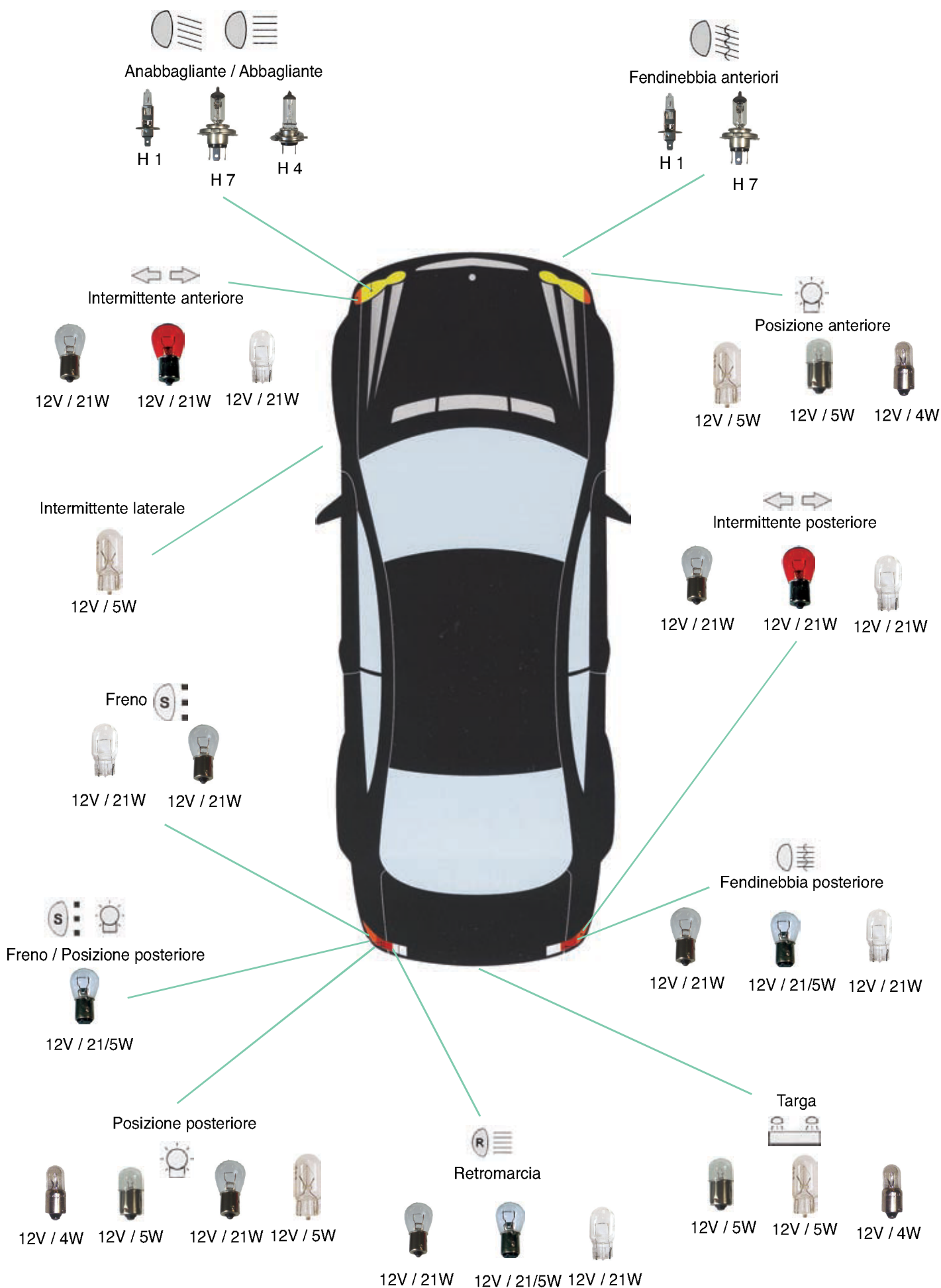

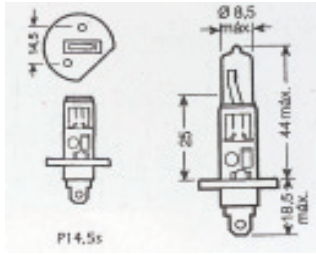

Lampadine per auto

H - 1

Lamps for car

	V	W	Base	Pz
800 001 12	12	55	P 14,5 s	1
800 001 24	24	70	P 14,5 s	1

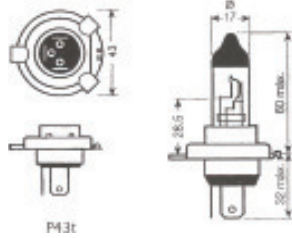

Lampadine per auto

H - 4

Lamps for car

	V	W	Base	Pz
800 004 12	12	60 / 55	P 43 t	1
800 004 24	24	75 / 70	P 43 t	1

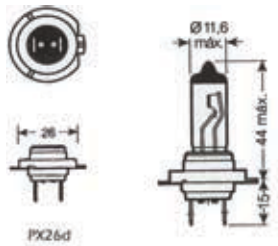

Lampadine per auto

H - 7

Lamps for car

	V	W	Base	Pz
800 007 12	12	55	PX 26 d	1
800 007 24	24	70	PX 26 d	1

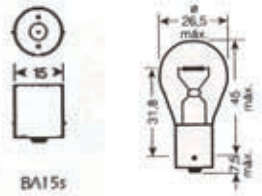

Lampadine per auto

Stop 1 filamento

Lamps for car

	V	W	Base	Pz
800 020 12	12	21	Ba 15 s	12
800 020 24	24	21	Ba 15 s	12

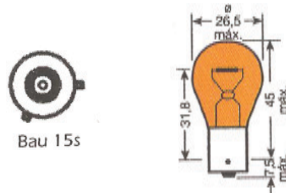

Lampadine per auto

Stop 1 filamento

Lamps for car

	V	W	Base	Pz
800 030 12	12	21	Bau 15 s	12

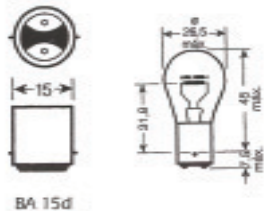

Lampadine per auto

Stop 2 filamento

Lamps for car

	V	W	Base	Pz
800 040 12	12	21 / 5	Bay 15 d	12
800 040 24	24	21 / 5	Bay 15 d	12

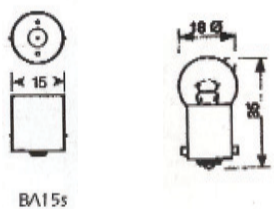

Lampadine per auto

1 filamento 1 Polo

Lamps for car

	V	W	Base	Pz
800 050 12	12	5	Ba 15 s	12
800 050 24	24	5	Ba 15 s	12
800 051 24	24	10	Ba 15 s	12

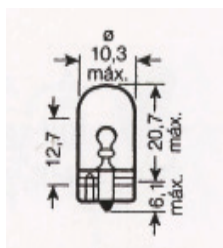

Lampadine per auto

T - 10

Lamps for car

	V	W	Base	Pz
800 060 12	12	5	W 2,1 X 9,5 d	25
800 060 24	24	5	W 2,1 X 9,5 d	25

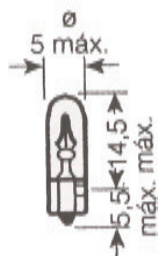

Lampadine per auto

T - 5

Lamps for car

	V	W	Base	Pz
800 070 12	12	1,2	W 2 X 4,6 d	25



800 080 12 800 090 12

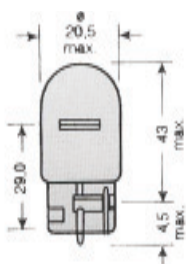

Lampadine per auto

T - 20

Lamps for car

	V	W	Base	Pz
800 080 12	12	21	W 3 x 1,6 d	12
800 090 12	12	21	W 3 x 1,6 d	12

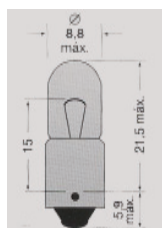

Lampadine per auto

Lamps for car

	V	W	Base	Pz
800 101 12	12	4	Ba 9 s	25
800 101 24	24	4	Ba 9 s	25

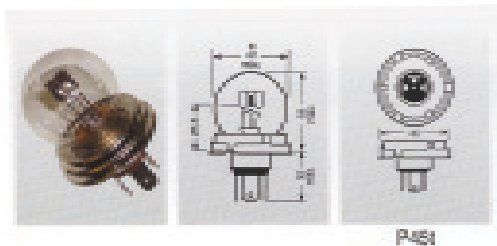

Lampadine per auto

R2 - Assimetrica

Lamps for car

	V	W	Base	Pz
800 105 12	12	45 / 40	P 45 t	1

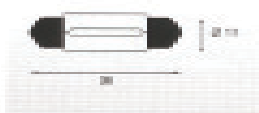

Lampadine per auto

11 x 38

Lamps for car

	V	W	Base	Pz
800 140 12	12	5	Sv 8,5	12
800 140 24	24	5	Sv 8,5	12
800 141 12	12	10	Sv 8,5	12



Lampadine per auto

15 x 44

Lamps for car

	V	W	Base	Pz
800 160 24	24	18	Sv 8,5	12