

Termometro ad immersione

Diving thermometer



216 032 Diam. 5 mm - L. 200 mm - 0° - 160° C

Set provaradiatori universale

Universal set for radiator



216 033 In valigetta - Pz 18

Ricambi - Spare-parts



216 033 01 Pompa



216 033 02 Raccordo R-123 - R-124

216 033 03 Raccordo R-123 - R-125



216 033 04 GM Buick-Jeep-Mercedes
Peugeot-Subaru-Mazda-Chrisler-Acura-

216 033 05 Nissan - GM (Nova-Spectrum-Sprint)-
Mitsubishi-Mazda-Geo - Toyota-Suzuki-
Infinity-Isuzu-Ford

216 033 06 Honda - Toyota - Suzuki-Mitsubishi-Chrisler-
Acura

216 033 07 Mercedes ML-GM(Achiva-Skylark-
Grand Am 1992/ 2002)

216 033 08 Volvo-Saab-Citroen-Renault-Fiat-Sterling-
Alfa

216 033 09 Vw(Vento-T4-Passat 1996-Golf-Beetle-
Sharan)

216 033 10 Audi(A4-A5-A6)-BMW345-Passat 1997/2002
- Porsche Chayenne

216 033 11 BMW

216 033 12 Audi - VW

216 033 13 Ford-Opel-Land Rover-Jaguar-Mercedes

216 033 14 Mercedes Classe C - E - S

216 033 15 Ford

216 033 16 Mazda M3



216 033 17 Termometro doppia scala °C - F

Set prova-radiatori Universale con attrezzo a depressione per il rapido riempimento dei radiatori

Radiator pressure tester & Vacuum type cooling system



216 034 in valigetta

Note: ideale per mettere in pressione, riempire e pulire.

NOTE



Set prova-radiatori Zeca

Zeca Radiator tester



216 035 in valigetta - Pz. 18

Ricambi - Spare-parts



- 216 037 Tappo 416.10 per: Chevrolet - Ford - Opel - Saab - Vw group
- 216 041 Tappo 416.05 per: Fiat group - Nissan - Mini - Renault - Rover - PSA - Volvo
- 216 042 Tappo 416.45 Per: Mercedes 1
- 216 043 Tappo 416.35 per: Vw Group - Porsche
- 216 050 Tappo 416.40 per: Ford
- 216 051 Tappo 416.24 per: BMW 2
- 216 052 01 Tappo 416.85 per: BMW 1
- 216 052 02 Tappo 416.30 per: Fiat group-Opel-Saab
- 216 052 03 Tappo 416.65 per: Mercedes 2
- 216 052 04 Tappo 416.70 per: Fiat - Suzuki - Toyota - Mitsubishi
- 216 052 05 Tappo 416.80 per: Ford - Mazda - Volvo
- 216 052 06 Tappo 416.55 per: Smart



216 052 07 Gruppo pompa 416.20



216 044 Tappo 416.66 Ø 40

216 045 Tappo 416.73 Ø 30



216 046 Tappo metallico Ø 41,5 - 416.75

216 047 Tappo metallico Ø 43,5 - 416.76



216 048 Attacco a baionetta 416.68

Attrezzo a depressione per il rapido riempimento dei radiatori ZECA 417

Cooling device for rapidly radiator filling ZECA 417



216 053

Termometro ad immersione a clip

Diving thermometer



216 055 Diam 25 mm - 250 ° F

Set per scollegare tubi carburante aria condizionata

Set for disconnect fuel and air conditioning pipe



216 058 Ford-Opel - 8 - 9 - 13 - 16 - 19 - 22 mm

Set scollamento tubi carburante ed impianti di condizionamento

Set of wrench for conditioning and gasoline tubes



216 059 5/16" - 3/8" - 1/2" - 5/8" - 3/4" - 7/8" - 1/4"

Set 4 pz. scollamento tubi carburante per raccordi angolari

Set of wrench for gasoline connectors



216 060 Alluminio anodizzato - 5/16" - 3/8" - 1/2" - 1/4"

Set sganciatori tubi climatizzatori con molle springlock

Springlock set



216 061 in valigetta

Composizione / Composition

4 sganciatori springlock Rosso-Blu-Nero-Bianco
4 sganciatori a pinza Rosso-Blu-Nero-Bianco
40 springlock (10x) G6 - G8 - G10 - G12

Serie chiavi aperte per dadi impianti condizionamento

Set of wrench for conditioning



216 062 4 pz - 22-24-26-28 mm

216 063 6 pz - 20-22-24-26-28-30 mm

Set universale per impianti di condizionamento

Fuel & air conditioning line disconnect set

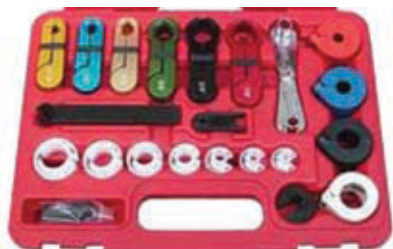

216 065 Pz 22

Chiave poligonale aperta per dadi radiatori

Wrench for radiator



216 070 29 mm

Estrattore puleggia climatizzatore Fiat - Alfa - Lancia

Extractor for conditioning pulley Fiat - Alfa - Lancia



216 072 22x1.5

Kit estrazione climatizzatore SANDEN

Kit for clima SANDEN



216 080

Kit per installare e rimuovere climatizzatori

For installation and removing air conditioned

Acciaio Cr. V.



216 081 Valigetta Pz 4

Dati tecnici - Informative

- Bussola con inserto intagliato mm 2.2 Att.1/4"
- Bussola con inserto intagliato mm 3.2 Att.1/4"
- Bussola SW 12 Att.1/4"
- Bussola SW 15 Att.1/4"

Attrezzo universale per valvola ricarica climatizzatori R12 & R134A

Valve core removers and installer R12 & R134A



mm 135

216 082

Blocca perdite totale

Complete leak stop



216 084

Dati tecnici - Informative

Ideale per risolvere i problemi di perdite sugli evaporatori, condensatori, tubi o-ring e in altri componenti sia in metallo che in gomma. Facile da usare, si inserisce anche a impianto carico
* Non occlude orifici e valvole d'espansione
* Non danneggia l'impianto A/C

Lampada ricaricabile a raggi UV per la rilevazione delle piccole falle dell'impianto dell'aria condizionata, più 3 potenti led bianchi

Led work light with UV-light on the top



216 085

Dati tecnici - Informative

Tempo di ricarica: 3.5 ore - Autonomia di luce: 3 ore
 Scocca in gomma antiurto e antiolio - Protezione IP 65
 2 caricatori: da muro 220V e accendisigari 12V

Liquido tracciante fluorescente per A/C

Line UV detector dye



216 086 (per 32 dosi) ml 237

216 086 75 (monodose) ml 7,5

Dati tecnici - Informative

Ideale per rilevare piccole falle dell'impianto aria condizionata degli autoveicoli
 Utilizzato sia nelle stazioni di ricarica sia con iniettore manuale

Olio lubrificante impianti A/C auto

Ester lubricant



216 087 Olio ISO 100 / 1 Lt.

Olio Pag sintetico al 100% specifico per R 134 A

PAG oil



216 088 01 Oil ISO 46 - 1Lt

216 088 02 Oil ISO 100 - 1Lt

218 088 03 Oil ISO 150 - 1Lt

Dati tecnici - Informative

Speciale formula che riduce la corrosione interna e l'usura del compressore.

Chiave ritegno puleggia compressore Denso climatizzatori Fiat Punto

Anti freezer gravity tester



216 090

Tubi in linea con rubinetto e depressore da 1/4" per stazioni di ricarica

1/4" Flexible hoses

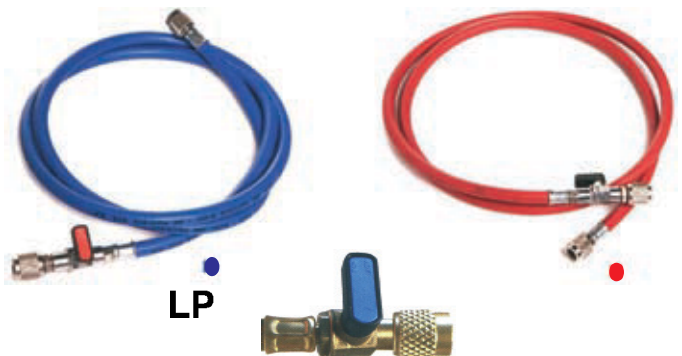

216 092 01 ● Alta pressione - Lungh. 1800 mm

216 092 02 ● Bassa pressione - Lungh. 1800 mm

Attacco rapido con volantino connessione 1/4" SAE

Quick coupler fitted with 1/4" SAE. M connection



216 094 01 ● Rosso - Alta pressione

216 094 02 ● Blu - Bassa pressione

Attacco rapido lungo per BMW, Volvo, Ford galaxy

Long in line connection for BMW, Volvo, Ford galaxy



216 094 03 Alta pressione

Demineralizzatore con cartuccia in resina per produrre fino a 100 Lt di acqua



216 150 Demineralizzatore
216 151 Cartuccia in resina

Dati tecnici - Informative

Pressione di alimento: Max 3 bar
Temperatura di alimento: Min.1° - Max 50°C

Densimetro per antigelo con termometro e scala di lettura compensata "Zeca"

Anti freezer gravity tester



216 101 Universale

Densimetro per antigelo

Anti freezer gravity tester



216 102 Universale

Densimetro per antigelo ECOPARAGEL

Anti freezer gravity tester



216 105 Universale

Set chiavi filtro olio - Pz 9

Oil filter wrench set - Pcs 9



217 000

Composizione - Composition

- | | | | |
|---|--------------------------|-----------------------|-----------------|
| 1° Attacco 3/8" | Lati 14 | Misura mm 64,5 | Tacche 3 |
| utilizzo: Allion, Auris, Corolla axio / fielder / Rumion, Isis, Its, Noha, Premio, Prius, Voxy, Wish | | | |
| 2° Attacco 3/8" | Lati 14 | Misura mm 74,2 | |
| utilizzo: Audi, Bmw, Ford, Mazda, Toyota, Volkswagen, Porsche, Mercedes (tutti i modelli V6 - V8) | | | |
| 3° Attacco 3/8" | Misura mm 63 / 83 | | |
| utilizzo: Chiave filtro olio universale | | | |
| 4° Attacco 3/8" | Lati 16 | Misura mm 86,6 | |
| utilizzo: 335i - 3.0 / 535i - 3.0 / bmw 3 serie (E 90) / X6 - 3.0 / Volvo (1999 - 2006) exc (2005 serie 40 & 50) | | | |
| 5° Attacco 3/8" | Lati 14 | Misura mm 64,5 | Tacche 1 |
| utilizzo: Toyota 2006 (universale) / 2007 & 2008 V6 / Lexus: 2007 ES 350 - GS 350 - GS 450h - LS 460 - RX 350 / Lexus: 2008 LS 600h L | | | |
| 6° Attacco 3/8" | Lati 15 | Misura mm 88,8 | |
| utilizzo: Hyundai / Kia | | | |
| 7° Attacco 3/8" | Lati 6 | Misura mm 27 | |
| utilizzo: Mercedes & Smart | | | |
| 8° Attacco 3/8" | Lati 6 | Misura mm 32 | |
| utilizzo: Opel vauxhall 4 cilindri / GM, 2,2L ecotech X10XE - X12XE - Y17DT - Y17DTL / Mercedes HGV'S e.g - OM 364 - OM 366 | | | |
| 9° Attacco 3/8" | Lati 6 | Misura mm 36 | |
| utilizzo: Mercedes OM 604 - OM 605 - OM 606 - Bmw M52 - 6cil. - M60 - 8cil. - M70 - 12cil. - Mini One - Cooper - Coopers - Ford 6Lt. Diesel VW VR6 (maggioranza Pickup) | | | |

Chiave filtri olio a fascia

Band wrench for oil filter cartridge



- | | |
|---------|---------------------|
| 217 001 | Universale - 80 mm |
| 217 002 | Universale - 90 mm |
| 217 003 | Universale - 100 mm |
| 217 004 | Universale - 110 mm |

Chiave filtri olio a fascia

Band wrench for oil filter



- | | | |
|---------|---------------------------------|------------|
| 217 005 | Offerta fino esaurimento scorte | mm 75 - 80 |
| 217 006 | Offerta fino esaurimento scorte | mm 80 - 90 |
| 217 007 | Offerta fino esaurimento scorte | mm 90 - 95 |

Chiave filtri olio a fascia con manico snodato made in U.S.A.

Band wrench for oil filter cartridge



- 217 016 Universale - 57-73 mm
- 217 017 Universale - 65-83 mm
- 217 018 Universale - 75-95 mm
- 217 019 Universale - 92-111mm

Chiave filtro olio a fascia con manico snodato

Band wrench for oil filter cartridge



- 217 020 12 Ø 100 - 120
- 217 02014 Per essiccati - Ø 120 - 146

Chiave filtri olio a fascia leggera con manico snodato

Band wrench for oil filter cartridge



- 217 021 Universale - 73-83 mm
- 217 022 Universale - 87-95 mm

Chiave filtri olio a fascia regolabile

Band wrench for oil filter cartridge



- 217 030 Universale - 65-110 mm
- 217 031 Fascia ricambio

Chiave filtri olio ed essiccati a fascia regolabile

Band wrench for oil filter cartridge and truck dry cartridge



- 217 032 Universale - 100-150 mm
- 217 033 Fascia ricambio

Chiave filtri olio a fascia fibra telata regolabile

Band wrench for oil filter cartridge



- 217 037 Universale - 70-110 mm
- 217 038 Fascia ricambio

Chiave filtri olio a fascia regolabile

Band wrench for oil filter cartridge



- 217 039 Universale - 60-190 mm

Chiave filtro olio a fascia alta, universale, ideale per macchine da lavoro

1/2" Strap wrench



- 217 040

Dati tecnici - Informative

Per filtri fino a mm 180
Attacco quadro di manovra 1/2"

Chiave filtro olio dentata con cinghia in cuoio

Band wrench for oil filter cartridge

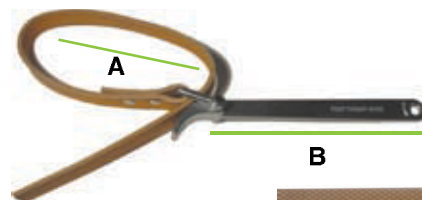

	A	B	C
217 041	Ø 40 - 160	mm 180	mm 20
217 042	Ø 40 - 240	mm 240	mm 25

Ricambi - Spare-parts

- 217 041 01 Cinghia in cuoio per 217 041
- 217 042 01 Cinghia in cuoio per 217 042

Chiave filtri olio a doppia catena sottile

Double Chain wrench for oil filter cartridge



217 051 Universale - 1/4" - 60-120 mm

217 052 Catena di ricambio

Chiave filtri olio a doppia catena sottile

Double Chain wrench for oil filter cartridge



217 053 Universale - catena da 1/4" - 60-120 mm

217 053 01 Universale - catena da 1/4" - 60-160 mm

Ricambi - Spare-parts

217 054 Catena per 217 053

217 054 01 Catena per 217 053 01

Chiave a catena doppia sottile per filtri olio

Oil filter wrench with double chain

Att. 1/2"

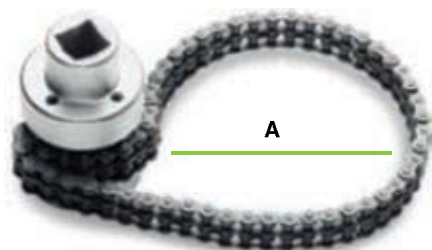

217 053 10 Ø 60 - 120

217 053 11 Ø 60 - 160

Chiave filtri olio a doppia catena

Double Chain wrench for oil filter cartridge



217 055 Universale - 3/8" - 60-120 mm

Ricambi - Spare-parts

217 056 Catena di ricambio 58 passi

Chiave filtri olio a catena regolabile

Chain wrench for oil filter cartridge



217 057 Universale - 1/2 - 60-120 mm

Chiave filtro a catena doppia

Double chain wrench for oil filter



217 058 mm 60 - 160

Ricambi - Spare-parts

217 059 Catena di ricambio 88 passi

Chiave filtri olio a banda e catena

Band and Chain wrench for oil filter cartridge



217 061 Universale - 80-110 mm

Ricambi - Spare-parts

217 061 01 Catena con fascia di ricambio

217 061 02 Fascia ricambio senza catena

217 062 Catena di ricambio senza fascia

Chiave filtri olio a banda e catena con ingranaggio

Band and Chain wrench for oil filter cartridge with gear



217 063 Universale - 1/2" - 80-110 mm

Ricambi - Spare-parts

217 064 Catena di ricambio

Chiave filtri olio a catena con ingranaggio

Chain wrench for oil filter cartridge with gear



- 217 065 Universale - 1/2" - 60-110 mm
- 217 066 Catena di ricambio
- 217 067 Universale - 1/2" - 60-140 mm
- 217 068 Catena di ricambio

Chiave filtri olio a catena regolabile

Chain wrench for oil filter cartridge



- 217 069 Universale - 60-110 mm

Ricambi - Spare-parts

- 217 070 Catena di ricambio

Chiave filtri olio a catena regolabile

Chain wrench for oil filter cartridge



- 217 071 Universale - 60-110 mm

Ricambi - Spare-parts

- 217 072 Catena di ricambio

Chiave filtri olio a doppia catena

Double Chain wrench for oil filter cartridge



- 217 073 Universale - 3/8" - 60-110 mm
- 217 07301 Universale - 3/8" - 60-140 mm

Ricambi - Spare-parts

- 217 074 Cat. ricambio 217 073
- 217 074 01 Cat. ricambio 217 073 01

Chiave a fascia alta resistenza per filtri olio-aria



- 217 078 Ø 105 - 120 Att. 1/2"
- 217 079 Ø 115 - 135 Att. 1/2"
- 217 080 Ø 130 - 145 Att. 1/2"

Chiave filtri olio a leva registrabile

Lever wrench for oil filter cartridge



- 217 085 Universale - 75-92 mm

Chiave filtri olio a pinza

Plier wrench for oil filter cartridge



- 217 087 Universale registrabile - 60-90 mm
- 217 088 Universale registrabile - 85-115 mm

Chiave autoserrante reversibile per filtri olio

Reversible filter wrench



- 217 090 Ø 66 - 83

Chiave filtri olio registrabile

wrench for oil filter cartridge

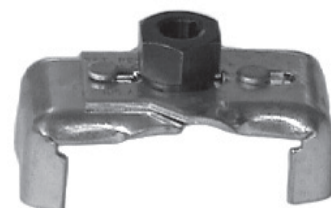

- 217 092 Universale - 85-100 mm

Chiave filtri olio registrabile

Lever wrench for oil filter cartridge



217 093 Universale - 80-105 mm

Chiave filtri olio autoserrante

wrench for oil filter cartridge



217 094 Universale - 60-100 mm

Serie chiavi filtri olio registrabili

Set wrenches auto locking for oil cartridge



217 095 Universale - 60-125 mm - Pz. 3

Ricambi - Spare-parts

217 096 Universale - 60-80 mm

217 097 Universale - 80-100 mm

217 098 Universale - 100-125 mm

Chiave a tre zampe bassa per filtri olio

Three low legs key for oil filter



217 099 Ø 60/99



Chiave filtri olio in lamiera di acciaio ad alta resistenza con quadro 1/2" ed esagono da mm 24

Wrench for oil filter cartridge sheet steel with square 1/2" and exagon 24 mm



217 100 Nissan-Opel-Isuzu-Mazda-Mitsubischi
14 lati - 64 mm

217 102 Mitsubishi - 14 lati - 67 mm

217 104 Fiat - 8 lati - 74 mm

217 106 Mercedes-Bmw - 14 lati - 75 mm

217 107 Fiat Nuova Croma - 16 lati - 75 mm

217 108 Opel - 15 lati - 76 mm

217 110 15 lati - 80 mm

217 112 Fiat - 10 lati - 93 mm

217 116 Fiat - 15 lati - 106 mm

217 118 Fiat -PALIO EXTRASOTTILE
15 lati - 106 mm

Chiave filtri olio in lamiera di acciaio ad alta resistenza con quadro 1/2" ed esagono da mm 24

Wrench for oil filter cartridge sheet steel with square 1/2" and exagon 24 mm



217 120 Twingo-Opel 1500 D - 6 tacche - 66 mm

217 122 Megane - 12 tacche - 76 mm

217 124 Laguna - 18 tacche - 86 mm

217 126 Peugeot - 45 tacche - 92 mm

217 128 Laguna D - 18 tacche - 96 mm

Serie di chiavi filtri olio in acciaio FIAT- JAPAN

Set of wrenches for oil filter cartridge on steel



217 130 Pz 5

Contenuto - contains

217 100 Nissan-Opel-Isuzu-Mazda-Mitsubischi -
Nuova punto - 14 lati - 64 mm

217 102 Mitsubishi - 14 lati - 67 mm

217 104 Fiat - 8 lati - 74 mm

217 112 Fiat Bravo Brava Marea - 10 lati - 93 mm

217 116 Fiat Diesel Iveco - 15 lati - 106 mm

Serie di chiavi filtri olio in acciaio EUROPEE

Set of wrenches for oil filter cartridge on steel



217 132 Pz 5

Contenuto - contains

- 217 106 Mercedes - 14 lati - 75 mm
- 217 108 Opel - 15 lati - 76 mm
- 217 120 Nuova Twingo- Clio Nouvelle - Opel 1.5D
6 tacche - 66 mm
- 217 122 Megane - Clio - 12 tacche - 76 mm
- 217 124 VAG Tdi - Laguna D - 18 tacche - 86 mm

Chiave filtro olio a tazza lamiera acciaio con attacco 3/8"

Lati



Tacche



- 217 135 Mitsubishi - 14 lati - 65-67 mm
- 217 135 01 14 Lati - 68 mm
- 217 135 02 14 Lati - 73 mm
- 217 135 03 Doppio diametro - 15 Lati - 74 / 76 mm
- 217 135 04 14 Lati - 76 mm
- 217 136 30 Tacche - 76 mm
- 217 136 01 Doppio diametro - 15 Lati - 75 / 77 mm
- 217 136 02 Attacco 3/8" - Lati 15 - mm 78
- 217 137 Mitsubishi-Nissan-Suzuky-Toyota ect
15 lati - 80 mm
- 217 138 Opel - 15 lati - 82 mm
- 217 138 01 Attacco 3/8" - Lati 15 - mm 80 - 82
- 217 138 02 Attacco 3/8" - Lati 16 - mm 86
- 217 139 Fiat - 15 lati - 90 mm
- 217 139 01 36 Tacche - 93 mm
- 217 140 Isuzu - 15 lati - 100 mm
- 217 141 15 lati - 93 mm
- 217 142 15 lati - 108 mm
- 217 143 18 lati - 108 mm

Chiave filtro olio a tazza per MAN

Oil filter key



In lega di Alluminio



Esagono mm 27

Quadro 3/8"



217 144 18 Lati - mm 135

Set 15 pz. chiavi filtro olio a tazza

Set of wrenches for oil filter



217 145 in valigetta

- 14Lati Ø65 Dayatsu - Toyota
- 14Lati Ø68 Mazda - Subaru
- 14Lati Ø73 Toyota
- 15Lati Ø74/76 Fram
- 14Lati Ø76 Mercedes - BMW
- 15Lati Ø80 Nissan - Honda
- 15Lati Ø93 VW - Renault
- 36Tacche Ø93 Motorcraft
- 14Lati Ø65/67 USA - CANADA
- 15Lati Ø80/82 Honda - Mazda
- 15Lati Ø90 Isuzu - Mitsubishi
- 15Lati Ø75/77 GM - Ford
- 30Tacche Ø76 Motorcraft
- 15Lati Ø100 Isuzu - Vix - Holder - M3/8 - F1/2

Set chiavi filtro olio a tazza

Set Oil filter cap wrench



217 146 Att. 3/8" & 1/2" - Valigetta Pz 30

Composizione - Composition

mm	N° lati	mm	N° lati	mm	N° lati
66	6	76	30	93	36
65	14	76	8	93	45
66-67	14	78	15	95	15
68	14	80	15	96	18
73	14	80-82	15	100	15
74	15	86	16	106	15
74-76	15	86	18	108	15
75-77	15	90	15	108	18
76	12	92	10		
76	14	93	15		

Adattatore 3/8" - 1/2"

Ragno mm 65-120

Chiave filtri olio in lega leggera PURFLUX con esagono di manovra da mm. 24

Wrench for oil filter cartridge aluminium with exagon 24 mm



217 150	Twingo-Opel 1500 D - 6 tacche 66 mm
217 152	Megane - 12 tacche 76 mm
217 154	Laguna - 18 tacche 86 mm
217 156	Laguna D - 18 tacche 96 mm

Chiave filtro gasolio Peugeot - Citroen HD. 2 - 2.2

Fuel filter socket



mm 27

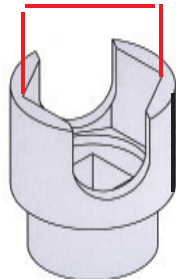

217 167	mm 27
---------	-------

Set chiavi in acciaio per filtri olio ad immersione

Steel set Oil filter cap wrench



217 168	Att. 3/8" - mm: da 24 alla 38 - Pz 7
---------	--------------------------------------

Composizione - Composition

Att. 3/8"	mm 24 - 27 - 29 - 30 - 32 - 36 - 38
-----------	-------------------------------------

Set chiavi per filtri olio ad immersione

Set Oil filter cap wrench



217 170	Att. 3/8" - Pz 3 - in valigetta
---------	---------------------------------

Ricambi - Spare

217 170 01	Att. 3/8" - mm 27
217 170 02	Att. 3/8" - mm 32
217 170 03	Att. 3/8" - mm 36

Chiavi per filtri olio ad immersione

Set Oil filter cap wrench



217 170 24	Att. 3/8"	mm 24
217 170 27	Att. 3/8"	mm 27
217 170 30	Att. 3/8"	mm 30
217 170 32	Att. 3/8"	mm 32
217 170 36	Att. 3/8"	mm 36
217 170 38	Att. 3/8"	mm 38

Chiave filtro olio ricavata da tondo pieno

Acciaio Cromato



217 172	Fiat - 8 lati - 74 mm
217 176	Fiat - 10 Lati - 92 mm
217 178	TRUCK - 15 Lati - 106 mm

Chiave filtro olio in acciaio saldato con quadro 1 / 2" ed esagono di manovra mm 24

Oil filter wrench solder steel - 1 / 2"



Zincate



217 180	14 Lati - mm 64
217 184	Fiat - 08 Lati - mm 74
217 185	10 Lati - mm 74
217 186	Mercedes-Bmw - 14 Lati - mm 75
217 186 01	Multijet 1.9 - 16 Lati - mm 75
217 187	Opel - 15 Lati - mm 76
217 187 06	14 Lati - mm 80
217 188	Mitsu..-Niss..-Suz..-Toy - 15 Lati - mm 80
217 188 00	16 Lati - mm 87
217 188 01	12 Lati - mm 88
217 188 02	16 Lati - mm 90
217 188 03	16 Lati - mm 92
217 188 05	10 Lati - mm 90
217 188 08	15 Lati - mm 90
217 188 14	14 Lati - mm 84
217 189	Fiat Marea TD - 10 Lati - mm 93
217 190	Volvo - 15 Lati - mm 93
217 190 05	15 Lati - mm 98 -
217 191	Iveco - 15 Lati - mm 106
217 192	Isuzu - 16 Lati - mm 118
217 193	18 Lati - mm 136
217 196	9 Tacche mm 92
217 197	9 Tacche mm 95

Chiave filtro olio "MODELLO ALTO" in acciaio saldato con quadro 1/2" ed esagono di manovra mm 24



217 189 01 10 Lati - 93 mm

Chiave filtro olio in acciaio saldato

Oil filter wrench solder steel

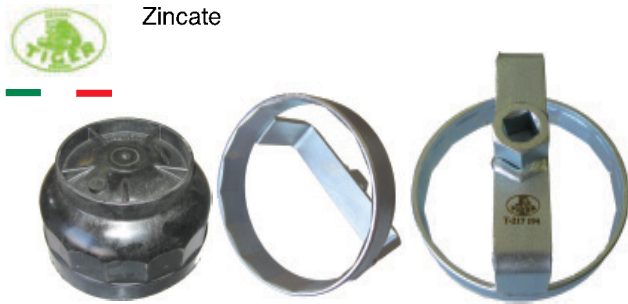

217 194 Iveco - Eurocargo

Dati tecnici - Informative

Lati 15 - mm 112,5
Attacco quadro di manovra 1/2"
Esagono di manovra mm 24

Chiave filtri olio a fascia

Band wrench for oil filter cartridge



217 200 Universale - 75 mm

217 201 Universale - 80 mm

217 202 Universale - 98 mm

217 203 Universale - 110mm

217 204 Universale - 140mm

Chiave filtri olio in acciaio

Steel wrench for oil filter cartridge



217 210 Renault Laguna TD - 18 tacche - 108 mm

Chiave filtri olio a tacca con quadro 1/2"

Wrench for oil filter cartridge



217 215

Chiave filtro olio VESPA PIAGGIO 50 CC

Band wrench for oil filter cartridge VESPA PIAGGIO 50 CC



217 220 Quadro manovra 1/2"

Chiave filtri olio TDCI Ford - HDI Citroen - Peugeot

Oil filter wrench on TDCI Ford - HDI Citroen - Peugeot



217 240 Att. 1/2" Poligono mm. 27

Dati tecnici - Informative

Chiave per smontare e rimontare il filtro dell'olio montati sui motori 2.0 Duratorq TDCI (HDI DW10C) e 2.2 TDCI Duratorq TDCI (HDI DW 12C) su veicoli Ford - Jaguar - Land rover e motori HDI Citroen - Peugeot.

Set 3 Pezzi per lo smontaggio in morsa del filtro gasolio multijet Fiat e Opel

Set for disassembly multijet filter Fiat & Opel

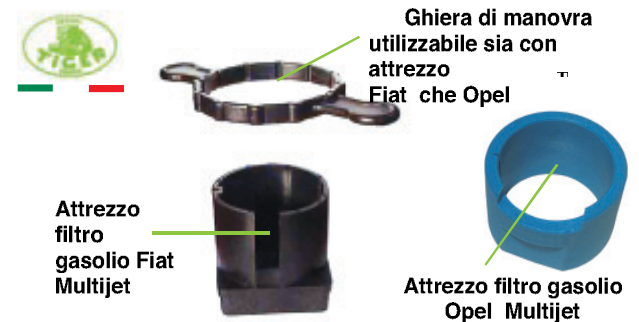

217 245 Ghiera + Attrezzo Fiat - Kit 2 Pz

217 245 10 Ghiera + Attrezzo Fiat + Attrezzo Opel - kit 3 Pz

Ricambi - Spare

217 245 01 Ghiera di manovra

217 244 Attrezzo filtro gasolio Opel Multijet

Chiave filtro gasolio vetture Peugeot HDI



217 246

Chiave smontaggio filtri olio e gasolio alta in lega di alluminio pressofusa



217 249 Ø 74 - 14 Lati

Chiave aperta per filtro gasolio strumentato

Key for fuel filters



217 250 H=120mm 14 lati - mm75

Chiave filtro a campana pesante



	Attacco	Lati	mm	Altezza
217 251	1/2"	15	141	50

Chiave filtro olio alta per Toyota

Alluminio



217 252 14 Lati con 1 tacca mm 64,5

Dati tecnici - Informativi

-Toyota: 207 - 2008 3.5L V6
 -Lexus: GS300 (2006), IS250 (2006), IS350 /2006), ES350 (2007) GS350 (2007), GS450 (2007), LS460 (2007), RX350 (2007) LS600h L(2000)

Chiave filtro olio a tazza in alluminio

Wrench for oil filter cup type



217 253 14 Lati con 3 tacche + 3 tacche mm 64,5 Att.3/8"

Toyota 2007 - 2008 V6 / Dal 2006 tutte le Lexus / Dal 2007 ES350 - GS350 - GS450h - LS460 - RX350 / Dal 2008 LS600hI

Chiave filtro olio a tazza in alluminio per HYUNDAI & KIA

Wrench for oil filter cup type
100 mm

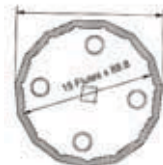

217 254 15 Lati mm 88,8 Att.3/8"

Chiave per manovra bulbo acqua

Wrench for water bulb removal



217 391 29 mm

Chiave ghiere fissaggio filtro olio

Wrench for oil filter nut fixing



217 392 Alfa 155-164 6 denti 34x24x3.5 4 denti 34x26x5

Chiave ghiere fissaggio filtro olio

Wrench for oil filter nut fixing



217 393 Alfa 164 - Polig 22 mm

Chiave ghiere fissaggio filtro olio

Wrench for oil filter nut fixing



217 394 Audi-Polo - 38,5 x 18 x 7

Chiave ghiere fissaggio filtro olio

Wrench for oil filter nut fixing



217 395 164 TD

Kit riparazione filetto tappo coppe olio

Kit repairing oil filter cups



217 400 12 Tappi con rondelle

Ricambi - Spare

	Esagono	Esagono femmina	Filetto	Pz
217 400 01	17	-----	13 x 1,5	1
217 400 03	19	-----	15 x 1,5	1
217 400 05	---	8	17 x 1,5	1
217 400 07	---	10	20 x 1,5	1

Kit in astuccio riparazione filetto tappo coppe olio

Kit repairing oil filter cups



- 217 400 13 1 maschio + 12 rondelle + 6 tappi - 13 x 1.5
- 217 400 15 1 maschio + 12 rondelle + 6 tappi - 15 x 1.5
- 217 400 17 1 maschio + 12 rondelle + 6 tappi - 17 x 1.5
- 217 400 20 1 maschio + 12 rondelle + 6 tappi - 20 x 1.5
- 217 400 22 1 maschio + 12 rondelle + 6 tappi - 22 x 1.5

Kit universale riparazione filetto tappo coppe olio

Oil pan repair master set



217 401

Composizione - Composition

1 maschio + 10 rondelle + 5 tappi	13 x 1.5
1 maschio + 10 rondelle + 5 tappi	15 x 1.5
1 maschio + 10 rondelle + 5 tappi	17 x 1.5
1 maschio + 10 rondelle + 5 tappi	20 x 1.5

Chiave tappo olio monolitica per Audi

Oil cup socket hole XZN
Acc. Cr Mo.
Cromato



Att.
1/2"



mm 55

M 16



217 404 XZN 16 Forata

Bussola con inserto xzn forato per dadi coppa olio

Socket with bit hole xzn for oil cup



217 405 Audi - 16 x 55

217 406 Audi - 16 x 100

Chiave dadi tappo olio

Wrench for oil draining plug



217 412 Fiat - 12 mm

Chiave dadi tappo olio

Wrench for oil draining plug



217 413 Fiat - 12 mm

Chiave quadra dadi tappo olio

Wrench square for oil draining plug



217 415 Ford - 11-12 mm

Chiave dadi tappo olio

Wrench for oil draining plug



- 217 416 Quadro 8 mm
- 217 416 01 Quadro 9 mm
- 217 417 Quadro 10 mm

Chiave dadi tappo olio sezione triangolare

Wrench for threangle oil draining plug



- 217 418 Triangolare 10 mm

Chiave dadi tappo olio con doppio quadro

Double wrench for oil draining plug



- 217 420 Quadro 8-9 mm
- 217 421 Quadro 8-10 mm

Chiave dadi tappo olio con doppio esagono

Double wrench for oil draining plug



- 217 423 Audi-Volkswagen 14-17 mm

Chiave doppia dadi tappo olio e cambio

Twin wrench for oil draining plug and gear



- 217 425 M 10 mm - F 10 mm
- 217 426 M 8 mm - F 6 mm

Set chiavi tappi olio

Set of oil draining plug wrenches



- 217 430 Quadro 8-3/8"-10-11-13
Esagono 5/16"-8-10-3/8"-12-14





Set chiavi tappi olio

Set oil draining plug wrenches



- 217 431 Att 1/2" - Pz 21

Composizione - Composition

-  mm6 - 7 - 8 - 10 - 11 - 12 - 13 - 14 - 5/16 - 3/8"
-  mm 8 - 9 - 10 - 12 - 13 - 14 - 17
-  Tx10 - Tx45  mm16
-  Quadro femmina mm10 - 1 asta con quadro 1/2"

Chiave quadra dadi tappo olio

Tank opener



- 217 440 Universale

Imbuti per travaso olio motore Fire (compatibili con prolunga)

Wrench for lambda sensor (mm 22)



- 217 441 Imbuto circolare corto per taniche da 1 litro
- 217 442 Imbuto quadrato corto per taniche da 4 litri
- 217 441 01 Imbuto circolare lungo per taniche da 1 litro
- 217 442 01 Imbuto quadrato lungo per taniche da 4 litri

Prolunghe filettate (compatibili con prolunga)



- 217 443 Prolunga filettata per imbuti Fire
- 217 444 Prolunga filettata per imbuti Fire su vetture Multijet
- 217 447 Prolunga filettata per Multiair e EVO 2

Prolunga flessibile per imbuti travaso olio motore Fire da utilizzare su furgoni e vetture Multijet con tappo olio in profondità



- 217 446 Lunghezza mm 470

Prolunga flessibile + Prolunga filettata per motori Multiair



- 217 447 01 Lunghezza mm 510

Imbuto olio lt. 2.2 con sistema anti-reflusso

Made in Germany



- 217 445 Motori Audi - Seat - Skoda - Vw - Etc

Kit astine controllo olio trasmissione motori

Mercedes transmission oil dipstick set



- 217 454 Pz 4

Ricambi - Spare-parts

- 217 450 Per cambi tipo: 722.6 - mm 1220
- 217 451 Per cambi tipo: 722.7 / 716.5 - mm 920
- 217 452 Per cambi tipo: 103-943 / 984 / 985-104-111-119-120-137-603-913 / 963 / 97-604-605-606-611-612-613-626 - mm 930
- 217 453 Per cambi tipo: 112-113-646-647-648 - mm 930

Asta rilevamento livello olio Audi A4 & A5

Audi transmission oil dipstick Audi A4 & A5



- 217 459 NB: La misurazione deve essere effettuata con una temperatura dell'olio di circa 60°

Astina controllo olio cambio Audi 100

Audi 100 oil dipstick

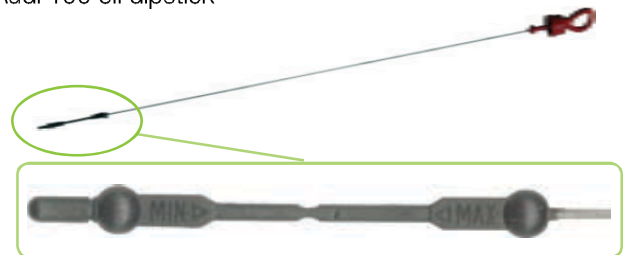

- 217 460 L= mm 520

Chiave per lo smontaggio sonda temperatura su motori Freemont 2.0 - 140cv Mg



- 217 485

Kit riparazione filetti sonda lamda



217 490 M18x1.5

Chiave per sonda lambda

Wrench for lambda sensor

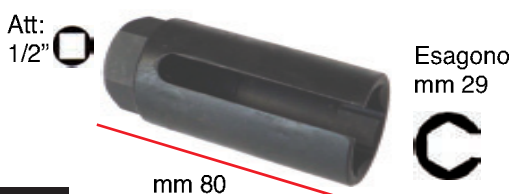

1/2"

217 493 Esagono mm 29

Chiave bussola snodata, aperta, doppia impronta, con impugnatura piegata

Angled socket 22 mm hex



Impronta Poligonale mm 22

Impronta Esagonale mm 22

217 495 Per sonda lambda - mm 22 x 250

Chiave sonda lambda pesante con doppio quadro di manovra

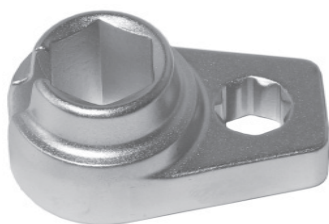

217 496 1/2" - 22 mm

Kit bussole per sonda lambda (mm 22)

Wrench for lambda sensor (mm 22)



217 497 Pz 5

Composizione - Composition

	Attacco quadro	Lunghezza	Esagono
1°	1/2"	mm 150	mm 22
2°	1/2"	mm 80	mm 22
3°	1/2"	mm 48	mm 22
4°	3/8"	mm 30	mm 22
5°	Ravviva Filetti M 18 x 1,5		

Chiave manovra sonda lambda con doppio quadro

Wrench for dismantling Lambda sensor



217 498 1/2" - 22 mm

217 503 3/8" - 22 mm

Chiave poligonale manovra sonda Lambda

Wrench for dismantling Lambda sensor

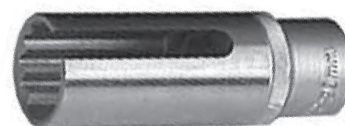

217 499 Corta 1/2" - 20x78 mm

Chiave manovra sonda Lambda

Wrench for dismantling Lambda sensor



217 500 Corta 3/8" - 22x80 mm

217 501 Corta 1/2" - 22x80 mm

217 502 Lunga 1/2" - 22x120 mm

Chiave per sonda lambda extralunga - Impact

Wrench for dismantling lambda sensor - Impact

Acciaio Cr. M



217 502 15

mm 150

Chiave manovra sonda lambda con doppio quadro

Wrench for dismantling Lambda sensor



217 498 1/2" - 22 mm

217 503 3/8 - 22 mm

Chiave poligonale manovra sonda Lambda

Wrench for dismantling Lambda sensor



217 504 20 mm

Attrezzo per smontaggio molle ritegno tubo di scarico

Tool for removing spring of manifold and muffler pipe



217 505 Golf-Passat

Tagliamarmitte regolabile per tubi di scarico

Cutter for muffler pipe
in esaurimento



217 507 Universale - 19-76 mm

Ricambi - Spare parts

217 508 Catena

Utensile allargatubi marmitte catalitiche

Tool for pipe muffler opening

Utilizzare avvitatore
per espansione



217 509 Universale - 41-62 mm

Utensile allargatubi marmitte

Tool for pipe muffler opening



217 511 Universale - 22-40 mm

217 513 Universale - 38-62 mm

217 515 Universale - 54-84 mm

Ricambi - Spare parts

217 512 Segmento - 217 511

217 514 Segmento - 217 513

217 516 Segmento - 217 515

217 517 Perno completo - 217 511

217 518 Perno completo - 217 513

217 519 Perno completo - 217 515

Attrezzo per lo stacco dei tubi di scarico

Tool off pipes



217 525 in valigetta

Chiave a gancio per gommini sostegno tubi scappamento

Wrench for holding muffler pipe rubbers



217 529 Volkswagen-Audi-Mercedes-Nissan-Fiat-Opel

Chiave a gancio corta per gommini sostegno tubi scappamento

Wrench for holding muffler pipe rubbers



217 530 Volkswagen-Audi-Mercedes-Nissan-Fiat-Opel

Chiave a gancio corta per gommini sostegno tubi scappamento

Wrench for holding muffler pipe rubbers



217 531 Ford-Bmw

Kit per smontaggio / montaggio catene

Chain cutter & riveting tool suitable

Smontaggio Montaggio



218 000

Dati tecnici - Informative

*Il kit è indicato lo smontaggio / montaggio catene delle moto, ma si rende praticamente adatto a tutti i tipi di catene essendo dotato di 3 perni intercambiabili di diverso diametro

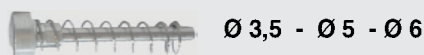

Ø 3,5 - Ø 5 - Ø 6

Attrezzo smonta / monta catene

Disassembling / assembling chains tool



700 180

Dati tecnici - Informative

Con viti a puntale e viti a punta conica per allargare il piolo forato
Il set è composto di punzone rivettatore per catene RIF: 415 - 420 - 428 - 520 - 525 - 530 - 532

Attrezzo smonta / monta catene di distribuzione

Disassembling / assembling chains tool



700 185

Attrezzo centrafrizione universale

Universal tool for centering clutch



221 001 Universale

Attrezzo centrafrizione universale

Universal tool for centering clutch



221 005 Universale

Ricambi - Spare parts

221 006 Perno Piccolo

221 007 Perno Medio

221 008 Perno Grande

Attrezzo centrafrizione universale

Universal tool for centering clutch



221 010 Universale

Attrezzo montaggio seeger reggispinta frizione

Tool for seeger clutch



221 031 VALEO

Estrattore volano frizione

Puller for clutch



221 032 Innocenti Mini

Molle per montaggio gruppo frizione

Springs for refitting clutch



221 040 Opel Kadett-Astra

Chiave poligonale per dado fissaggio albero primario cambio Ford Transit

Key for trasmission gearbox Ford transit

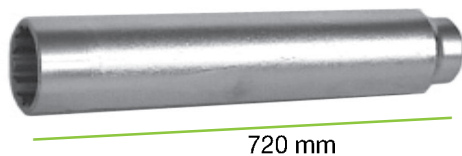

720 mm

221 045 Att. 3/4 - 46 mm

Set montaggio frizione Luck e Sac

Self adjusting clutch tool set (3 hole pitch)



221 048 in scatola
Completo di 3 serie di perni per renderlo adatto a quasi tutti i veicoli;
Audi-Bmw-Mercedes-Opel-Renault-Volvo- Vw- ecc...

Ricambi - Spare parts

221 04901
Ø6



221 04902
Ø7



221 04903
Ø8



221 049 01 Set 3 perni Ø6

221 049 02 Set 3 perni Ø7

221 049 03 Set 3 perni Ø8

Set montaggio frizione Luck e Sac

Self adjusting clutch tool set (3 hole pitch)



221 04901
Ø6



221 04902
Ø7



221 04903
Ø8



221 049 Completo di 3 serie di perni per renderlo adatto a quasi tutti i veicoli; Audi-Bmw-Mercedes-Opel-Renault-Volvo- Vw- ecc...

Ricambi - Spare parts

221 049 01 Set 3 perni Ø6

221 049 02 Set 3 perni Ø7

221 049 03 Set 3 perni Ø8

Kit per montaggio frizioni Sac - Luk (3 / 4 fori)

Self adjustin clutch tool set (3 And 4 hole pitch)



221 050 Kit in valigetta
Adatto a quasi tutti i veicoli; Audi-Bmw-Mercedes-Opel-Renault-Volvo-Vw ecc... Per alcuni veicoli che montano frizioni a 4 fori tipo Mercedes classe A, il kit comprende anche l'attrezzo a 4 staffe con i suoi relativi perni.

Estrattore volano frizione

Puller for clutch



221 051 Peugeot

Estrattore volano frizione

Puller for clutch



221 052 Peugeot 404

Minipinza per seeger senza fori per accessi difficili

Mini-plier for seeger without holes



221 054 50 mm

Pinza anelli elastici senza fori su cuscinetti giunti omocinetici e cambio beccuccio piegato

Plier for ring without hole



221 055 Fiat-Iveco Fuller

Pinza anelli elastici senza fori montati su giunti omocinetici e cuscinetti cambio. Becchi diritti

NUOVO MODELLO



mm 215

221 055 01 Fiat-Iveco Fuller

Pinza anelli elastici senza fori su cuscinetti giunti omocinetici e cambio beccuccio diritto



221 056 Fiat - Iveco fuller

Pinza anelli elastici senza fori su cuscinetti giunti omocinetici e cambio beccuccio piegato



221 057 Fiat - Iveco fuller

Pinza per anelli elastici senza fori in acciaio forgiato manici plastificati

Plier for elastic rings without holes



221 058 Punta rette - 220 mm

Pinza per anelli elastici senza fori in acciaio forgiato manici plastificati

Plier for elastic rings without holes



221 059 Punta angolate - 220 mm

Estrattore perno frizione DUCATO 2.8 JTD

Joint clutch puller for DUCATO 2.8 JTD



221 060 L=120mm

Attrezzo estrazione cuscinetto spingidisco per frizione Ducato

Joint clutch puller - Ducato



221 070

Attrezzo per montaggio anelli elastici di ritegno sincronizzatori albero secondario

Tool for compressing washers for replacing circlips on gearbox mainshaft



222 001 Fiat 131-Aregnta-Campagnola

222 002 Fiat 128-Ritmo-127 1050-Delta

Attrezzo per montaggio anelli elastici di ritegno sincronizzatori albero secondario

Tool for compressing washers for replacing circlips on gearbox mainshaft



222 003 Fiat 127-Uno 45/55

222 004 Fiat 131-132-Campagnola

222 005 Fiat Panda 45

Estrattore leva comando marce

Gearbox lever



222 006 Alfa Sud-33-33 4x4

Attrezzo ritengo innesto 2° velocità durante la misurazione pignone corona

Tool for stopping 2° gear for measuring

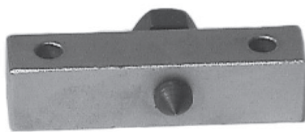

222 010 N 500

Spessore registro posizione leva comando cambio di velocità

Tool for adjusting position of gear lever



222 011 N 500

Chiave per registro marce

Wrench for adjusting gear march



222 012 Golf

Calibro per leva cambio

Caliper for gear lever



222 013 Golf 5 Marce

Chiave ghiera alberi cambio

Wrench for gear shaft nut



222 014 Ulisse - Ducato - Scudo - 44x41x5

Chiave ghiera fissaggio albero cambio

Wrench for gear shaft nut



222 015 Ducato

Chiave ghiera fissaggio albero cambio

Wrench for gear shaft nut

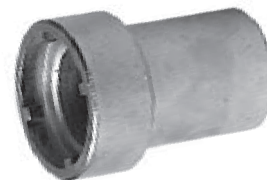

222 017 Daily - diam. 40 mm

222 018 Daily - diam. 44 mm

222 019 Daily - 48 x 42 x 5

Chiave per dado albero primario

Wrench for gear main shaft nut



222 020 Alfetta - 30 mm

Chiave manovra dado pignone conico albero secondario

Spanner for bevel pinion layshaft retaining nut

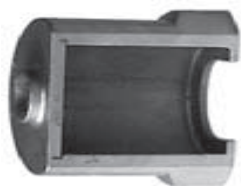

222 021 Fiat 242 - 36 mm

Chiave ghiera cuscinetto semiscatola albero secondario

Wrench for half gearbox bearing nut

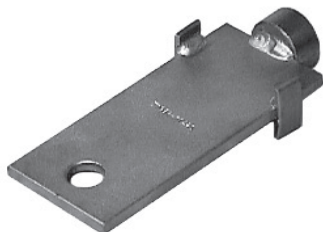

222 022 Fiat 242

Chiave ghiera cuscinetto semicalotta esterna riduttore

Wrench for auxiliary bearing nut



222 023 Fiat 242

Chiave ghiera albero riduttore

Wrench for low Pto ring nut



222 024 Fiat 242 - 44 mm

Estrattore ingranaggio del cambio 5° marcia su motori Ford

5°Gear extractor Ford engine



222 030

Coppia attrezzo smontaggio boccole comando cambio

Wrench for auxiliary bearing nut



222 200 Alfa - Citroen - Fiat - Lancia - Peugeot - Toyota

Attrezzo ad espansione per smontare anello di ritegno assale

Tool for dismounting retaining axle ring



223 001 GM-FWD-Daily

Battitoio montaggio cuscinetto stagno su semialbero

Device for refitting bear ring on half shaft



223 002 N 500

Chiave a ghiera per smontaggio differenziale della Fiat Panda 4 x 4

Wrench for dismounting Fiat Panda differential



Att. 1/2"

	Ø Est	Ø Int	Dente	Att.
223 003	51	45	h7 x 5 x spess.3	1/2"
223 00301	55	47	h7 x 5 x spess.4	1/2"

Battitoio montaggio cuscinetto stagno su semialbero

Device for refitting bear ring on half shaft



223 004

223 005



223 004 Diam. Est. 34 mm - Diam. Int. 30 mm

223 005 Diam. Est. 34 mm - Diam. Int. 28 mm

Chiave lunga per differenziale VW - AUDI

XZN tool for shuft nut



- 223 006 01 XZN mm 08x800
- 223 007 XZN mm 10x500
- 223 007 01 XZN mm 10x800

Chiave esagonale maschio

Wrench male for nuts



- 223 011 8x500 mm

Set chiavi XZN Corte e Lunghe con innovativo attacco

Duo-Drive

- M 18 x 40
- M 16 x 40
- M 14 x 40



Att. 1/2"



Hex mm 24

- M 18 x 60
- M 16 x 60
- M 14 x 60

- 223 013 01 Valigetta Pz 6

Set chiavi XZN Corte e Lunghe con innovativo attacco

Duo-Drive

- Made in Germany 
- M 12 x 60
 - M 14 x 60
 - M 16 x 60
 - M 18 x 60



- M 12 x 40
- M 14 x 40
- M 16 x 40
- M 18 x 40



Att. hex mm 24



Att. 1/2"

- 223 014 Valigetta Pz 8

Chiave a bussola con maschio XZN per mozzi VW e Audi, e per coperchio scatola differenziale Audi A3 - Vw Touran

XZN tool for shuft nut



Att. 1/2"

Acciaio Cr. Molibdeno



mm 78

- 223 015 Att. 1/2" tipo impact - M 18x78
- 223 016 Att. 1/2" tipo impact - M 16x75

Chiave a bussola con maschio XZN per mozzi VW e Audi, e per coperchio scatola differenziale Audi A3 - Vw Touran

XZN tool for shuft nut



Acciaio Cr. Molibdeno



Att. 3/4"



M18

mm 70

- 223 015 02 Att. 3/4" - Tipo impact - M 18 x 70

Chiave per ghiera a 4 denti rimozione ghiera flangia albero trasmissione Mercedes e AR



- 223 018 Att. 1/2" - 40x35x7,5

Chiave ghiera bloccaggio mozzo giunto differenziale

Spanner to lock inboard constant velocity pinion flange ring nut



- 223 019 Panda 4x4 interna 42x35x55
- 223 020 Lancia Beta - 44 x 35 x 6

Chiave ghiera flangia cambio al pignone

Wrench for shaft nut to pinion



- 223 021 Mercedes transporter - 43 x 36 x 8
- 223 022 Mercedes - 43 x 36 x 5
- 223 024 Mercedes - 34 x 25 x 8

Chiave ghiera bloccaggio mozzo giunto differenziale

Spanner to lock inboard constant velocity pinion flange ring nut



223 029 R4-R5

Chiave ghiera bloccaggio mozzo giunto differenziale

Spanner to lock inboard constant velocity pinion flange ring nut



223 030 R 12-R16-R17-R18-Fuego-R5 Alpine

Chiave ghiera bloccaggio flangia di trascinamento giunto omocinetico

Spanner to lock inboard constant velocity



223 031 Beta-Gamma - 63 x 45 x 8

Chiave ghiera bloccaggio flangia sede giunto scorrevole lato propulsore

Spanner for coupling flangering nut, engine side



223 032 Lancia Flavia-Fulvia - 61 x 51 x 7

Chiave ghiera registrazione cuscinetto differenziale

Spanner for adjusting differential nut



223 033 Fiat 126

223 034 Panda 30

Attrezzo trascinamento corona differenziale per controllo coppia di rotolamento e gioco di accoppiamento pignone corona

Tool for drag differential gear for checking bearing rolling torque and clearance between pinion and gear



223 036 Panda 30

Chiave ghiera ritegno cuscinetti scatola esterna differenziale

Wrench for extern ball bearing box retaining nut



223 037 Panda 30 Nuova 500 - 54 mm

Chiave ghiera cuscinetti semiassse intermedio

Wrench for internal axle differential



223 042 ALFA 155 - 43 x 35 x 6.

Fermo dado pignone differenziale

ool retainig nut differential pinion



223 045 Alfa Giulia

Chiave per ghiera cuscinetto e ingranaggio contachilometri albero differenziale

Puller of speedometer pinion and nut



223 047 Alfa Sud

Estrattore introduttore albero giunto omocinetico

Introducer for half shaft constant velocity joint



223 051 Alfa 33-155

Pinza per seeger senza fori giunti omocinetic

Pliers for seeger omocinetic joint

Chrom Vanadium
Made in Germany

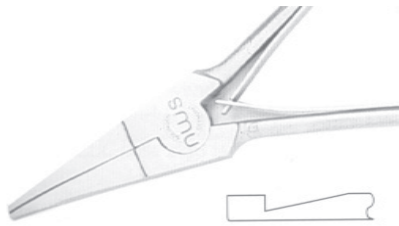

223 052 01 mm 170

Set 3 pinze anelli senza foro su giunto omocinetic

Set 3 plier for circlips without hole for half shaft



Becco dritto

Becco 30°

Becco 60°



223 052 10 Pz 3

Pinza fascette cuffie giunti omocineticinetic

Plier for circlips joint



223 053 Fiat 127-127-Ritmo 65/70-Uno

223 054 Alfa 164

223 055 Uno-Turbo-Regata 100s-Croma-Punto

223 056 Thema

Forcella a leva per estrazione semiassi

Rubber for axle



223 058 Nuova Punto

223 060 Ducato

Cono per introduzione cuffie su semiasse

Installer for rubber on axle



223 061 Citroen AX-Visa - 56 mm

223 062 Renault-Citroen - 58 mm

223 063 Twingo-R9-R11-R5 Super - 67 mm

223 064 R21-R25-Trafic - 70 mm

223 065 Peugeot 205 - 79 mm

223 066 Citroen BX-CX-405-505 - 92 mm

Cono per introduzione cuffie su semiasse

Installer for rubber on axle



223 070 Citroen AX-Visa-Citroen-Renault 23 - 102 mm

Attrezzo pneumatico universale per montaggio cuffie

Universal pneumatic tool for mounting rubber seals

BOOTSLIDER



223 090 Press. max 8 bar per cuffie orig. "BOOGE" 2.5 Kg

Cono per inserimento cuffie elastiche

Cone for mounting rubber on axle



223 103 Universale

Cuffia universale per giunti omocinetic con kit di montaggio

Universal kit seal with cone



223 104 **Composizione:** 1 Cono - 1 Cuffia - 2 fascette - 1 Grasso

Kit cuffia elastica universale con grasso e fascette



223 105 con fascette e grasso

Attrezzo serraggio fascette a nastro



223 109 Per fascette mm 5 e mm 8

Attrezzo per fascette a nastro

Tool for circlips



223 110

Attrezzo per fascette a nastro

Tool for circlips



223 111

Rotolo fascette per serraggio cuffie. Custodia in plastica-fermagli



- 223 112 01 Rotolo con custodia - mm 5x50 mt
- 223 113 01 Rotolo con custodia - mm 8x25 mt
- 223 114 01 Custodia vuota - Per 223 112 e 223 113
- 223 115 Sacchetto Fermagli - mm 5 100 pz.
- 223 116 Sacchetto Fermagli - mm 8 100 pz.

Kit fascette a rotolo per giunti omocinetic

Set band for trasmission



- 223 120 1 Rotolo fascetta mm 5 x mt 50 in astuccio + 100 Fermagli mm 5 + 1 Pinza
- 223 121 1 Rotolo fascetta mm 8 x mt 25 in astuccio + 100 fermagli mm 5 + 100 fermagli mm 8 + 1 Pinza + 1 Rotolo fascetta mm 5 x mt 50 in astuccio

Ricambi - Spare-parts

- 223 111 Pinza per fascette a nastro
- 223 112 01 Rotolo con astuccio mm 5 x mt 50
- 223 113 01 Rotolo con astuccio mm 8 x mt 25
- 223 114 01 Astuccio vuoto x rotoli mm 5 / mm 8
- 223 115 Confezione 100 fermagli mm 5
- 223 116 Confezione 100 fermagli mm 8

Avendo rinnovata la linea di produzione dei rotoli fascette per serraggio cuffie giunti omocinetic, a partire dai futuri ordini i rotoli fascette saranno forniti esclusivamente con la relativa custodia. Questo agevolerà il lavoro degli operatori, i quali non avranno più problemi di srotolamento della fascetta a operazione conclusa. NB: Al primo uso la protezione posta sulla custodia andrà tolta, per la successiva operazione basterà piegare il terminale del rotolo.

- Prezzi inalterati
- Vogliate gentilmente rilevare la nuova codifica

Attrezzo inserimento corteco differenziale cambio F17 su nuova Croma e Alfa 15

Tool for differential clutch F17 on Croma & Alfa 159



223 125

Chiave ghiera differenziale cambio F17 su nuova Croma e Alfa 159

Wrench for differential clutch F17 on Croma & Alfa 159



223 130

Introduttore cuscinetto differenziale per Alfa 159 1.9 JTD 8V/16V, motore Alfa 1858 bz e 2.2 DDI, Fiat nuova Croma 8V/16V JTD

Introducer for bearing differential



223 135

Coppia perni stacco gruppo airbag su volante Fiat

Doblò - Fiorino - Nuova Punto - Qcubo - Idea



230 000

Set estrattore Air bag Vw

Air-bag removal tool Vw



231 000

Per: Polo - Lupo / New Beetle / Seat / Skoda Fabia - Octavia - Bora AB Bj 1999 / Golf 4 Bj 1998-2004 / Passat B5 - Passat Ab Bj 1997-2000 / Bmw - Mercedes (Nuovi modelli)

Estrattore volante di guida

Steering wheel puller



231 001 Opel

Estrattore volante di guida

Steering wheel puller



231 002 Alfa universale - 8x1.25 6x1

Kit 2 estrattori corto e lungo per volante con air-bag



231 004 In valigetta

Chiave a bussola con inserto Torx Forato per Airbag VW - Audi

Wrench socket Torx with hole for Air-bag



mm 300

231 004 30 30 x 300 - Att. 1/2"

Estrattore volante di guida

Steering wheel puller

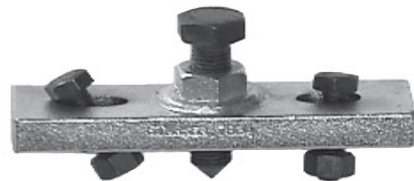

231 006 Suzuky SJ410-Carry

Estrattore volante di guida

Steering wheel puller



231 007 Mini Minor

NOTE



Attrezzo a rulli autoserranti interni di nuova esecuzione per montaggio / smontaggio braccetti sterzo

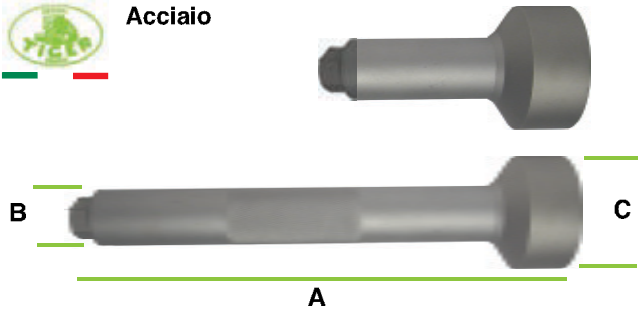

	Serraggio	A	B	C
231 008	Ø 35 - 45	mm 400	Ø 45	Ø 90
231 008 01	Ø 35 - 45	mm 195	Ø 45	Ø 90
231 008 05	Ø 28 - 35	mm 400	Ø 45	Ø 72
231 008 06	Ø 45 - 50	mm 400	Ø 40	Ø 88
231 008 08	Specifico per Daily		New	

Attrezzo rimozione braccetto sterzo

Puller for steering arms



231 009 Foro Ø 20 - Manovra 1/2"

Chiave ghiera servosterzo

Wrench steering slave nut



231 010 Mercedes 190 - 60x54x8

Chiave per tensionare cinghia servosterzo

Wrench for nut pulley of steering slave



231 011 Alfa Romeo - 13 mm

Livella telescopica per regolazione volante guida

Extension level for steering wheel regulation



231 015

Chiave 10 punti femmina per rimozione viti di fissaggio bracci posteriori su Honda CR-V

10 Point impact socket-20mm size: 1/2"DR

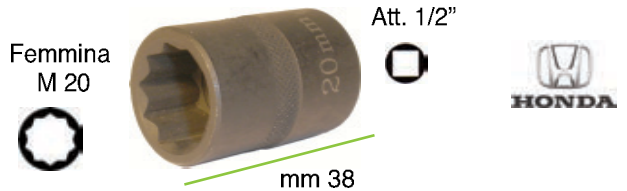

231 020 L = mm 38 - M20

Attrezzo rotazione alberi

Tool for rotation steering arms



231 100 3/8 - 36 mm

231 101 3/8 - 41 mm

Chiave rotazione alberi

Excentric clamp for turning/fixing ball joint

Made in Germany 



231 102 Inserimento (A) mm 50

Chiave rotazione alberi

Multi-purpose inner tie rod tool

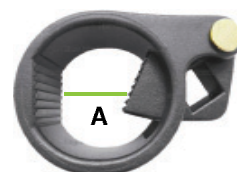

231 103 Apertura Max (A) mm 42

231 107 Apertura Max (A) mm 40 - 47

Chiave smontaggio-serraggio braccetti mozzi

Acciaio temprato -
Brunito

Made
in
Germany

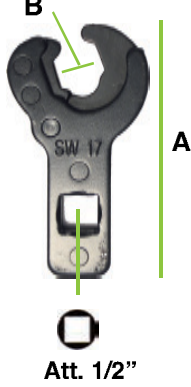
	A	B	Att.	
231 113	90	13	1/2"	Vw
231 114	90	14	1/2"	Audi
231 117	90	17	1/2"	Opel

Chiave smontaggio-serraggio braccetti mozzi

Made
in
Germany



231 120	mm 12-13	231 122	mm 21-22
231 121	mm 19-20		

Estrattore introduttore cuscinetto mozzo posteriore

Introducer ball bearing rear puller



232 004 Alfetta-164

Battitoio smontaggio mozzo anteriore

Introducer of front hubs



232 005 127-128-Ritmo-Panda A112

Perni per estrazione mozzo per art. 221 032

Pins for hubs for item 221 012



232 007 IM3.

Battitoio smontaggio mozzo anteriore

Puller of front hubs



232 008 Alfa sud

Battitoio montaggio mozzo anteriore

Introducer of front hubs



232 009 Alfa sud

Estrattore universale per mozzi auto e furgoni con interasse viti o prigionieri max Ø120 mm



232 010 Vite con filetto a sezione trapezoidale

Vite idraulica



232 010 11 8 Ton

Note: vite idraulica di grande portata utilizzabile su nostro articolo codice 232 010 solo su richiesta.

Kit estrattore universale per furgoni in pratica valigia metallica

Universal tool for hubs



232 010 50 Piastra - Vite - 3 serie di colonnette M/F Pz17

*Il Kit viene fornito con 3 serie di colonnette:
 232 01055 Maschio Ø 16 x 1.5 / Femmina Ø 14 x 1.5 Pz 5
 232 01056 Maschio Ø 16 x 1.5 / Femmina Ø 16 x 1.5 Pz 5
 232 01057 Maschio Ø 16 x 1.5 / Femmina Ø 18 x 1.5 Pz 5
 in alternativa e senza sovrapprezzo possiamo fornirli con le tre serie di colonnette Maschio - Maschio su vostra indicazione

Ricambi - Spare-parts



232 010 51 Piastra



232 010 52 Vite



232 010 55 M Ø 16 x 1.5 / F Ø 14 x 1.5 - Pz 5
232 010 56 M Ø 16 x 1.5 / F Ø 16 x 1.5 - Pz 5
232 010 57 M Ø 16 x 1.5 / F Ø 18 x 1.5 - Pz 5

Adattatori opzionali - Optional adaptor



232 010 54 M Ø 16 x 1.5 / F Ø 12 x 1.5 - Pz 5



232 010 60 F Ø 16 x 1.5 / F Ø 14 x 1.5 - Pz 5
232 010 61 F Ø 16 x 1.5 / F Ø 16 x 1.5 - Pz 5
232 010 62 F Ø 16 x 1.5 / F Ø 18 x 1.5 - Pz 5



232 010 63 M Ø 16 x 1.5 / M Ø 12 x 1.25 - Pz 5
232 010 64 M Ø 16 x 1.5 / M Ø 12 x 1.75 - Pz 5
232 010 65 M Ø 16 x 1.5 / M Ø 14 x 1.5 - Pz 5
232 010 66 M Ø 16 x 1.5 / M Ø 16 x 1.5 - Pz 5
232 010 67 M Ø 16 x 1.5 / M Ø 18 x 1.5 - Pz 5



232 01070 Maschio / Maschio per: Ford transit - Pz 5

NOTE





www.afasupport.it

**Kit di spinta per estrazione flangia montante Ford
In comoda valigetta metallica**



232 010 80 Piastra + 3 colonnette + 5 Perni + 5 Perni - Pz14

Utilizzabile solo in abbinamento con nostro Kit 232 010 50

Ricambi - Spare-parts

F14 x 2  M16 x 1.5

232 010 81 Pz 3

 M16x2

232 010 82 Pz 5

Spina Ø8  M 10 x 1,5

232 010 83 Pz 5

Adattatori opzionali - Optional adaptor

Spina Ø9  M16 x 2

232 010 84 Pz 5

Utilizzo - Using

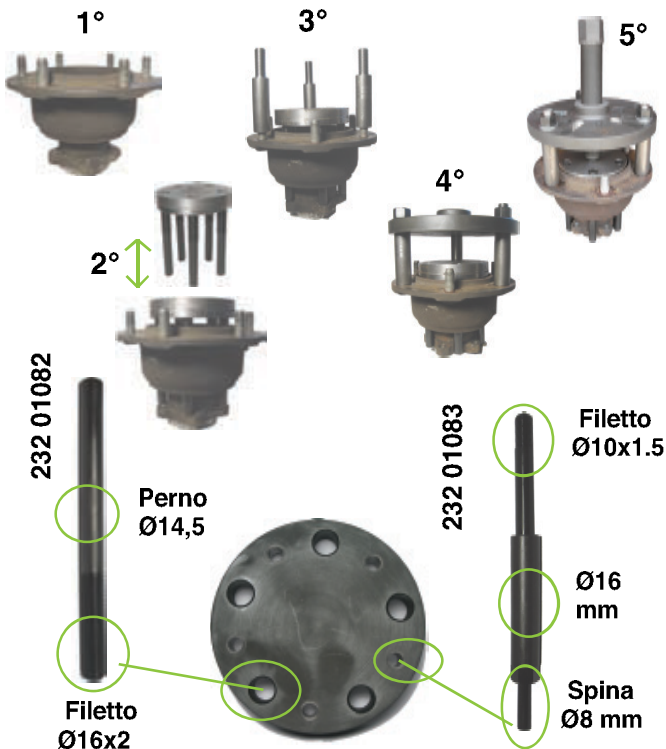

Estrattore smontaggio mozzo anteriore e posteriore

Puller of front hubs



232 011 Citroen GS - ant. - 84x1,5

232 012 Citroen GS - Post. - 75x1.5

Estrattore smontaggio mozzo posteriore

Puller of front hubs

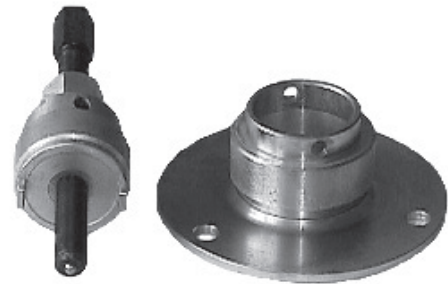

232 013 Citroen Diane-GS-Ami.

Estrattore smontaggio mozzo posteriore

Puller of front hubs



232 014 Citroen Diane-2Cv

Estrattore smontaggio mozzo posteriore

Puller of front hubs



232 016 Alfetta Giulia - Da usare 235 102

Chiave per ghiera regolazione cuscinetto mozzo posteriore vetture Fiat Idea & Lancia Musa

Tool bag on fiber



Att.
1/2"



Poligono



1/2"

232 018 Att. 1/2" - Poligonale mm 31

Chiavi impact per ghiera mozzi



Att.
3/4"



Poligono



3/4"

Chiave impact per ghiera mozzo posteriore
vetture Fiat Idea & Lancia Musa

232 018 31 Att. 3/4" Poligonale mm 31

Chiave conica per ghiera mozzi anteriori

232 019 Att. 3/4" Poligonale mm 36

Chiave per ghiera mozzo posteriore

232 027 Att. 3/4" Poligonale mm 44

Chiave impact per mozzo Volkswagen

232 033 Att. 3/4" Poligonale mm 33

Chiave impact per mozzo Volkswagen

232 037 Att. 3/4" Poligonale mm 37

Chiave impact per mozzo Volkswagen

232 039P Att. 3/4" Poligonale mm 39

Chiave per mozzi Ducato

232 045P Att. 3/42 Poligonale mm 45

Chiave per mozzi Ducato (nuovi modelli)

232 055P Att. 3/4" Poligonale mm 55

Chiavi coniche impact per ghiera mozzi

Att.
3/4"



Esagono



3/4"

Chiave conica per ghiera mozzo anteriore

232 020 Att. 3/4" Esagono mm 36

Chiave conica per ghiera mozzo fiat Ducato

232 024 Att. 3/4" Esagono mm 41

Chiave conica per ghiera mozzo anteriore Daily

232 025 Att. 3/4" Esagono mm 42

Chiave conica per ghiera mozzo Ducato 2.4

232 028 Att. 3/4" Esagono mm 46

Estrattore per mozzi posteriori con ruote gemellate Iveco Daily



232 023 Vite 36 x 2 x 200 per ozzi da 8 e 9 fori

Chiave conica impact per ghiera mozzo MG

Tool bag on fiber

Att.
3/4"



Ottagono



3/4"

232 026 Att. 3/4" - Ottagono mm 50

Set 5 pz. chiavi per ghiera mozzi e differenziali

5 pcs. drive tooth socket



232 030 Att. 1/2"

Ricambi - Spare parts

232 030 01 Ghiera Mercedes Ø42x35 - 4 denti da 6mm

232 030 02 Ghiera Mercedes Ø42x35 - 4 denti da 8mm

232 030 03 Ghiera Mercedes Ø43x35 - 4 denti conici da 6mm

232 03004 Ghiera Mercedes Ø46x38 - 4 denti conici da 6mm

232 070 Ghiera Mercedes Ø55x50 - Perno Ø27 -
4 denti da 8mm

Chiave per ghiera mozzi " 4 denti"

Drive 4 tooth socket



Att.
1/2"



Dente

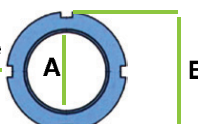

	Att.	Dente	A interno	B esterno
232 031	1/2"	mm 6	mm 30	mm 35

Chiave ghiera mozzo posteriore ruota singola

Wrench for rear hubs nut single weel



232 035 Transit - 64 x 50 x 6

Chiave ghiera mozzo posteriore ruote gemellari

Wrench for rear hubs nut twin weels



232 036 Transit - 67 x 57 x 6

Chiave a bussola esagonale per mozzi Scooter

Exagonal wrench for scooter hubs

Yamaha



232 039 mm 39 - Att. 3/4"

Chiave ghiera mozzo anteriore

Wrench for front hubs nut

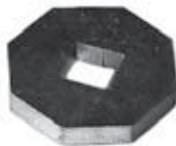

232 040	127 DAN-Fiorino-Uno Diesel	48 mm
232 041	127 1050-128-	45-52 mm
232 042	127 1050-128-	52 mm
232 043	Alfa 33 u.t.	65 mm
232 044	Alfa 33 u.t. economica	65 mm
232 045	Alfa 33 -arna-164	68 mm
232 046	Alfa 33 -arna-164 economica	68 mm

Chiave ghiera mozzo anteriore

Wrench for front hubs nut



232 050 Nissan Vanette

Chiave ghiera mozzo anteriore

Wrench for front hubs nut



232 051 Alfa sud - 55 mm

Chiave ghiera mozzo anteriore e posteriore

Wrench for front and rear hubs nut



232 055 Lancia Beta - 65 x 58 x8
232 056 Lancia Gamma - 81 x 72 x 8

Chiave ghiera mozzo anteriore

Wrench for front hubs nut

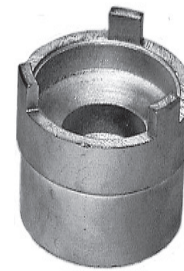

232 059 Lancia Flavia-Fulvia u.t. - 50x40x8

Chiave ghiera mozzo anteriore

Wrench for front hubs nut



232 060 Lancia Flavia-Fulvia u.t. - 94 x 82 x 8

Chiave ghiera mozzo anteriore

Wrench for front hubs nut



232 063 Lancia Flavia-Fulvia - 53 x 44 x 6

Chiave ghiera esterna mozzo posteriore

Wrench for external rear hubs nut



232 065 62 x 53 x 12

Chiave a ghiera a 6 denti per Porter Piaggio

Wrench for Piaggio Porter

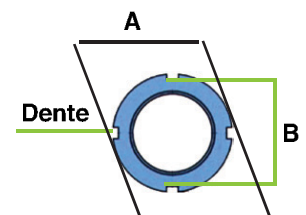

	Att.	A-esterno	B-interno	Dente
232 065 01	1/2"	mm 62	mm 57	mm 7

Chiave ghiera interna mozzo posteriore

Wrench for internal rear hubs nut



232 066 Lancia Flavia-Fulvia u.t. - 62 x 56 x 7

Chiave ghiera esterna mozzo posteriore

Wrench for external rear hubs nut



232 067 Lancia Flavia-Fulvia u.t. - 71 x 62 x 7

Chiave ghiera interna mozzo posteriore

Wrench for internal rear hubs nut



232 068 Lancia Flavia-Fulvia - 71 x 68 x 7

Chiave ghiera esterna mozzo posteriore

Wrench for external rear hubs nut



232 069 Lancia Flavia-Fulvia - 82 x 73 x 7

Chiave ghiera per mozzi posteriori Mercedes Benz mod. 107-114-115-116-126

Wrench for posterior hubs

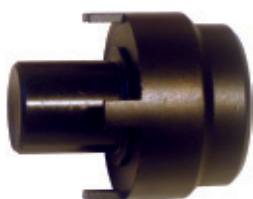

232 070 Att. 1/2" - 4 Denti - Ø55x50x8 - Perno Ø 22

Chiave ghiera mozzo posteriore

Wrench for rear hubs nut



232 072 Alfa 75-164 - 70 x 61 x 7

Chiave ghiera mozzo posteriore

Wrench for external rear hubs nut



232 074 Alfetta - 66 x 59 x 7

Chiave ghiera mozzo posteriore

Wrench for external rear hubs nut



232 075 Regata-Duna weekend - 64 x 56 x 8

Chiave ghiera mozzo posteriore

Wrench for external rear hubs nut



232 078 Tipo - 18 mm

232 079 Tempra - 19 mm

Chiave ghiera mozzo posteriore

Wrench for external rear hubs nut



232 080 Polo-Golf - 1/2" - P 30 mm

Chiave dado mozzo posteriore

Wrench for rear hubs nut



232 082 Tipo - 32 mm

Set bussole e maschi impact per ghiera e mozzi

Set impact wrench for hubs nut



232 083 Pz 8 - Att. 1/2"

Composizione - Composition

- 414 529 30 Bussola poligonale lunga - mm 30 x 85 - Att 1/2"
- 414 529 32 Bussola poligonale lunga - mm 32 x 85 - Att. 1/2"
- 414 529 34 Bussola poligonale lunga - mm 34 x 85 - Att. 1/2"
- 414 529 35 Bussola poligonale lunga - mm 35 x 85 - Att. 1/2"
- 414 529 36 Bussola poligonale lunga - mm 36 x 85 - Att. 1/2" -
- Maschi esagonali Pz 3 - mm 14 - 17 - 19 - Att. 1/2"

Chiave ghiera semiassi

Wrench for internal axle



232 084 Simca 1100-1307-1308 - 67 x 61 x 8

Chiave ghiera mozzo posteriore

Wrench for and front hubs nut



232 086 Citroen GS - 83 x 70 x 7

Set pad pulizia incrostazioni da mozzi e cerchi

Wheel hub grinder

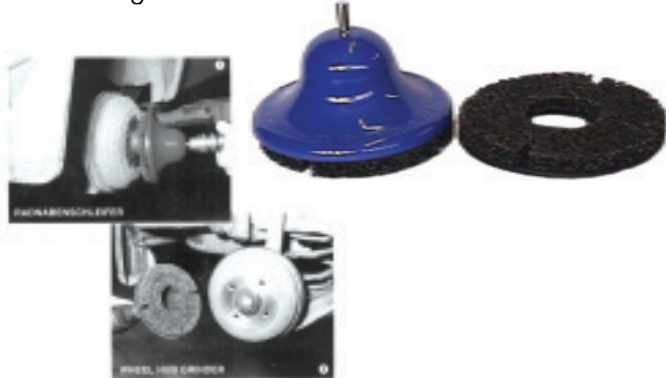

232 090 Campana Ø 150 + 3 Pad

Ricambi - Spare-parts

232 091 Pad singolo

Set pulizia base prigionieri su mozzi ruote

Wheel hub grinder

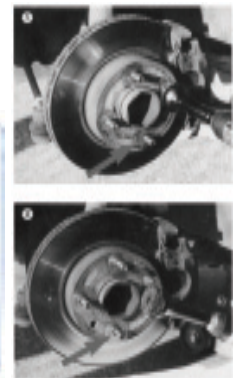

232 092 Campana Ø45 + 6 Pad / Campana Ø55 - 6 Pad

Ricambi - Spare-parts

- 232 093 Pad Ricambio Ø55
- 232 094 Pad Ricambio Ø45

Set pulizia base prigionieri su mozzi ruote

Wheel hub grinder

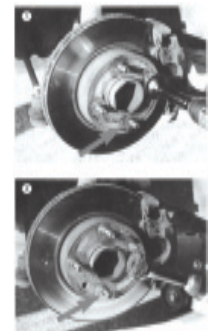

232 092 00

Composizione - Composition

- 1 Campana Ø 45 con 6 pad
- 1 Campana Ø 55 con 6 pad
- 1 Adattatore att. 1/2"

Ricambi - Spare-parts

- 232 093 Pad Ø55 (singolo)
- 232 094 Pad Ø45 (singolo)

Set pad di pulizia mozzi per furgoni RPM 1000max

Wheel hub grinder



232 096 1 Campana + 2 Pad Ø200

Ricambi - Spare-parts

232 097 Pad Ricambio - Ø200

Kit bussole estrazione prigionieri ruote veicoli

Kit extraction imprisoned car wheels



232 100 Valigetta completa - Pz. 6

Ricambi - Spare-parts

- 232 100 00 Bussola 10 mm
- 232 100 01 Bussola 12 mm
- 232 100 02 Bussola 14 mm
- 232 100 03 Bussola 17 mm
- 232 100 04 Bussola 19 mm
- 232 100 05 Bussola 21 mm.

Kit bussole con filetto passo sinistro per estrazione prigionieri rovinati ruote veicoli

Damaged nuts remover kit



232 101 Att 1/2" - Pz 7

Ricambi - Spare-parts

- 232 101 01 Bussola 1/2" - mm 17
- 232 101 02 Bussola 1/2" - mm 18,5
- 232 101 03 Bussola 1/2" - mm 20
- 232 101 04 Bussola 1/2" - mm 21,5
- 232 101 05 Bussola 1/2" - mm 23
- 232 101 06 Bussola 1/2" - mm 24,5
- 232 101 07 Bussola 1/2" - mm 26

Kit estrazione dadi rovinati

Damaged nuts remover kit



Dis.
elicoidale



1/4"

1/2"

232 104 In valigetta Pz.15

Composizione - Composition

Attacco 1/4" - mm 6, 8, 10, 11, 12
 Attacco 1/2" - mm 13, 14, 15, 17, 19, 21, 24, 27
 Asta Ø 6 lunga mm 70
 Asta Ø 12 lunga mm 80

Ricambi - Spare-parts

- 232 104 17 Bussola 1/2" mm 17
- 232 104 19 Bussola 1/2" mm 19
- 232 104 21 Bussola 1/2" mm 21
- 232 104 24 Bussola 1/2" mm 24
- 232 104 27 Bussola 1/2" mm 27

Set 9 pz. bussole svita dadi rovinati



232 105 mm 10-11-12-13-14-15-16-17-19 - Att 1/2"

Kit bussole lunghe con espulsore per dadi rovinati

Twist socket set

Acciaio Cr.
Molibdeno
Brunito



mm 150

232 106 Pz 3 - mm 17-19-21 - Att 1/2"

Set 7 Pz. distanziali per estrazione cuscinetti mozzi utilizzabili con pressa

Set 7 Pcs outdistance them for extraction usable cut-off pads with press



232 110 Valigetta completa - 7 pz.

Ricambi - Spare-parts

- 232 110 01 Dist. per cusc. Renault
- 232 110 02 Dist. per cusc. Peugeot 106
- 232 110 03 Dist. per cusc. Fiat-WV Golf-Opel Corsa/Astra
- 232 110 04 Dist. per cusc. Citroen
- 232 110 05 Dist. per cusc. Peugeot 205
- 232 110 06 Dist. per mozzo Fiat-WV-Opel-Peug-Alfa-Lancia
- 232 110 07 Dist. per mozzo Ford-Peugeot-Fuoristrada
- 232 110 08 Dist. per Mozzo. Renault Traffic
- 232 110 09 Dist. per cusc. Renault Traffic.

Set 3 Pz. distanziali per estrazione cuscinetti mozzi utilizzabili con pressa

Set 3 Pzes. outdistance them for extraction usable cut-off pads with press



232 112 Valigetta completa

Ricambi - Spare-parts

- 232 112 01 Dist. per cusc. Renault Laguna
- 232 112 02 Dist. per cusc. Peugeot 206
- 232 112 03 Dist. per cusc. VW Golf IV-Audi A3

Set Perno con rondelle per estrazione ed inserimento cuscinetti mozzo

Kit for hubs nut



232 114

Kit estrazione mozzi guida Bmw

Puller for drive shafts



232 115

Composizione - Composition

- M 16 x 1,5 - per Subaru
- M 20 x 1,5 - per Vw Beetle - Touareg - Porsche Cayenne
- M 22 x 1,5 - per Bmw E 30 - E 46
- M 24 x 1,5 - per Bmw E36 - Mercedes W203
- M 27 x 1,5 - per Bmw E32 - E34 - E38 - E39 - X5
- M 30 x 1,5 - per Bmw E32 - E34 - E36

Attrezzo universale per estrazione dei cuscinetti mozzi con l'utilizzo della pressa



Brevetto depositato



Per vederne l'utilizzo tramite filmato clicca:
WWW.AFASUPPORT.IT
CLICCA: AGGIUNTA 2007
CLICCA: 232 120

- 232 120 Attrezzo in Alluminio lucido (in valigetta)
- 232 120 20 Attrezzo in alluminio Anodizzato (in valigetta)

Ricambi - Spare-parts

- 232 120 01 Perno corto per piastra traslante
- 232 120 02 Coppia pemi corti + rondelle + bulloni per prigionieri
- 232 120 03 Coppia pemi medi + rondelle + bulloni per prigionieri
- 232 120 04 Bullone con rondella per blocco piastra traslante

Attrezzo universale per estrazione dei cuscinetti mozzi dei veicoli commerciali con l'utilizzo della pressa

Tool bag on fiber



Brevetto depositato

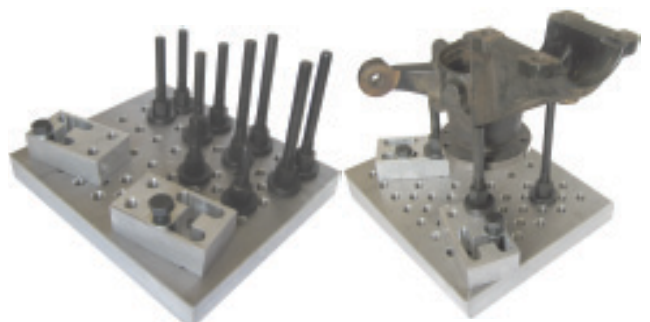

- 232 120 50 Attrezzo in Alluminio lucido (in valigetta)

Attrezzo estrazione piste cuscinetti

Universal tool for extraction ruller and ball bearing



Per vederne l'utilizzo
tramite filmato clicca:
WWW.AFASUPPORT.IT
Clicca: Novità
Clicca: Simo 232 121

Brevetto depositato

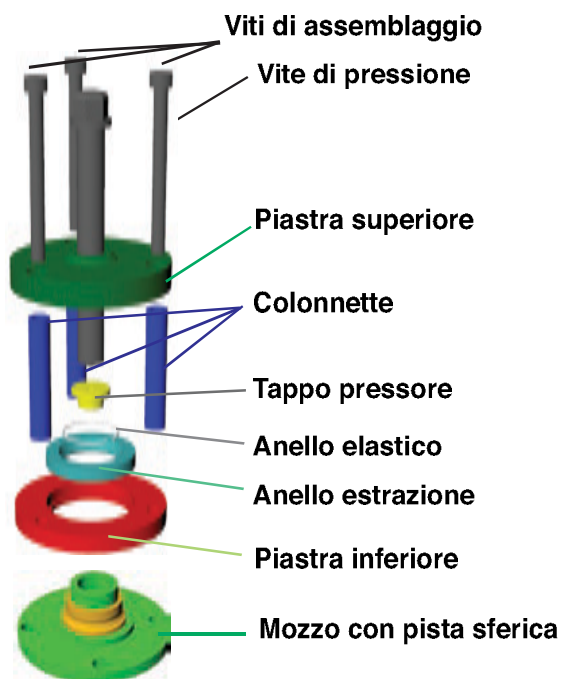

Attrezzo per estrarre in pochi minuti ed in sicurezza, tutte le piste dei cuscinetti:

- A sfere (con o senza cava di schermatura)
- A rulli conici

Grazie alla dotazione di 7 anelli di estrazione di diverso diametro, ognuno dotato di 3 anelli elastici di uguale diametro ma di spessori corda diversi: Ø1,5 - 2 - 2,5 - Simo oltre che di semplice utilizzo, si rende Universale

Risolve un problema annoso per interventi di sostituzione dei cuscinetti sui mozzi

232 121 Kit in comoda valigetta termosoffiata.
Attrezzo + 1 Tappo pressore + 9 anelli di estrazione + 24 anelli elastici

Anello estrattore

	Ø Esterno	Ø Interno	Spessore
232 121 01	mm 70	mm 38	mm 11 + N° 3 anelli elastici Ø1,5 / Ø2 / Ø2,5
232 121 02	mm 70	mm 42	mm 11 + N° 3 anelli elastici Ø1,5 / Ø2 / Ø2,5
232 121 03	mm 70	mm 45	mm 11 + N° 3 anelli elastici Ø1,5 / Ø2 / Ø2,5
232 121 04	mm 70	mm 47	mm 11 + N° 3 anelli elastici Ø1,5 / Ø2 / Ø2,5
232 121 05	mm 70	mm 49	mm 11 + N° 3 anelli elastici Ø1,5 / Ø2 / Ø2,5
232 121 06	mm 70	mm 52	mm 11 + N° 3 anelli elastici Ø1,5 / Ø2 / Ø2,5
232 121 07	mm 70	mm 54	mm 11 + N° 3 anelli elastici Ø1,5 / Ø2 / Ø2,5
232 121 08	mm 70	mm 57	mm 11 + N° 3 anelli elastici Ø1,5 / Ø2 / Ø2,5
232 121 10			Per mozzo Vw Golf IV serie con ruota fonica + N° 3 anelli elastici Ø1,5 / Ø2 / Ø2,5

Cuffia riparo per montanti ruota

Per lavorare senza sporcarsi e senza respirare polveri tossiche



232 125

Attrezzo universale per estrazione giunti omocineticici dai semiassi



232 130 In Valigetta

Attrezzo divaricatore per testine sterzo e supporti ammortizzatori, dotato di due cunei separatori intercambiabili

Universal steering knuckle spreader tool

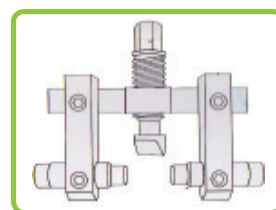

232 135

Attrezzo divaricatore per supporti ammortizzatori e giunti sferici singoli o doppi tipo Audi e Volkswagen

Universal steering knuckle spreader tool



Utilizzo con doppio perno



Utilizzo con singolo perno

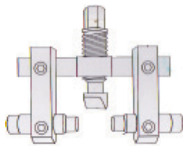

232 136 In valigetta

Chiave dado fissaggio ruota a croce

Wrench for weels nuts

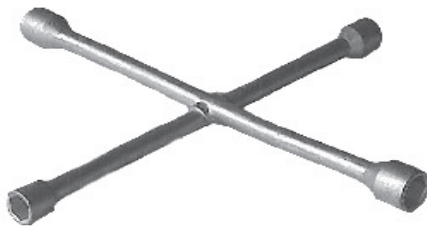

233 011 17-19-21-22 mm

233 012 17-19-22 mm 1/2"

Chiave a croce per ruote autocarri leggeri

Cross key for wheels trucks



233 015 24 x 27x 30 x 3/4

Set chiavi plastificate per bulloni cerchi in lega

Key set plasticized for bolts rims in league



233 019 17-19-21-13/16

Set 3pz. chiavi con protezione in plastica per cerchi ruote in lega

Plastified wrenches for weels nuts



233 020 17 - 19 - 21

233 021 17 - 19 - 22

Chiave plastificata per cerchi in lega

Key plasticized for you look for in league

233 022 mm 17

233 023 mm 19

233 024 mm 21

233 025 mm 22

233 026 mm 23

233 027 mm 14

233 029 13/16"



Set 3 bussole lunghe per bulloni ruote in lega dei fuoristrda

Tool bag on fiber



233 030 l mm 150 mm 17 - 19 - 21

Set 3 pezzi chiavi dinamometriche a bussola

Set 3 Pcs dynamometric wrench

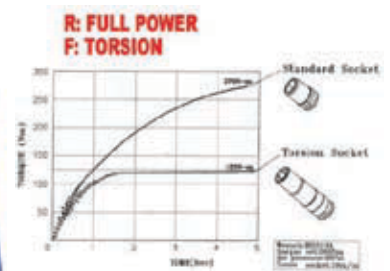

233 032 serraggio max 10 Kgm - mm 17-19-21

Da utilizzare con avvitatore, per il serraggio rapido dei dadi ruote senza correre il rischio di uno strappo finale. E' consigliabile un controllo finale con chiave dinamometrica

Bussole dinamometriche

233 034 Set 5 pz.

U.S.A.

Ricambi - Spare-parts

- 233 036 Kgm 11 mm 17
- 233 037 Kgm 9 mm 19
- 233 038 Kgm 11 mm 19
- 233 039 Kgm 11 mm 21
- 233 040 Kgm 7,5 mm 19



Set chiavi dinamometriche dado fissaggio ruota con quadro maschio 1/2" per bussole a macchina

Dinamometric wrenches for weels nuts



233 050 9-10-11-12-13.5-15-16-17.5-19-20 Kg.m - 1/2"

Chiave dinamometrica dado fissaggio ruota con quadro maschio da 1/2"

Dinametric wrench for weels nuts

1/2"



	Colore	Kg.m
233 051	Verde	9.0
233 052	Nero	10
233 053	Giallo	11
233 054	Rosso	12
233 055	Blu	13
233 056	Arancio	15

Chiave dinamometrica impact per Truck

Impact dynamometric wrench for truck



Acciaio Cr. Molibdeno -
Brunito

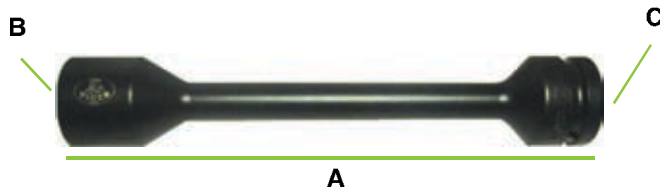

	A	B	C
233 070	mm 305 x mm 27	Att.1"	Kgm 45
233 071	mm 305 x mm 30	Att.1"	Kgm 55
233 072	mm 305 x mm 32	Att.1"	Kgm 60
233 073	mm 305 x mm 33	Att.1"	Kgm 65
233 074	mm 305 x mm 34	Att.1"	Kgm 65
233 075	mm 315 x mm 36	Att.1"	Kgm 65

Pinza per contrappesi cerchi ruota auto

Wheel weight balance plier



233 090

Pinza per piombi ruote con molla

Wheel weight balance plier



mm 230



233 092

Attrezzo per la posa e la rimozione dei pesi a molla separata

Clip fitting tool



233 094 Apertura: 15,5mm e 19mm

Attrezzo speciale per la posa sicura e veloce dei pesi a molla separata

The compression tool



233 095 Apertura max: 335mm

Attrezzo misurazione inclinazione ruote ant. auto

Tool for checking wheel inclination



233 100 Universale - mm 500

233 101 Fuoristrada SUV - mm 800

Attrezzo misurazione convergenza ruote ant.

Tool for checking wheel convergens



233 102 Universale

Livella magnetica rilevazione angolo campanatura; range $\pm 5^\circ$ con incrementi di 0.5°



233 110

Livella magnetica con testa snodata rilevazione angolo campanatura; range $\pm 5^\circ$ con incrementi di 0.5°



233 111

Set 2 pz livella fissa e snodata rilevazione angolo campanatura; range $\pm 5^\circ$ con incrementi di 0.5°



233 112

Divaricatore per regolazione angolo di campanatura con due corpi esagonali

Double tool for registration of incidence of front weels



233 210 VW Golf Polo

Contrappesi in Zinco plasticati per equilibratura ruote vetture

Zinco

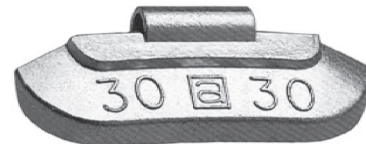

233 300	Standard	pz. 100	gr. 05
233 301	Standard	pz. 100	gr. 10
233 302	Standard	pz. 100	gr. 15
233 303	Standard	pz. 100	gr. 20
233 304	Standard	pz. 100	gr. 25
233 305	Standard	pz. 100	gr. 30
233 306	Standard	pz. 50	gr. 35
233 307	Standard	pz. 50	gr. 40
233 308	Standard	pz. 50	gr. 45
233 309	Standard	pz. 50	gr. 50

Contrappesi in Zinco plasticati per equilibratura ruote vetture

Zinco

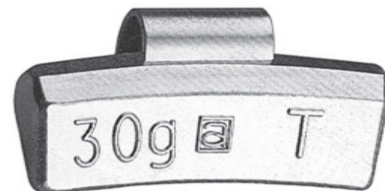

233 320	Cerchi in lega	pz. 100	gr. 05
233 321	Cerchi in lega	pz. 100	gr. 10
233 322	Cerchi in lega	pz. 100	gr. 15
233 323	Cerchi in lega	pz. 100	gr. 20
233 324	Cerchi in lega	pz. 100	gr. 25
233 325	Cerchi in lega	pz. 100	gr. 30
233 326	Cerchi in lega	pz. 50	gr. 35
233 327	Cerchi in lega	pz. 50	gr. 40
233 328	Cerchi in lega	pz. 50	gr. 45
233 329	Cerchi in lega	pz. 50	gr. 50

NOTE



Pesi in Zinco modello "HOFMANN Type 161" per equilibratura cerchi in ferro

Type 161 with integral clip



233 350	Gr. 5	100 pz.
233 351	Gr. 10	100 pz.
233 352	Gr. 15	100 pz.
233 353	Gr. 20	100 pz.
233 354	Gr. 25	100 pz.
233 355	Gr. 30	100 pz.
233 356	Gr. 35	50 pz.
233 357	Gr. 40	50 pz.
233 358	Gr. 45	50 pz.
233 359	Gr. 50	50 pz.
233 360	Gr. 55	50 pz.
233 361	Gr. 60	50 pz.

Pesi in Zinco modello "HOFMANN Type 666" per equilibratura cerchi in lega

Type 666 with integral clip



233 370	Gr. 5	100 pz.
233 371	Gr. 10	100 pz.
233 372	Gr. 15	100 pz.
233 373	Gr. 20	100 pz.
233 374	Gr. 25	100 pz.
233 375	Gr. 30	100 pz.
233 376	Gr. 35	50 pz.
233 377	Gr. 40	50 pz.
233 378	Gr. 45	50 pz.
233 379	Gr. 50	50 pz.
233 380	Gr. 55	50 pz.
233 381	Gr. 60	50 pz.

Contrappesi adesivi tipo "Slim" in Ferro

Ferro

12x5



4x5 - 4x10



233 396	12 x 5	Gr. 60	Pz 100
233 396 01	4 x 5 - 4 x 10	Gr. 60	Pz 100

Rotolo contrappesi in ferro per auto



233 398 1.000 segmenti da 5 gr. - (5 kg)

Dati tecnici - Informative

Applicazioni su tutti i cerchi in lega leggera
Facile da staccare e da applicare
Larghezza: 19mm x Altezza: 3,5mm (incl.nastro adesivo)

Adattatori opzionali - Optional adaptor



233 399 Porta-rotolo (Venduto vuoto)

Multifunzionale per il montaggio al banco oppure alla parete.
Pratico metro sul lato esterno con dispositivo di taglio integrato per poter operare in modo rapido e pratico

"Speedliner Hofmann" Contrappesi slim

Type 380 Zinc adhesive weight for cars

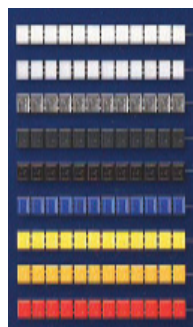

1 striscia = 12pesi da 5gr.



233 400	Grigio	25 strisce
233 401	Nero	25 strisce
233 402	Cromato	25 strisce
233 403	Antracite	6 strisce
233 404	Bianco	6 strisce
233 405	Blu	6 strisce
233 406	Giallo	6 strisce
233 407	Arancio	6 strisce
233 408	Rosso	6 strisce

Dati tecnici - Informative

H3,8mm x 19mm
Innovativo nastro adesivo brevettato, oltre che essere più forte e veloce da applicare è comodissimo da rimuovere poichè non lascia traccia / residui del suo passaggio.
Inoltre le barrette sono legate tra di loro per seguire meglio la curvatura di qualsiasi cerchio
Forte resistenza alla corrosione

Contrappesi adesivi "Hofmann" in zinco per cerchi in lega

Type 390 Zinc adhesive weight for cars



233 410	Gr. 5	100 pz.
233 411	Gr. 10	100 pz.
233 412	Gr. 15	100 pz.
233 413	Gr. 20	100 pz.
233 414	Gr. 25	100 pz.
233 415	Gr. 30	100 pz.
233 416	Gr. 35	50 pz.
233 417	Gr. 40	50 pz.
233 418	Gr. 45	50 pz.
233 419	Gr. 50	50 pz.
233 420	Gr. 55	50 pz.
233 421	Gr. 60	50 pz.

Tutte le altre tipologie di pesi "Hofmann" sono disponibili solo a richiesta



Valvole tubless SHRADER

Tubless valve

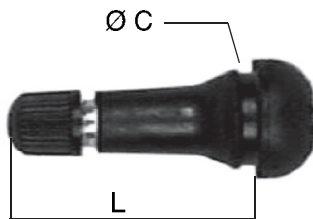

	TR	L	C	pz.
233 601	TR412	33	15	100
233 602	TR413	35	15	100
233 603	TR414	41	15	100
233 605	TR414L	48	15	100
233 607	TR418	54	15	100

Valvole tubless snap-in ad alta pressione, indicata per mezzi furgonati: IvecoDaily - Fiat Ducato

High pressure tubeless snap-in valve

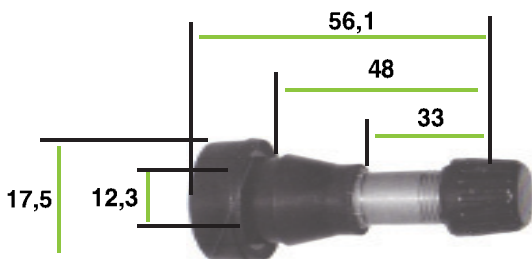

233 609 TR 600 - Pz 50

Pressione massima di gonfiaggio a freddo 5,5 BAR

Tappo valvole

Valve plug

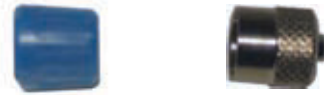

233 610 In plastica - Pz 100

233 611 In metallo - Pz 100

Introduttore valvole con percussore

Percussion valve introducer



233 620

mm 280

Valvola interna per valvole pneumatici

Inside valve for valves pneumatic



233 630 Valvola corta . Pz. 100

Pezze riparazioni camere d'aria SHRADER

Tube repair patches SHRADER

233 811	Ø 30	Pz 100
233 812	Ø 37	Pz 30
233 813	Ø 45	Pz 30
233 814	Ø 54	Pz 30
233 815	Ø 75	Pz 30
233 817	Ø 116	Pz 30



Pezze riparazioni camere d'aria SHRADER

Tube repair patches SHRADER

233 825 Ø35 Pz 100



Pezze riparazioni camere d'aria SHRADER

Tube repair patches SHRADER



233 835	45 x 45	Pz 50
233 836	60 x 60	Pz 50

Pezze riparazioni camere d'aria SHRADER

Tube repair patches SHRADER



233 841	55x75	20 Pz
233 842	70x115	10 Pz
233 843	85x130	10 Pz
233 844	90x75	20 Pz
233 845	115x125	10 Pz
233 846	100x195	10 Pz

Fungo riparazione tubless SHRADER

Tools tubless repair



233 866	Stelo Ø3	40 Pz
233 867	Stelo Ø6	24 Pz

Stringhe riparazione pneumatici

Laces reparation pneumatic

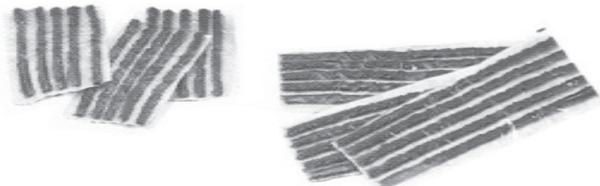

233 880	Stringa per vettura - Pz. 60
233 881	Stringa per autocarro - Pz. 30

Attrezzo riparazione pneumatici

Kit reparation pneumatic

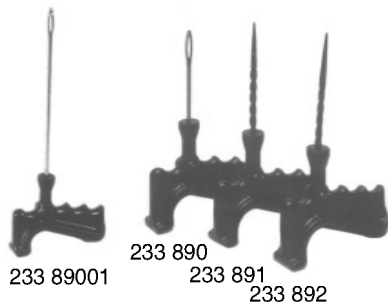

233 890	Attrezzo ad ago universale
233 890 01	Attrezzo ad ago universale lungo
233 891	Attrezzo soluzionatore.
233 892	Raspetta per vettura e Truck

Set riparazione pneumatici



233 893	Per vettura
233 894	Per Truck

Ricambi - Spare parts

233 880	Stringhe per vetture
233 881	Stringhe per truck
233 890	Attrezzo ad ago
233 892	Raspetta
233 89301	Valigetta vuota
233 895	Soluzione vulcanizzante 200cc

Soluzione autovulcanizzante per riparazione pneumatici

Solution autovulcanizer for reparation pneumatic



233 895	200 cc
---------	--------

Soluzione autovulcanizzante SCHRADER con pennello per riparazione pneumatici

Solution autovulcanizer SCHRADER for reparation pneumatic



233 896	Per camere d'aria - 250 cc - con pennello
233 897	Per pneumatici - 250 cc - con pennello
233 899	Pennello

Pasta montaggio pneumatici

Pasta assemblage pneumatic



- 233 898 Pasta per vetture - Kg 4
- 233 898 01 Pasta per autocarri - Kg 4

Rigatore elettrico per pneumatici

Electric cutter for pneumatic



- 233 900 SENZA LAME - 220 V

Lame ricambio per rigatore elettrico

Square blades for electric cutter



- 233 901 01 Lame - R1-3 20 Pz
- 233 901 02 Lame - R2-5 20 Pz
- 233 901 03 Lame - R3-6 20 Pz
- 233 901 04 Lame/ - R4-8 20 Pz
- 233 901 05 Lame - R5-10 20 Pz
- 233 902 01 Lame - W1-3 20 Pz
- 233 902 02 Lame - W2-5 20 Pz
- 233 902 03 Lame - W3-7 20 Pz
- 233 902 04 Lame - W4-9 20 Pz
- 233 902 05 Lame - W5-11 20 Pz

Misuratore battistrada°

Tread gauge



- 233 910

Calibro per il controllo del battistrada pneumatici

Acciaio Inox

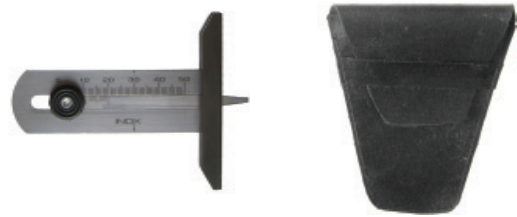

- | | Range mm | Base mm | |
|---------|----------|---------|-----------|
| 233 911 | 0 - 50 | 70 | In fodera |

Smonta ammortizzatori pneumatico universale potenziato per tutti gli ammortizzatori di tipo McPerson conici ed inclinati

Universal pneumatic device for assembly and disassembly all type McPerson shock absorbers

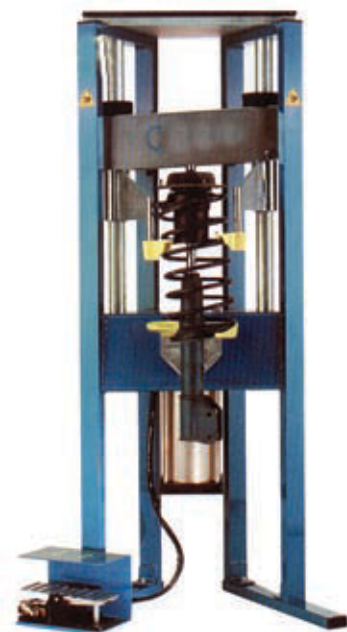

- 234 000

Dati Tecnici:
 Press.Esercizio Atm. Min. 6 Max 10
 Spinta Max Kg. 735 (Atm 6) Kg. 980 (Atm 8)
 Ingombro: 140x65x40 cm Kg. 72
 Adatta per ammortizzatori decentrati e conici con trave autolivellante - Pratico cassetto porta attrezzi.
 Dotazione: artt.234 00001 - 00002
 Optionals: artt.234 00003 - 00005 - 00006 - 00007

Staffe per smonta ammortizzatori 234 000

Brachet for device 234 000



- 234 000 01 Inclusa nell'art. 234 000 - Per molle Ø 78 - 130 mm
- 234 000 02 Inclusa nell'art. 234 000 - Per molle Ø 125 - 205 mm
- 234 000 03 Per molle Ø 105 -182 mm

Staffe per smonta ammortizzatori 234 000

Brachet for device 234 000



- 234 000 05 Staffa superiore per Mercedes Classe A e C
- 234 000 06 Staffa superiore per Mercedes Classe E
- 234 000 07 Kit staffe per Mercedes Classe A-C-E

Staffe per smonta ammortizzatori 234 000

Brachet for device 234 000



- 234 000 08 Staffa superiore per Porsche Cayenne e Tuareg

Morsa bloccaggio ammortizzatori per art. 234 000

Blocking vice for shock absorbers

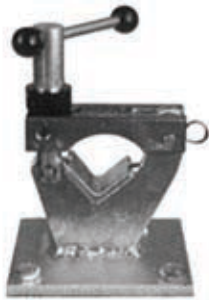

- 234 000 09 Opzionale

Smonta-ammortizzatori pneumatico a muro per tutti i tipi di ammortizzatori Mc Pearson

Wall Machine for disarm and reassemble all Mc Pearson system

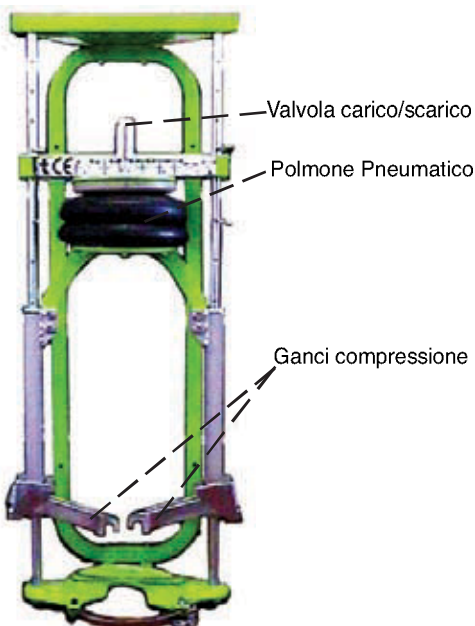

- 234 009 Normal Press. 1,5 - 2,5 Bar - Max - Press. 04 Bar - Corsa Soffietto 200 mm

Attrezzo pneumatico Brevettato per molloni ammortizzatori

Pneumatic tools "Patented" for soft dampers

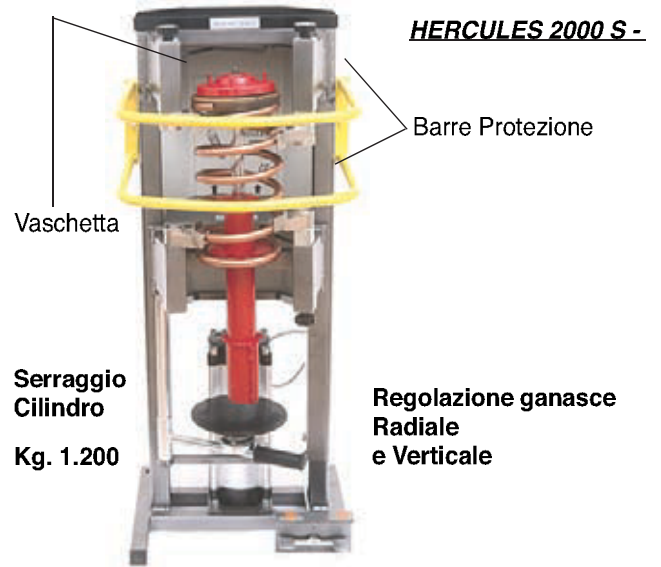

- 234 016 Dim. 46x45x115

Compressore per molle sospensione, perno a vite, spalla quadra, telescopico

Coil spring compressor



- 234 017 Mercedes

Attrezzo compressione molle sospensione anteriore

Front coil spring compressor



- 234 024 Renault Master

Attrezzo compressione molle sospensione anteriore

Front coil spring compressor



- 234 028 Giulia

Attrezzo compressione coni in gomma sospensione

Tool for rubber bush suspensions

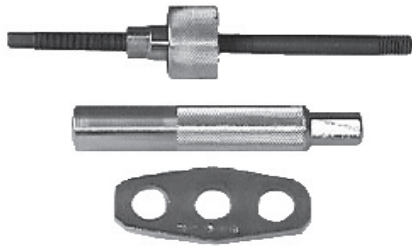

234 031 Mini-innocenti - 1/2" 20 fil - 14x2

Attrezzo con ganasce variabili per compressione molle ammortizzatori Mc-Pherson

Spring compressor Mc-Pherson

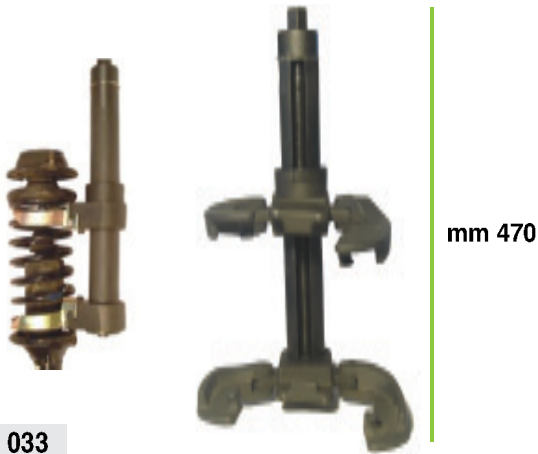

234 033

Attrezzo con 3 coppie intercambiabili di ganasce per compressione molle ammortizzatori

Interchangeable fork spring compressor and removal tool



Range 80 - 115



mm 125

Range 110 - 150

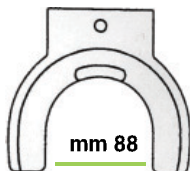

mm 160

Range 140 - 195

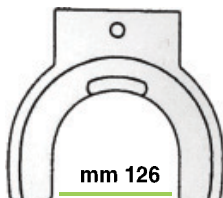

mm 212

mm 305

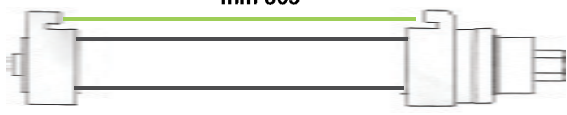

mm 453

234 035

234 035 01 Vite di ricambio

Compressore molle sospensioni

Coil spring compressor



234 040 Universale

Compressore molle sospensioni con doppio filetto destro e sinistro ed esagono centrale di manovra

Coil spring compressor

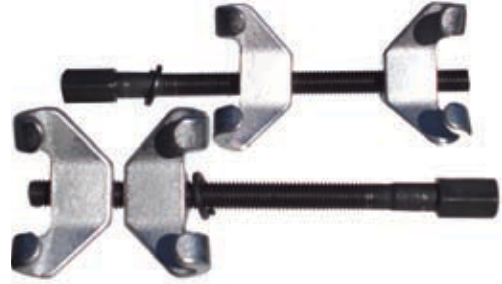

234 048 Universale - Apertura - 230 mm

Coppia compressori molle sospensioni con filetto destro/sinistro a sezione quadra e ganasce forgiate

Coil spring compressor



234 049 Max 800 Kgm - Viti mm 320

Coppia compressori molle per auto e furgoni, filetto a sezione quadra - ganasce in acciaio forgiato



234 050 Standard - Viti da mm 330

234 050 01 Coppia Viti Ricambio - Su richiesta - mm 260

234 050 02 Coppia Viti Ricambio - mm 320

Coppia compressori molle sospensioni con filetto destro/sinistro



234 052 Max 800 Kgm - Viti mm 270/320

Pressa bicilindrica smontamolle ammortizzatori con morsa orientabile per tutti gli ammortizzatori tipo Mac Person



234 060

Pressione di esercizio - Min. 6 bar Max 12 bar
Capacità di spinta - 6 bar Kg 800 - 8 bar Kg 1120
 10 bar Kg 1400 - 12 bar Kg 1680
Diametro molle - Min. mm 80 Max mm 230
Dimensioni - mm 600x580x1240
Peso - Kg. 68

Pressa smonta ammortizzatori pneumatica

Pneumatic tools



Leva sblocco protezione

Viti regolazione altezza ganci superiore

Schermo di protezione



Pedaliera azionamento pressa

234 065

Presse molle su tre punti

volantino di regolazione larghezza ganci

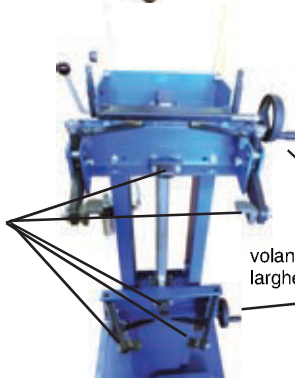

Dati tecnici - Informative

Dati tecnici:
 Min diametro molla: mm 80 - Max diametro molla: mm 310
 Corsa: mm 440
 Diametro pistone di spinta: mm145
 Misure: Altezza mm1400 - Larghezza mm580 - Profondità mm 500
 Peso: Kg 68
 Pressa dotata di uno schermo protettivo antifortunistico collegato ad un limitatore di pressione che a schermo alzato limita la pressione a 1.5 bar dando la possibilità all'operatore di posizionare la molla in sicurezza

Smonta-ammortizzatori manuale per molli Mec Pherson

Manual tools Mac person Mechanism



Supporto optional



Base optional



Piastra optional

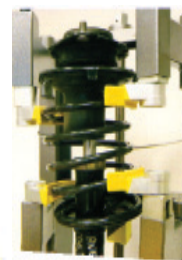

Sono predisposti 4 fori per il posizionamento a terra, consigliabile anche se non necessario

234 070

Adattatori opzionali - Optional adaptor



234 070 10 Piastra universale per ammortizzatori sportivi utilizzabile con i modelli: 234 016 "Hercules" - 234 070



234 070 11 Supporto regolabile



234 07012 Base supplementare mm 300

Dati tecnici - Informative

- Capacità di compressione: 1800 Kg
 - Larghezza: 45 Cm
 - Profondità: 40 Cm
 - Altezza: 118 Cm
 - Peso: 47 Kg

Rubinetto di carica

Excahnge charging tap



234 100 Innocenti-Rover

Chiave dado ritegno bracci oscillanti

Wrench for rear hubs ring nut



234 120 242 Diesel

Set di chiavi smontaggio dado ammortizzatori a bussola foro passante e cricchetto a frizione continua

Set of shock absorber wrenches with ratket



234 130 17-19-21-22-24 mm

Bussole ricambio / Sockets

234 131 17 mm

234 132 19 mm

234 133 21 mm

234 134 22 mm

234 135 24 mm

Chiave ghiera ritegno ammortizzatore

Spanner for hold shock absorber stem



234 145 Golf-Audi - 25 x 15 x 4

234 146 Polo - 25 x 12 x 4

234 147 Passat - 25 x 15 x 5

234 148 Rover - 25 x 12 x 3,5

Chiave smontaggio dado ammortizzatori

Wrench for shock absorber



234 150 Tipo-Punto - 18 mm

234 151 Passat-Audi 100-Marea - 19 mm

234 152 Golf - 21 mm

234 153 Audi 80-100-Kappa - 22 mm

Chiave smontaggio dado ammortizzatori

Wrench for shock absorber



234 165 Tipo-Punto - 18 mm

234 166 Passat-Audi 100-Marea - 19 mm

234 168 Audi 80-100-Kappa - 22 mm

Chiave supporto motore lato distribuzione Citroen

Key timing side engine mount Citroen

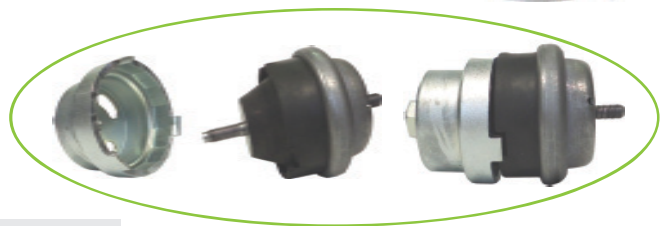

234 160

Chiave ritegno stelo ammortizzatori

Wrench for retaining shock absorber



234 170 Ritmo-Regata

Chiave smontaggio dado ammortizzatori

Wrench for shock absorber



234 171 Fiat 126-Nuova 500 - Int femmina 6 mm - 17 mm

234 172 Fiat Uno - Int femmina 7 mm - 19 mm

234 173 Peugeot-Renault R14 - Int a lama 10 mm - 21 mm

234 174 Alfa 164 - Int brugola 7 mm - 22 mm

Attrezzo con pistone idraulico per estrazione ed inserimento boccole Silentblock su ponti posteriori

Extraction / Introducer tool silentblock



Per vederne l'utilizzo tramite filmato clicca:

WWW.AFASUPPORT.IT

CLICCA: 234 204 silent blc

"Per Fiat STILO e Nuova BRAVO"



- 234 204 solo attrezzo con 2 pressori e 1 guida
- 234 204 01 Attrezzo con 2 pressori e 1 guida + Pompa idraulica manuale
- 234 204 02 Attrezzo con 2 pressori e 1 guida + Pompa idraulica pneumatica

Ricambi - Spare-parts



234 204 03 Pistone idraulico



234 204 04 Coppia di tiranti



234 204 05 Pressore con 3 perni per inserimento



234 204 06 Pressore a tazza per estrazione



234 204 07 Piastra filettata superiore



234 204 08 Piastra di contrasto inferiore



234 204 09 Pompa idraulica manuale - 450 bar - 17 Ton



234 204 10 Pompa idraulica pneumatica - 700 bar - 20 Ton



234 204 40 guida introduttrice

Valvola a innesto rapido con maschio da 1/4" con ritenuta per pompe idrauliche 234 20409 / 20410



234 204 11

Riduzioni / Aumentatori da applicare ai pistoni dei pistoni crick da fossa utilizzabili con nostri articoli: 234 204 35 e 520 610 10



Riduzioni	A	B
234 204 22	ØEst. 35	x pistoni Ø 22
234 204 25	ØEst. 35	x pistoni Ø 25
234 204 30	ØEst. 35	x pistoni Ø 30



Aumentatori	A	B
234 204 40	ØInt. 45	x pistoni Ø 40
234 204 45	ØInt. 45	x pistoni Ø 45



Adattatore orientabile con blocco perno a sfera per nostro 234 204 (estrattore silent block)

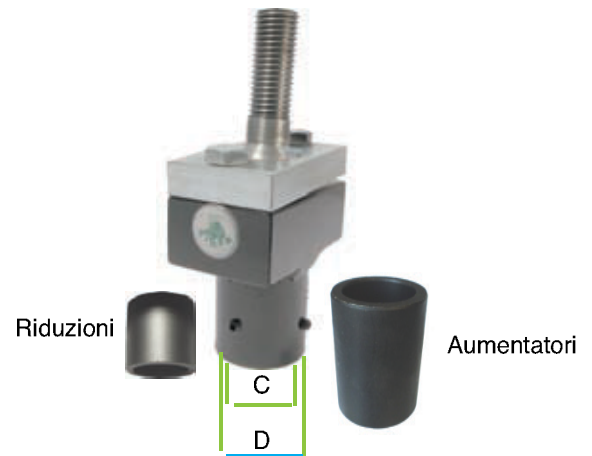

	C	D
234 204 35	Ø 35	Ø 45

L'adattatore monta di serie un innesto per il pistone del crick di Ø35, mentre i per pistoni di Ø22, Ø25, Ø30, Ø40, Ø 45 come optional - a richiesta sono disponibili 5 adattatori



Piattello in ferro con tampone "Long life" utilizzabile su crick da fossa con pistone Ø 35

Long life rubber block for crick

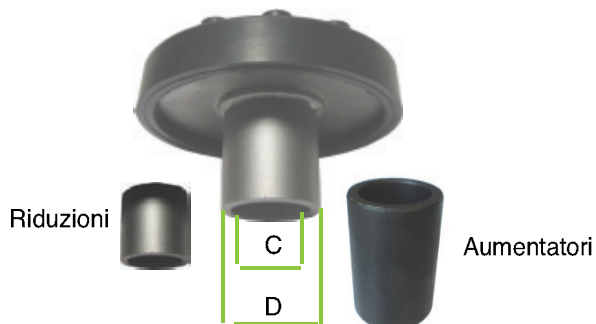

	C	D
520 610 10	Ø 35	Ø 45

Il piattello monta di serie un innesto per il pistone del crick di Ø35, mentre i per pistoni di Ø22, Ø25, Ø30, Ø40, Ø 45 come optional a richiesta sono disponibili 5 adattatori

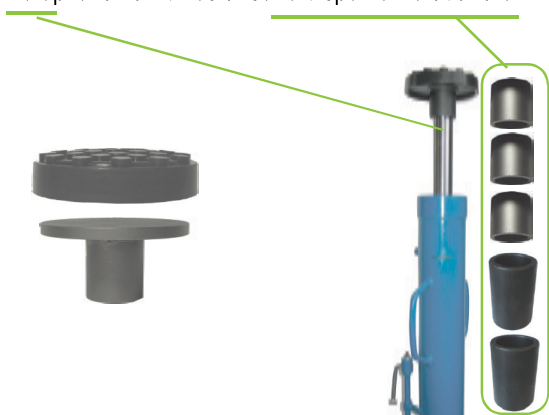

Estrattore economico a vite per silent block ponte posteriore Fiat Stilo e nuova Bravo

Extraction silent block Fiat Stilo & Bravo new

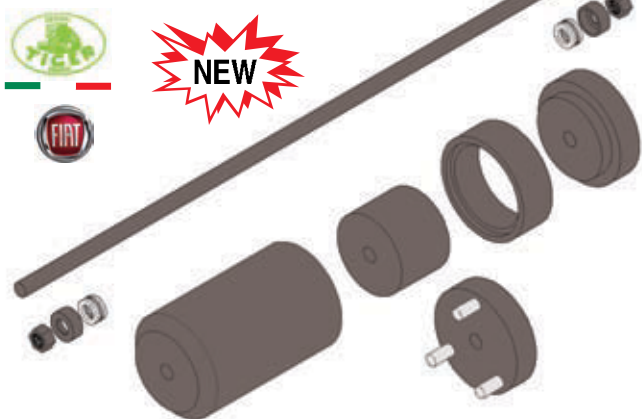

234 204 50 New kit completo

Ricambi - Spare-parts

- 234 204 51 Anello tubo a ø85x68x140
- 234 204 52 Anello tubo b ø85x67x30
- 234 204 53 Anello pieno c ø57,3x50
- 234 204 54 Anello pieno d ø85x30
- 234 204 55 Anello pieno e ø85 3perni
- 234 204 56 Barra filett.acc.b7 m12x350
- 234 204 57 Cusc.reg/spinta cad.
- 234 204 58 Bicchiere x cusc.r/spinta
- 234 059 Tondo guida

Estrattore / Introduttore Silentblock su Panda Natural power Metano 4 x 4

Extraction silent block Fiat Stilo & Bravo new



Introduttore



Estrattore



234 204 70 Kit A.F.A

Attrezzo montaggio boccole elastiche bracci oscillanti sospensione anteriore

Tool rear suspension swinging arm bushing



234 205 127-A112-128-500-Uno-Regata

234 206 127-A112

Attrezzo montaggio boccole elastiche barra stabilizzatrice posteriore

Tool stabilizer bar bushing



234 207 Croma

Attrezzo montaggio boccole elastiche ponte posteriore

Tool rear suspension swinging arm bushing



234 210 Volvo 240

Attrezzo montaggio boccole elastiche sospensione anteriore

Tool front suspension swinging arm bushing



234 211 Daily-Grinta

Chiave ghiera boccole elastiche sospensione anteriore

Wrench nutl front suspension swinging arm bushing



234 212 Daily-Grinta - 32 x 28 x 4

Chiave ghiera cuscinetto braccio sospensione

Wrench nut swinging arm suspension



234 213 Peugeot 205 - 69 x 49 x 6,5

Kit in valigia di plastica per estrazione ed inserimenti cuscinetti, silentblock e boccole



234 215 28 Pz

Composizione - Composition

- 20 Boccole Ø interno: 34 - 36 - 38 - 70 - 72 Ø esterno: 44 - 46 - 48 - 80 - 82
- 4 - Step disc
- 4 - Viti estrazione con dado

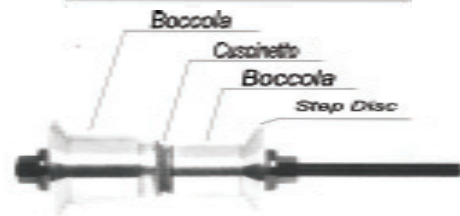

Ricambi - Spare-parts



234 215 10 Vite M10 con 2 cuscinetti reggi spinta



234 215 12 Vite M12 con 2 cuscinetti reggi spinta



234 215 14 Vite M14 con 2 cuscinetti reggi spinta



234 215 16 Vite M16 con 2 cuscinetti reggi spinta

Kit in valigia rigida per estrazione / inserimento cuscinetti, Silentblock e boccole

Press-on sleeve kit



234 218 Pz 24

Composizione - Composition



- 20 Boccole: Ø Interno / Esterno: 34/44 - 36/46 - 38/48 - 40/50 - 42/52 - 44/54 - 46/56 - 48/58 - 50/60 - 52/62 - 54/64 - 56/66 - 58/68 - 60/70 - 62/72 - 64/74 - 66/76 - 68/78 - 70/80 - 72/82
- 4 Viti estrazione + dado e cuscinetto: M10 - M12 = M14 - M16

Kit estrattore boccole idraulico con capacità di spinta pari a 12 Ton. - In trolley -

Hidraulic 12 ton. steering sistem pull toll set - In trolley

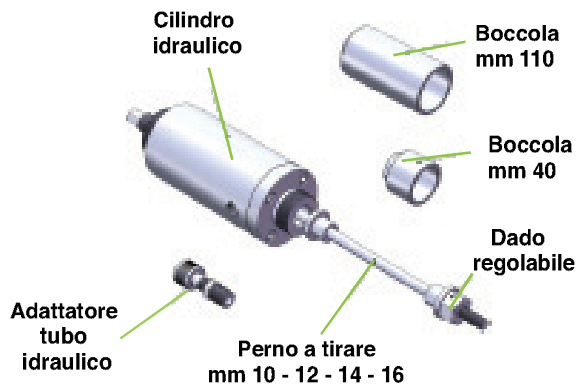
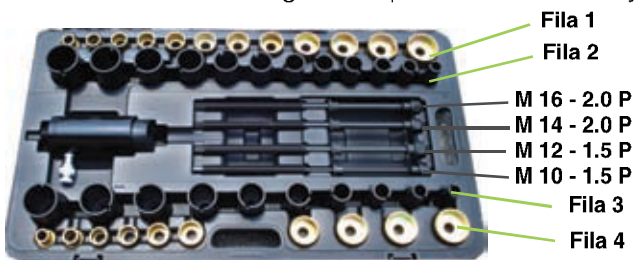

CM 90



CM 50

234 220 Universale - Trolley Kg 31

Composizione - Composition

- Fila 1 - 28x20 - 32x24 - 36x28 - 40x32 - 44x36 - 48x40 - 50x42 - 52x44 - 56x48 - 60x52 - 64x56 - 68x60 (Altezza mm 40)
- Fila 2 - 68x60 - 64x56 - 60x52 - 56x48 - 52x44 - 48x40 - 44x38 - 42x34 - 40x32 - 38x28 - 32x24 - 28x20 (Altezza mm 110)
- Fila 3 - 66x58 - 62x54 - 58x50 - 54x46 - 50x42 - 46x38 - 38x30 - 34x26 - 30x22 - 26x18 (Altezza mm110)
- Fila 4 - 26x18 - 30x22 - 34x26 - 38x30 - 42x34 - 46x38 - 54x46 - 58x50 - 62x54 - 66x58 (Altezza mm 40)

NOTE



Kit estrattore boccole idraulico con capacità di spinta pari a 12 Ton. - In trolley -

Hidraulic 12 ton. steering sistem pull toll set - In trolley



Tubo idraulico

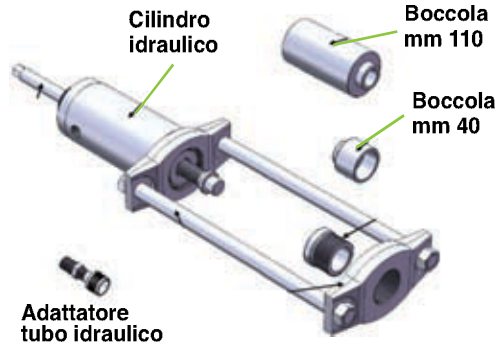

CM 90



CM 50

234 221 Universale - Trolley Kg 31

Composizione - Composition

- Fila 1 - 28x20 - 32x24 - 36x28 - 40x32 - 44x36 - 48x40 - 50x42 - 52x44 - 56x48 - 60x52 - 64x56 - 68x60 (Altezza mm 40)
- Fila 2 - 68x60 - 64x56 - 60x52 - 56x48 - 52x44 - 48x40 - 44x38 - 42x34 - 40x32 - 38x28 - 32x24 - 28x20 (Altezza mm 110)
- Fila 3 - 66x58 - 62x54 - 58x50 - 54x46 - 50x42 - 46x38 - 38x30 - 34x26 - 30x22 - 26x18 (Altezza mm110)
- Fila 4 - 26x18 - 30x22 - 34x26 - 38x30 - 42x34 - 46x38 - 54x46 - 58x50 - 62x54 - 66x58 (Altezza mm 40)



www.afasupport.it

Kit per estrazione inserimento cuscinetti del gruppo - VAG

Wheel hub / wheel bearing tool set

utilizzabile su veicolo / pressa



234 250 Pz 15

Dati tecnici - Informative

- Audi A2 dal 2000 / Skoda Fabia dal 2000
- Vw Polo dal 2002 / Seat Ibiza dal 2000
- Fox dal 2005

Spurgafreni e frizioni a membrana



Terza camera di riserva per più operazioni a pressione costante dotata di due taniche recupero olio e imbuto di riempimento. Senza tappi in dotazione.

234 907

Capacità olio (camera superiore) - 5 Litri -
Max bar utilizzo (camera centrale) - 2 bar
Max bar riserva (camera inferiore) - 10 bar -
Lunghezza tubo erogazione - 3 Mt
Valvola di sicurezza - 10 bar

Spurgafreni e frizioni a membrana



Terza camera di riserva per più operazioni a pressione costante dotata di due taniche recupero olio e imbuto di riempimento. Dotazione tappi standard.

234 908

Capacità olio (camera superiore) - 5 Litri
Max bar utilizzo (camera centrale) - 2 bar
Max bar riserva (camera inferiore) - 10 bar
Lunghezza tubo erogazione - 3 Mt
Valvola di sicurezza - 10 bar

Serie tappi standard composta da 5 tappi a vite (A-D-F-I-T) ed un tappo universale (W)

Tool rear suspension swinging arm busching



234 909

Tanichetta recupero olio freni



234 910 Tanichetta

234 910 01 Tubo di ricambio

Serie tappi extra a vite (B-C-E-G-H-K-L-M-P-R-U-X-Y-Z)



234 911

Spurgafreni pneumatico

Pneumatic brake oil extractor



235 045

Ricambi - Spare-parts



235 045 01 Attacco con pipetta

235 041 Solo pipetta

LETTURA CODICI		↓	↓	↓	↓	↓	↓	↓	↓	↓	↓	↓	↓	↓	↓	↓	↓	↓	↓	
ELENCO TAPPI		2	2	2	2	2	2	2	2	2	2	2	2	2	2	2	2	2	2	
		3	3	3	3	3	3	3	3	3	3	3	3	3	3	3	3	3	3	
		4	4	4	4	4	4	4	4	4	4	4	4	4	4	4	4	4	4	
		9	9	9	9	9	9	9	9	9	9	9	9	9	9	9	9	9	9	
		1	1	1	1	1	1	1	1	1	1	1	1	1	1	1	1	1	1	
		1	1	1	1	1	1	1	1	1	1	1	1	1	1	1	1	1	1	
		0	0	0	0	0	0	0	0	0	1	1	1	1	1	1	1	1	1	
		1	2	3	4	5	6	7	8	9	0	1	2	6	7	3	4	8	5	9
		A	B	C	D	E	F	G	H	I	K	L	M	P	R	T	U	X	W	Z
	A U T O V E T T U R E	ALFA	●			●						●								
AUDI					●															
AUSTIN MORRIS		●			●											●				
AUTOBIANCHI			●						●											●
BMW					●															●
CITROEN					●	●				●										
DAF		●			●															
FERRARI					●			●	●											
FIAT		●	●						●	●										
FORD		●			●											●				
INNOCENTI		●			●								●							
JAGUAR												●								
LAMBORGHINI					●				●											●
LAFER				●																
LADA									●											
LANCIA					●															●
LAND ROVER																●				●
LEYLAND		●																		
MASERATI					●			●					●							
MITSUBISHI											●						●			
MATRA					●															
MAZDA																				●
MERCEDES					●															
NISSAN																				●
NSU					●															
OPEL					●		●													
PEUGEOT					●		●						●							
PORSCHE				●	●															
RENAULT					●			●		●			●							
ROVER		●																		
SAAB					●															
SEAT					●				●											
TALBOT				●		●														
TOYOTA																			●	
TRIUMP															●					
VAUXHALL	●																			
VOLKSWAGEN			●	●																
VOLVO				●			●													

T R U C K	ASTRA								●										
	BEDFORD	●						●			●								
	BERLIET				●		●							●		●		●	
	DAF				●														
	EBRO						●			●									
	FIAT	●	●		●			●	●				●						
	FORD				●			●											
	MAGIRUS				●														
	MERCEDES				●														
	PEGASO Comet						●												
	RENAULT				●		●			●							●		●
	SAVIEM				●		●			●							●		●
	SCANIA				●			●											
	UNIC						●		●	●				●					
	VOLVO														●				

Unico attrezzo per riempimento filtro gasolio e spurgafreni pneumatico



NEW



235 046 Completo di tubi e raccordi

Ricambi - Spare-parts

235 041 Solo pipetta

235 045 01 Attacco con pipetta

235 046 01 Tubo Ø6

235 046 02 Tubo Ø8

235 046 03 Raccordo maschio Ø9

235 046 04 Raccordo maschio Ø9,5

Chiavi doppie per raccordi tubetti freno

Wrench for operating on brake connectors



235 065 8x9 mm

235 066 10x11 mm

235 068 14x17 mm

Kit di spurgo e recupero olio freni

Kit for draining oil brakes



235 053

NOTE



Chiavi per raccordi tubetti freno

Wrench for operating on brake connectors



235 054 Set 7 pcs 8-9-10-11-12-13-14

Ricambi - Spare-parts

235 055 8 mm **235 059** 12 mm

235 056 9 mm **235 060** 13 mm

235 057 10 mm **235 061** 14 mm

235 058 11 mm

Chiave da 11 fissa e snodata per condotti freni con molla apri e chiudi brevettata

Brake pipe wrench



235 070

Chiave registro freni

Wrench adjusting brakes



235 076 Mini Minor

Chiave registro freni

Wrench adjusting brakes



235 077 Simca 1000

Chiave registro freni

Wrench adjusting brakes



235 078 Citroen GS

Chiave registro freni

Wrench adjusting brakes



235 079 Alfa Sud - 17 mm

Chiave registro freni

Wrench adjusting brakes



235 080 Fiat - 17 mm

Chiave registro freni

Wrench adjusting brakes



235 081 Renault-Peugeot-Citroen - 1/2" - Penta

Chiave registro freni

Wrench adjusting brakes



235 082 Renault-Peugeot-Citroen - Penta

Chiave registro freni

Wrench adjusting brakes



235 083 Renault - 10 mm

Chiave registro freni

Wrench adjusting brakes



235 084 Renault - 10 mm

Set 6 chiavi raccordi tubi freno

6pcs brake bleeder wrench



235 085 In valigetta

Composizione - Composition

Chiave:	Esagono aperto 5/16"	Quadro 1/4"
Chiave:	Esagono aperto 7/16"	Quadro 11/32"
Chiave:	Quadro 1/4"	Quadro mm 10
Chiave:	Esagono 1/4"	Esagono mm 7
Chiave:	Esagono mm 8	Esagono mm 10
Chiave:	Esagono mm 9	Esagono mm 11

Pinza piegatura tubetti freno sostegno durante il taglio o il montaggio

Plier for aid brake connectors



235 090 4,75 mm

Attrezzo montaggio molle ganasce freni posteriori al porta ceppi

Tool for refitting brake shoe retaining spring



235 091 Fiat

Estrattore dischi freno

Puller for brake disc



235 099 Fiat 127-128-131-Ritmo.

Estrattore tamburi freno

Puller for flange axle



235 100 Fiat 127

Estrattore tamburi freno

Puller for flange axle



235 101 Alfa Sud

Estrattore tamburi freno

Puller for flange axle



235 102 apertura 150-350 mm / profondità 125 mm

Estrattore tamburi freno

Puller for flange axle

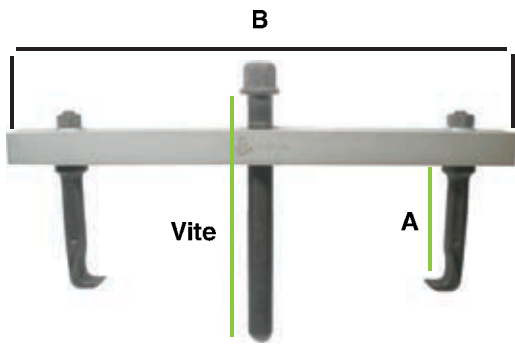

235 103 **A** **B** **Vite**
mm 95 mm 380 mm 195

Adattatori opzionali - Optional adaptor

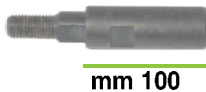

111 033 01 Prolunga



Estrattore tamburi freno

Puller for flange axle



235 104 Diametro max 120 mm

Estrattore tamburi freno

Puller for flange axle



235 105 FIAT

Estrattore tamburi freno con zampe registrabili

Puller for flange axle



235 106 Universale

Attrezzo arretramento pistoncini freno

Equip withdrawal piston brake



235 112

Attrezzo rotazione pistoncini freno

Tool for rotating brake disc piston



235 120 Uno turbo ie - 28 x 18 x 7 conico

Attrezzo rotazione pistoncini freno

Tool for rotating brake disc piston



235 121 Alfa 33-164 28 x 18 x 7 conico
35 x 26 x 6 conico

Attrezzo rotazione pistoncini freno

Tool for rotating brake disc piston



235 122 Croma - 37 x 24 x 7 conico

Attrezzo rotazione pistoncini freno

Tool for rotating brake disc piston



235 123 Renault

Attrezzo rotazione pistoncini freno

Tool for rotating brake disc piston



235 124 Bravo-Coupè-Barchetta-Kappa

Attrezzo rotazione pistoncini freno

Tool for rotating brake disc piston



235 130 Universale - 3/8"

Set bussole pentagonali per pinze freni. Att.1/2"

3 pcs 1/2" pentagon socket

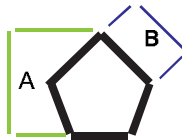

1/2"

235 134 Pz. 3

Ricambi - Spare-parts



		A	B
235 081	Pentagono maschio	mm 10	mm 7
235 135	Pentagono femmina	mm 14	mm 10
235 136	Pentagono femmina	mm 19	mm 1/2"

Set rotazione pistoncini freno Dx / Sx

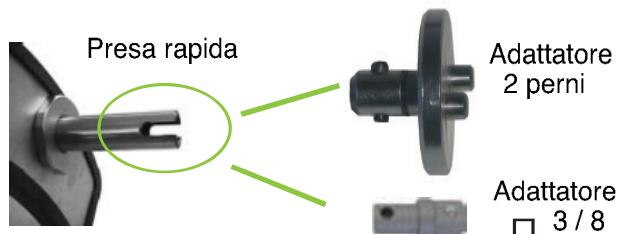
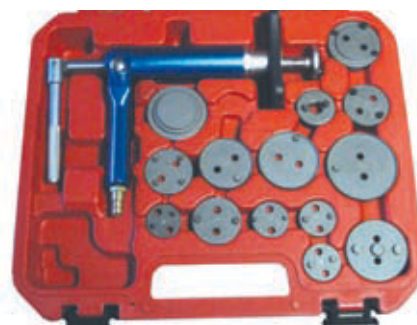

235 137 Kit in valigetta senza presa rapida

235 137 05 Kit in valigetta con presa rapida

Ricambi - Spare-parts

235 137 01 Solo pistola senza presa rapida

235 137 06 Solo pistola con presa rapida

235 137 07 Solo adattatore 2 perni

235 137 08 Solo adattatore □ 3 / 8

Adattatori opzionali - Optional adaptor



Adattatore ribassato intercambiabile con nostro attrezzo pneumatico per rotazione pistoncini freni a disco, da utilizzare in presenza di pastiglie usurate
Adaptor for pneumatic piston brake



Pressore per cilindretti freno



235 137 20 Ford Focus / C-Max - Attacco 2 fori

Pressore per cilindretti freno

Adapter

235 137 21

235 137 22



235 137 21 Pastiglia Ø30 con spine Ø 4

235 137 22 Pastiglia Ø32 con spine Ø 4

Pressore per cilindretti freno



235 137 50 Iveco Daily - Attacco 2 fori

Set rotazione pistoncini freno per auto giapponesi ed europee e USA

Kit rotation brake pistons for Japanese, EU and USA cars



235 138 Rotazione destra

NOTE



Attrezzo rotazione pistoncini freno destro e sinistro



Citroen/XM,Xantia,Audi,FIAT/Alfa Romeo,FordFiesta - ISUZU,HONDA/Concesto. Jaguar/XJ6,XJ40BMW/318is - 320i, 325TD, 518i, 525i & lx, 740i, 850ci, M5 - Mercedes Benz 190, 200, 300, 420,560,MitsubishiColt - NISSAN/ Mlera Stanza, Sunny,Rover Austin, Metro, 200 - 400,Maestra,Montego,TOYOTA Camry,Volvo, VW - Passat,Golf GTI, FORD Australia, NZ,Telstar, Laser - MAZDA,SAAB 9000, FIAT/Alfa Romeo 164 2.0 - HONDA/Prelude, CRX 16i,GM/ Saturn,NISSAN - PRIMERA , VW/Golf IV,Audi 80, 90, V8, 100, Coupe - Rover 800 ABS, SUBARU L+Z, FORD Sierra ABS - Granada, Scorpio ABS 85, NISSAN Bluebird 1.8 - Turbo, Silvia Turbo Primera 2.0i LS/GS/GSX - PEUGEOT/405 1.9Gi, Gri,Sri, Gtxi, MI 16, 605 2.0 - Sri,TOYOTA Celica, Corolla GT, MR2, VW/Golf Gti, Jetta - Synchro, Jetta Gti 16V, Passat CL, GL, GT and GT 16V - Corrado 16V,Scirrocco GTX 16V,GM most 1-7/8" diameter pistons GM most 2-1/8" diameter pistons GM most 2-1/2" diameter pistons Renault R21 - Laguna, Ford Modeo - SAAB - Honda.Open - Citoren, NISSAN Maxims.

235 139

Attrezzo rotazione pistoncini freni

Rotation brake pistons

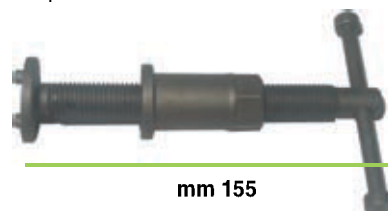

mm 155

235 139 Dx "Destro"

235 139 Sx "Sinistro"

Set rotazione pistoncini freni destro



235 140 in valigetta



Set rotazione pistoncini freno destro e sinistro con perno centrale sfilabile in caso di blocco attrezzo



235 140 10 Kit completo - 14 Pz

Composizione - Composition

- 235 141** Estrattore completo destro - 3/8
- 235 141 01** Estrattore completo sinistro - 3/8
- 235 142** Esagono - 12 mm
- 235 143** Diam 31.5 - 2 perni diam 5 mm
Interasse 21 mm
- 235 144** Diam 35 - 2 perni diam 6 mm
Interasse 21 mm
- 235 145** Diam 41 - 2 perni diam 6 mm
Interasse 34 mm
- 235 146** Diam 44 - 2 perni diam 6 mm
Interasse 33 mm
- 235 147** Diam 52 - 3 perni diam 6 mm
Interasse 44 mm
- 235 148** Snodo Diam 66 - diam interno 33 mm 44 mm
- 235 149** Piastrina
- 235 150** Diam 36 - Fiat Stilo e Multipla
- 235 151** Diam 45 - Fiat Ducato
- 235 152** Diam 35 - Alfa Romeo
- 235 153** Diam 28 - Alfa Romeo - Audi - Volkswagen

Ghiera per arretramento pistoncini freni

Ferrule for withdrawal little pistons you brake



235 150 Fiat Stilo - Ø36

Pressore per cilindretti freno per Renault Laguna

Ferrule for withdrawal little pistons you brake



235 150 01 Attacco - 3/8"

Pressore per cilindretti freno per Audi 100

Ferrule for withdrawal little pistons you brake



235 150 02 Attacco - 3/8"

Pressore per cilindretti freno per Citroen BX

Ferrule for withdrawal little pistons you brake



235 150 03 Attacco - 3/8"

Pressore per cilindretti freno per Citroen C 5 - C 6

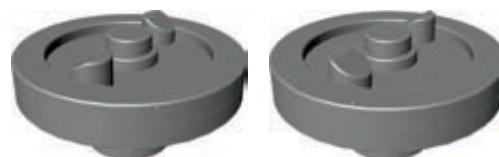

235 150 04 C 5 - Cilindretto destro - Attacco - 3/8"

235 150 05 C 6 - Cilindretto sinistro - Attacco - 3/8"

Pressore per cilindretti freno per Ford Focus



235 150 06 Attacco - 3/8"

Pressore per cilindretti freno per Nissan



235 150 07 Attacco - 3/8"

Pressore per cilindretti freno per Subaru



235 150 08 Attacco - 3/8"

Pressore 3 denti per cilindretti freni Ford



Utilizzabile con
art. 235 14010



235 150 20 Attacco - 3/8"

Ghiera per arretramento pistoncini freni

Ferrule for withdrawal little pistons you brake



235 151 Daily - Ø45

Ghiera per arretramento pistoncini freni

Ferrule for withdrawal little pistons you brake

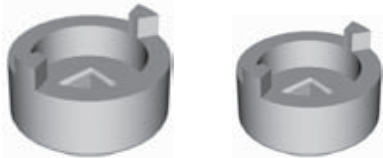

235 152 Alfa Romeo - Ø35

235 153 Alfa Romeo - Audi - VW - Ø28

Nuovi piattelli per 235 140 e 235 14010 per vetture BMW



235 154 01 BMW serie 3 e 5 ultimo tipo

235 154 02 Mini By BMW

235 154 03 BMW 1° serie

Attrezzo per comprimere pistoncini freno

Tool for retain brake disc piston



235 155 Fiat 131-132-124-125-127-Panda-Ritmo

Chiave ganasce freni

Wrench for refitting dampers



235 157 Alfa 33 4x4 - 8 mm

Chiave per ghiera anello di comando freni

Wrench for adjusting brakes nuts



235 158 Audi - 28 x 18 x 4

Chiave per montaggio pinze freni

Wrench for refitting disc brake



235 161 Peugeot-Renault-Citroen - 5 lati 19 mm

Attrezzo per ceppi freno

Tool for brakes

235 165 Universale

Attrezzo doppio per molle ceppi freno

Tool double for dampers

con cappuccio
antifortinistico

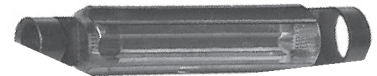

235 167 Universale

Attrezzo per molle ceppi freno

Tool for dampers

235 168 Universale

Chiave a bussola pinze freni Audi e Volkswagen



235 169 XZN forato - M 14

Pinza molle freni

Plier for refitting dampers



235 170 Universale - 220 mm

Pinza molle freni a tamburo

Plier for refitting dampers



235 174 Universale - 320 mm

Pinza molle freni con estrattore tenuta molle

Plier for refitting dampers



235 176 Universale - 330 mm

Pinza per cavo freno a mano

Plier for brake



235 180

Pinza per molle ganasce freni a tamburo

Plier for brake hubs spring

Made in Germany

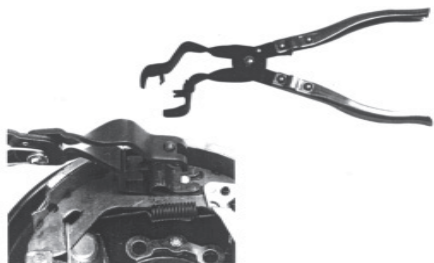

235 182 mm 230

Pinza per molle freni autocarro

Brake spring pliers



mm 540



235 185 mm 540

235 185 01 Gancio di ricambio

Kit per ripristino filetti freni a disco V.A.G. - Opel - Ford



235 195 In valigetta



Chiave regolazione freni Audi, Penta Tx - forata



Att. 

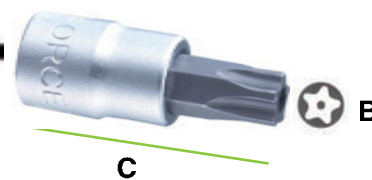

3/8"

	Att.	B	C
235 286	3/8"	Ts 55	mm 48

NOTE



Rettifica per dischi freni MAD

MAD disc aligner



235 300 Un vero e proprio tornio per risolvere i problemi causati da usura irregolare o decentrata, senza smontare il disco della vettura

Composizione - Composition

Motore con carrello + Tornio con materiale di fissaggio 1 serie di placchette (235 312) + 1 piastra rotaz. ruota (235 305)

Dati tecnici - Informative

Il metodo della rettifica "sul veicolo" è opportuno in tutti quei casi in cui l'usura irregolare o decentrata dei dischi freno provoca ruvidità di frenata o vibrazioni del volante, ed è estremamente pratico in quanto permette la lavorazione dei dischi dei freni senza che vengano smontati dal veicolo! Non a caso il tornio dischi freni "MAD" è approvato e usato da molte delle maggiori case automobilistiche, tra cui il gruppo Fiat.

- Conforme alle norme di sicurezza europee (CE) e alle norme IEC-1029-1/CSA
- Costruito con tecnologie avanzate; è altamente preciso per via della doppia guida brevettata che consente risultati abbondantemente inferiori alle tolleranze indicate dalle case automobilistiche
- Può essere montato facilmente su ogni tipo di autovettura, fuoristrada e furgone grazie alle speciali piastre di montaggio. - L'adattatore di trasmissione è unico per tutti i tipi di veicoli.
- E' fornito con utensili da taglio a forma triangolare a lunga durata.
- Venduto in ben 60 Stati.

Composizione - Composition



235 305 Staffa trascinalimento per unità di comando



235 312 Utensili da taglio triangolari con profilo positivo e vite - Pz 2

Adattatori opzionali - Optional adaptor



235 301 Slitta montaggio universale Rossa, per portapinzze non filettate

235 302 Slitta montaggio universale Blu, per portapinzze filettate

Adattatori opzionali - Optional adaptor



235 303 Prolunga per slitta rossa

235 304 Prolunga per slitta blu



235 305 01 Staffa di trascinalimento da applicare all'unità di comando per i veicoli fuoristrada e dei furgoni



235 308 Anello antivibrante Giallo Ø 220 x 24, per dischi da Ø 240 a 350 mm, riduce il rumore e ottiene una finitura liscia

235 309 Anello antivibrante Rosso Ø 220 x 8, per dischi da Ø 240 mm, riduce il rumore e ottiene una finitura liscia

235 310 Anello antivibrante Grigio Ø 160 x 8, per dischi da Ø 175 a 240 mm, riduce il rumore e ottiene una finitura liscia



235 311 Utensili da taglio triangolari + vite. Profilo piatto - Pz 2

235 311 10 Utensili da taglio triangolari + vite. Profilo piatto - Pz 10

235 312 10 Utensili da taglio triangolari + vite. Profilo positivo - Pz 10



235 315 Adattatore freni radiale, per freni radiali montati su: Ferrari - Lexus - Porsche - Audi - Vw - BOL KIT richiesto dalla marca dell'automobile

Set montaggio / smontaggio freni

High quality brake tool set



236 000

Contiene: Pinze per molle freni - Pinza per cavo freno a mano - 2 spazzole - Perni per rimuovere lo sporco - Utensili per molle freni a mano - Utensili per molle freni a tamburo - Cacciavite a snodo - Chiave per tubetti freni. Chiave registro freni.