

Giravite a lama per meccanica impugnatura in materiale bi plastico

Slotted head screwdriver with bi plastic handle

Acciaio Mo V
Lama cromata punta nera



	qt.	Øx - Lx - Spess
410 001	12	3x75x0.5 mm
410 003	12	4x100x0.6 mm
410 004	12	5x100x0.8 mm
410 005	12	5x125x0.8 mm
410 006	12	6x100x1 mm
410 007	12	6x125x1 mm
410 008	12	6x150x1 mm
410 009	12	7x150x1.2 mm
410 010	12	7x200x1.2 mm
410 011	12	8x200x1.6 mm

Giravite a lama per elettricista impugnatura in materiale bi plastico

Slotted head screwdriver with bi plastic handle

Acciaio Mo V
Lama cromata punta nera



	qt.	Øx - Lx - Spess
410 021	12	2.5x75x0.4 mm
410 022	12	2.5x100x0.4 mm
410 024	12	3x75x0.5 mm
410 025	12	3x100x0.5 mm
410 026	12	3x150x0.5 mm
410 029	12	4x100x0.6 mm
410 031	12	4x150x0.6 mm

Giravite a croce phillips impugnatura in materiale bi-plastico

Phillips screwdriver with bi plastic handle

Acciaio Mo V
Lama cromata punta nera



410 040	12	Ø 3 Ph 0x60 mm
410 041	12	Ø 5 Ph 1x80 mm
410 042	12	Ø 5 Ph 1x100 mm
410 044	12	Ø 6 Ph 2x100 mm
410 045	12	Ø 6 Ph 2x125 mm
410 047	12	Ø 8 Ph 3x150 mm
410 048	12	Ø 10 Ph 4x200 mm

Giravite a croce pozidrive impugnatura in materiale bi plastico

Pozidrive screwdriver with bi plastic handle

Acciaio Mo V
Lama cromata punta nera



410 051	12	Ø 3 Ph 0x60 mm
410 052	12	Ø 4.5 Ph 1x80 mm
410 053	12	Ø 6 Ph 2x100 mm
410 054	12	Ø 8 Ph 3x150 mm

Serie di giraviti impugnatura in materiale bi plastico

Set of screwdrivers with bi plastic handle

Acciaio Mo V
Lama cromata punta nera



410 070 3x75-4x100-5x125-6x150
PH 1x80-2x100 - 6 pcs

FORNITI NON IN SCATOLA.

Set cacciaviti 7 pz. con punta nera

Set 7 pcs. screwdriver with black terminal

Acciaio Mo V
Lama cromata punta nera



410 072 01

Composizione - Composition

qt	art.	Øx - Lx - Spess
1	410 024	3x 75 EI
1	410 029	4x100 EI
1	410 005	5x125 M
1	410 008	6x150 M
1	410 040	0x60 PH
1	410 041	1x80 PH
1	410 044	2x100 PH

Giravite a lama per meccanici impugnatura in acetato di cellulosa nero

Slotted head screwdriver with plastic handle

Acciaio Cr. V.
Lama nichelata



410 102	4x100 mm	410 106	6x125 mm
410 103	5x100 mm	410 107	6x150 mm
410 104	5x125 mm	410 108	8x150 mm

Giravite a lama per meccanici impugnatura in acetato di cellulosa nero

Slotted head screwdriver with plastic handle

Acciaio Cr. V.
Lama nichelata



410 111	3x75 mm	410 114	4x100 mm
---------	---------	---------	----------

Giravite a croce phillips impugnatura in acetato di cellulosa

Phillips screwdriver with plastic handle

Acciaio Cr. V.
Lama nichelata



410 120	3 - 0x60 mm	410 123	6 - 2x100 mm
410 121	4.5 - 1x80 mm		

Giravite nano a lama per meccanica impugnatura in acetato di cellulosa

Short slotted head screwdriver with plastic handle

Acciaio Cr. V.
Lama nichelata



410 130	4x30 mm
---------	---------

Giravite nano a croce per meccanica impugnatura in acetato di cellulosa

Short slotted head screwdriver with plastic handle

Acciaio Cr. V.
Lama nichelata



410 132	Diam. 4 mm - 1x30 mm
---------	----------------------

Serie di giraviti impugnatura in materiale bi plastico

Set of screwdrivers with bi plastic handle

Acciaio Cr. V.
Lama nichelata



410 136	3x75-4x100-5x100-6x125 PH 1x80-2x100 - 6 pcs
410 137	3x75-4x100-5x100-6x125-8x150 PH 0x60-1x80-2x100 N 5x30 PHN 5x30 - 10 pcs

Estrattore perni ganasce freni

Mini kit for electrician



410 150	416 002 - 416 612 - 410 111 - 410 114 - 410 121-410 330
---------	---

Astuccio giraviti di precisione

Set of precision screwdriver



410 301	1-1.5-2-3 PH 00 - PH 0
---------	------------------------

Astuccio giraviti di precisione

Set of precision screwdriver



410 302	1-1.5-2-2.5-3-4 Taglio
---------	------------------------

Astuccio giraviti di precisione

Set of precision screwdriver



410 303	PH 00 - PH 1 Esagono 1,5 - 2 - 2,5
---------	------------------------------------

Giravite Phillips albero flessibile

Flexible blade Philips screwdriver

Acciaio Cr. V.
Lama nichelata



410 308 PH 1

410 309 PH 2

Astuccio con 21 giraviti taglio e croce e chiavi a bussola

Set of precision screwdriver



410 310

Astuccio con chiavi a bussola

Mini socket set



410 315 2 - 3 - 4 - 4,5 - 5 mm

Microcacciavite intercambiabile con Led

Made in Germany



410 318

Composizione - Composition



- Punta taglio lama mm 1,6
- Punta taglio croce Ø 0
- Punta Tx 5 = Punta Esagono 1.3
- Punta Tx 6 = Punta Esagono 1.5

Giravite cercafase

Fase detecting screwdriver



410 330 3x60 mm 100-500 Volt

410 331 4x100 mm 100-500 Volt

Giravite provacircuito auto

Car voltage detecting screwdriver



410 335 6-12 Volt

Giravite provacircuito auto con punta a penetrazione e cappuccio di protezione

Car voltage detecting screwdriver



410 340 Acciaio - 6-12 Volt

Inserto per attacco universale da 1/4" a taglio

Bits for slotted screw, hexagon drive 1/4"

Acciaio Mo.V.
HRC 60-62



411 001 3x25 mm

411 005 6x25 mm

411 002 4x25 mm

411 006 8x25 mm

411 004 5x25 mm

411 007 10x25 mm

Inserto per attacco universale da 1/4" a taglio

Bits for slotted screw, hexagon drive 1/4"

Acciaio Mo.V.
HRC 60-62

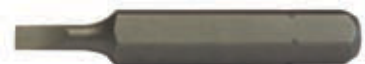

411 011 3x40 mm

411 014 6x40 mm

411 012 4x40 mm

411 015 8x40 mm

411 013 5x40 mm

411 016 10x40 mm

Inserto per attacco universale da 1/4" a croce Phillips

Bits for slotted screw, hexagon drive 1/4"

Acciaio Mo.V.
HRC 60-62



411 021 0x25 mm

411 023 2x25 mm

411 022 1x25 mm

411 024 3x25 mm

Inserto per attacco universale da 1/4" a croce pozidrive

Bits for slotted screw, pozidrive drive 1/4"

Acciaio Mo.V.
HRC 60-62



411 031	1x25 mm	411 033	3x25 mm
411 032	2x25 mm		

Inserto con attacco universale da 1/4" per viti con esagono incassato forato

Bits for hollow hexagon screw with hole, drive 1/4"

Acciaio US12
HRC 60-62



411 035	2 mm	411 038	4 mm
411 036	2,5 mm	411 039	5 mm
411 037	3 mm	411 040	6 mm

Inserto per attacco universale da 1/4" per viti esagono incassato

Bits for hollow hexagon screw, philips drive 1/4"

Acciaio Mo.V.
HRC 60-62



411 041	2x25 mm	411 044	4x25 mm
411 042	2.5x25 mm	411 045	5x25 mm
411 043	3x25 mm	411 046	6x25 mm

Inserto per attacco universale da 1/4" per viti Torx

Bits for Torx screw, hexagon drive 1/4"

Acciaio Mo.V.
HRC 60-62



411 051	T 6x25 mm	411 057	T 20x25 mm
411 052	T 7x25 mm	411 058	T 25x25 mm
411 053	T 8x25 mm	411 059	T 27x25 mm
411 054	T 9x25 mm	411 060	T 30x25 mm
411 055	T 10x25 mm	411 061	T 40x25 mm
411 056	T 15x25 mm		

Inserto per attacco universale da 1/4" per viti Torx

Bits for Torx screw, hexagon drive 1/4"

Acciaio Mo.V.
HRC 60-62



411 073	T 8x40 mm	411 078	T 25x40 mm
411 074	T 9x40 mm	411 079	T 27x40 mm
411 075	T 10x40 mm	411 080	T 30x40 mm
411 076	T 15x40 mm	411 081	T 40x40 mm
411 077	T 20x40 mm		

Inserto per attacco universale da 1/4" per viti Torx

Bits for Torx screw, hexagon drive 1/4"

Acciaio US12
HRC 60-62



411 085 06	6x25 mm	411 085 10	10x25 mm
411 085 08	8x25 mm	411 085 14	1/4"x28 mm

Inserto con attacco universale da 1/4" per viti Tree Wing

Bits for hollow Tree wing screw, drive 1/4"

Acciaio US12
HRC 60-62



411 086 01	1x25 mm	411 086 03	3x25 mm
411 086 02	2x25 mm	411 086 04	4x25 mm

Inserto con attacco universale da 1/4" per viti Spanner

Bits for hollow Spanner screw, drive 1/4"

Acciaio US12
HRC 60-62



411 087 04	4x25 mm	411 087 08	8x25 mm
411 087 06	6x25 mm	411 087 10	10x25 mm

Inserto con attacco universale da 1/4" per viti Square

Bits for hollow Square screw, drive 1/4"

Acciaio US12
HRC 60-62



411 088 00	0x25 mm	11 088 02	2x25 mm
411 088 01	1x25 mm	411 08803	3x25 mm

Inserto per attacco universale da 1/4" per viti Torx con foro

Bits for Torx hole screw, hexagon drive 1/4"

Acciaio Mo.V.
HRC 60-62



411 091	T 6X25 mm	411 097	T 20x25 mm
411 092	T 7X25 mm	411 098	T 25x25 mm
411 093	T 8x25 mm	411 099	T 27x25 mm
411 094	T 9x25 mm	411 100	T 30x25 mm
411 095	T10x25 mm	411 101	T 40x25 mm
411 096	T15x25 mm		

Inserti con attacco universale da 1/4" Pentatorx forati

Acciaio S2



411 102 08	TS 08x25	411 102 27	TS 27x25
411 102 10	TS 10x25	411 102 30	TS 30x25
411 102 15	TS 15x25	411 102 40	TS 40x25
411 102 20	TS 20x25	411 102 45	TS 45x25
411 102 25	TS 25x25	411 102 50	TS 50x25

Inserti con attacco universale da 1/4" Spline - XZN

Acciaio S2



411 103 04	M 4x25	411 103 08	M 8x25
411 103 05	M 5x25	411 103 10	M 10x25
411 103 06	M 6x25		

Inserto con attacco universale da 1/4" con grip

Acciaio Mo.V. HRC 60-62



411 104 03	Taglio - 3 x 25 mm
411 104 04	Taglio - 4 x 25 mm
411 104 05	Taglio - 5 x 25 mm
411 104 06	Taglio - 5.5 x 25 mm
411 104 07	Taglio - 6.5 x 25 mm

Inserto con attacco universale da 1/4" con grip

Acciaio Mo.V. HRC 60-62



411 105 00	Phillips - 0 x 25 mm
411 105 01	Phillips - 1 x 25 mm
411 105 02	Phillips - 2 x 25 mm
411 105 03	Phillips - 3 x 25 mm

Inserto con attacco universale da 1/4" con grip

Acciaio Mo.V. HRC 60-62



411 106 00	Pozidriv - 0 x 25 mm
411 106 01	Pozidriv - 1 x 25 mm
411 106 02	Pozidriv - 2 x 25 mm
411 106 03	Pozidriv - 3 x 25 mm

Box inserti da 1/4" e portainseriti magnetico

1/4" Bits in box



411 107 Pz 12

Composizione - Composition

	mm 4 - Pz 1	mm 5 - Pz 1	mm 6 - Pz 1
	Pz 1 - Pz 1	Pz 2 - Pz 1	
	Ph 1 - Pz 1	Ph 2 - Pz 1	Ph 3 - Pz 1
	Es 4 - Pz 1	Es 5 - Pz 1	Es 6 - Pz 1
Porta inserti magnetico			Pz 1



www.afasupport.it

Box inserti da 1/4" e portainseriti a sgancio rapido

1/4" Bits in box with magnetic quick-release holder



411 108 Pz 11

Composizione - Composition

 mm 5.5 - mm 6.5 Pz 2

 PZ 0 - PZ 1 - PZ 2 - PZ 3 Pz 4

 PH 0 - PH 1 - PH 2 - PH 3 Pz 4

Porta inserti magnetico Pz 1

Box inserti da 1/4" e portainseriti a sgancio rapido

1/4" Bits in box with magnetic quick-release holder



411 109 Pz 30

Composizione - Composition

 mm 4 - Pz 2 mm 5.5 - Pz 5 mm 6.5 - Pz 5

 Pz 1 - Pz 2 Pz 2 - Pz 5 Pz 3 - Pz 3

 Ph 1 - Pz 2 Ph 2 - Pz 5 Ph 3 - Pz 3

Porta inserti magnetico Pz 2

Set inserti 1/4x25 taglio con adattatore portainseriti con quadro 1/4

Kit 1/4x25 with adaptor



411 110 3-4-5-6-6-8-10 1/4" M-F 8 Pz

Set inserti 1/4x25 Ph-Pzd con adattatore portainseriti con quadro 1/4

Kit Ph-Pzd 1/4x25 with adaptor



Acciaio Mo.V.
HRC 60-62

411 111 Ph 0-1-2-3 PZD 1-2-3 8 Pz

Set inserti 1/4x25 torx con adattatore portainseriti con quadro 1/4

Kit Torx 1/4x25 with adaptor



Acciaio Mo.V.
HRC 60-62

411 112 T10-15-20-25-27-30-40 1/4" M-F 8 Pz

411 113 TH10-15-20-25-27-30-40 1/4" M-F 8 Pz

Set inserti 1/4x25 Penta-torx forati con adattatore portainseriti con quadro 1/4

Kit Penta-Torx 1/4x25 with adaptor



Acciaio Mo.V.
HRC 60-62

411 114 TH10-15-20-25-27-30-40 8 Pz

Cricchetto per inserti da 1/4"

Ratchet for bits 1/4"

411 115



Set inserti 1/4 Torx con minicricchetto reversibile

Bits Torx set with reversible ratchet



Acciaio Mo.V.
HRC 60-62

411 117 11 Pz.



Composizione - Composition

- 7 Inserti torx da T10 a T40
- 2 Inserti PH 1-2
- 1 Inserto Taglio 6mm
- 1 Minicricchetto 1/4x25

Set inserti Torx forato 1/4 con minicricchetto reversibile

Set Torx bits Torz with hole 1/4 with mini-ratchet



Acciaio Mo.V.
HRC 60-62



411 118 11 Pz.

Composizione - Composition

- 7 Inserti torx forati da T10 a T40
- 2 Inserti PH 1-2
- 1 Inserto Taglio 6mm
- 1 Minicricchetto 1/4x25

Set inserti 1/4 penta-torx forati con minicricchetto

Bits 1/4 penta torx with hole and mini-ratchet



Acciaio Cr.M..



411 119 10 Pz.

Composizione - Composition

- 7 Inserti torx da T10 a T40
- 1 Minicricchetto 1/4x25.

Set bussole Pentagonali forato

Set pentagonal socket perforated torx



1/4"



411 121 Pz. 7

Composizione - Composition

	Att.	TS
411 121 10	1/4"	10
411 121 15	1/4"	15
411 121 20	1/4"	20
411 121 25	1/4"	25
411 121 27	1/4"	27
411 121 30	1/4"	30
411 121 40	1/4"	40

Bussole con inserto pentagonale forato

Socket with pentagonal bits

Acciaio Molibdeno - HRC 60-62

Att:



TS



1/4"

	Att.	TS
411 121 10	1/4"	10
411 121 15	1/4"	15
411 121 20	1/4"	20
411 121 25	1/4"	25
411 121 27	1/4"	27
411 121 30	1/4"	30
411 121 40	1/4"	40
411 121 45	1/4"	45
411 121 50	1/4"	50

3/8"

	Att.	TS
411 122 45	3/8"	45
411 122 50	3/8"	50
411 122 55	3/8"	55

Set bussole 1/4" & 3/8" con inserto Torx femmina

1/4" & 3/8" DR. star bit socket set

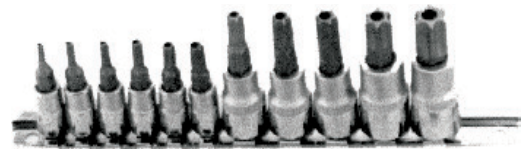

411 125 11 Pz.

Composizione - Composition

- 1/4" (T10H, T15H, T20H, T25H, T27H, T30H)
- 3/8" (T40H, T45H, T50H, T55H, T60H)

Adattatore con albero flessibile F - M

Flexible extension bar

Att. F.



Att. M.

mm 300

	Att. F.	Att. M
411 135	1/4"	1/4"
411 136	3/8"	3/8"

Adattatore con albero flessibile con quadro 1/4 M-F

Flexible adaptor



411 139 mm 145

Prolunga flessibile maschio femmina 1/4x145

Flexible adaptor male female 1/4x145



411 140 Att. Es. M 1/4 - quadroF 1/4

Portainseri magnetico con attacco rapido da 1/4"



411 141 Bussola A-magnetica 1/4" F

Mandrino con attacco rapido 1/4

Clutch with rapid attack 1/4"



411 142 1/4" M/F

NOTE



Valigetta inserti - portainseri da 1/4"

1/4" Bits in box



411 143 Pz 103

Composizione - Composition

-  **Taglio mm 4 - 5 - 6 con grip** Pz 9
-  **Ph. n° 1 - 2 - 3 con grip** Pz 9
-  **Pzd. n° 1 - 2 - 3 con grip** Pz 9
-  **Tx. T 6 - 8 - 10 - 15 - 20 - 25 - 27 - 30 - 40** Pz 18
-  **Tx. forato T 6 - 8 - 10 - 15 - 20 - 25 - 27 - 30 - 40** Pz 18
-  **Penta Tx forato T 10 - 15 - 20 - 25 - 27 - 30 - 40** Pz 7
-  **Esag. mm 2 - 3 - 4 - 5 - 6** Pz 10
-  **Esag. forato mm 2 - 2,5 - 3 - 4 - 5 - 6** Pz 5
-  **Torq mm 6 - 8 - 10 - 1/4"** Pz 4
-  **Tri-Wing n° 1 - 2 - 3 - 4** Pz 4
-  **Spanner forati 4 - 6 - 8 - 10** Pz 4
-  **Quadro 1 - 2 - 3 - 4** Pz 4

Porta inserti magnetico 411 370 Pz 1
Porta inserti innesto rapido 411 141 Pz 1

Confezione 33 inserti di sicurezza da 1/4

Kit 33 security bits

**Acciaio US12
HRC 60±62**



- 411 145 6 ex mm 2 - 2.5 - 3 - 4 - 5 - 6
- 6 ex 5/32 - 9/64 - 1/8 - 7/64 - 3/32 - 5/64
- 9 torx T8 - 10 - 15 - 20 - 25 - 27 - 30 - 35 - 40
- 4 forcella 4 - 6 - 8 - 10
- 4 croce tre lati 1 - 2 - 3 - 4
- 3 croce quattro lati 6 - 8 - 10

Confezione 31 pezzi inserti 1/4 Esagonale, Taglio, Phillips, PZDrive, Torx, Esagonale metrico e pollice

Bits set

**Acciaio US12
HRC 60-62**



411 146 Box in materiale plastico

Set 17 Pz. in cassetta metallica inserti 1/4 torx forati normali e penta Torx

Bits set

**Acciaio US12
HRC 60-62**



411 147 Box metallico

Composizione - Composition

- 411 113 - 7 Torx Forato da T10 a T40
- 411 114 - 7 PentaTorx da T10 a T40
- 1 Cricchetto reversibile
- 1 Mandrino Quick change magnetico
- 1 Adattatore quadro 1/4" F 1/4 es

411 147 01 SOLO PENTA TORX FORATO

411 147 02 SOLO TORX FORATO

Cassetta metallica 43 pz. inserti 1/4x30 - 1/4x50

Kit 43 bits

**Acciaio US12
HRC 60-62**



411 148

Composizione - Composition

- Inserti taglio: 3-4-5-5,5-6-7
- Inserti Phillips: 0-1-2-3
- Inserti esagonali: 2-2,5-3-4-5-6
- Inserti torx: 8-10-15-20-25-27-30-40
- Impugnatura esagonale F 1/4"
- Adattore M1/4"-F1/4"
- Adattore F1/4"-F3/8"

Confezione inserti di sicurezza 1/4" con impugnature

Kit security bits with handle

**Inserti Acc. S2
HRC 60-62**



411 149 30 Pz.

Composizione - Composition

- Torx Forati: TH 08-10-15-20-25-27-30-35-40
- Forchetta: mm 3,5-4-5-6
- Esagono Forato: 5/64-3/32-7/64-1/8-9/64-5/32
- Croce Disassata: mm 6-8-10
- Tre Lati: mm 2-3-4
- Adattatore: F- 1/4"x es.1/4"
- Adattatore: M- 1/4"x es.1/4"

Portainseri magnetico 1/4

Hands inserts magnetic 1/4



411 151 mm 220x120 f.m.

411 152 mm 400x280 f.m.

Chiave bussola a tre teste magnetica per inserti da 1/4"

411 158

145

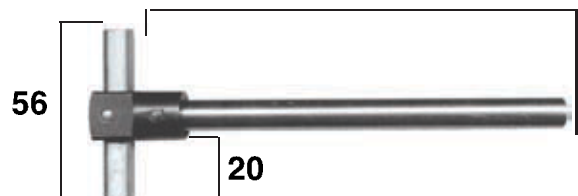

Portainseri magnetico albero flessibile

Flexible blade magnetic bit holder



411 161 1/4" - lama mm 160

Portainseri albero flessibile alta resistenza

Hands inserts tree flexible tall resistance



411 163 1/4"

411 164 5/16"

Adattatore porta bussole albero flessibile

Flexible blade socket driver



411 165 01 Albero flessibile rigido - 1/4"

Impugnatura con quadro maschio da 1/4"



411 166

Impugnatura con snodo con quadro maschio da 1/4"

Flexible blade magnetic bit holder

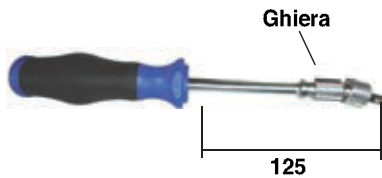

411 167 mm 245

Ghiera su albero filettato per blocco snodo.

Impugnatura con snodo con quadro femmina da 1/4"

Flexible blade magnetic bit holder



411 168 mm 245

Ghiera su albero filettato per blocco snodo.

Kit cacciavite con rinvio angolare 90° con inserti a taglio e croce

Angled screwdriver with bits set

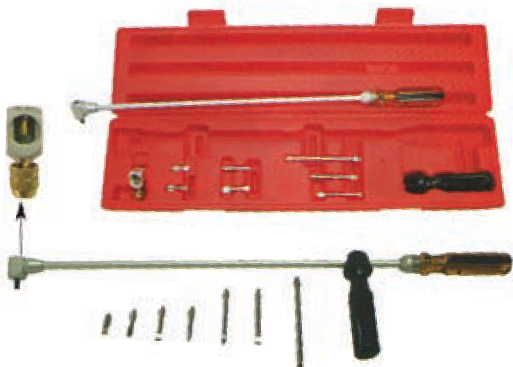

411 170 Per Moto

Avvitatore manuale con rinvio 90° att.esag.1/4"

Manual angled ratchet 90° 1/4"

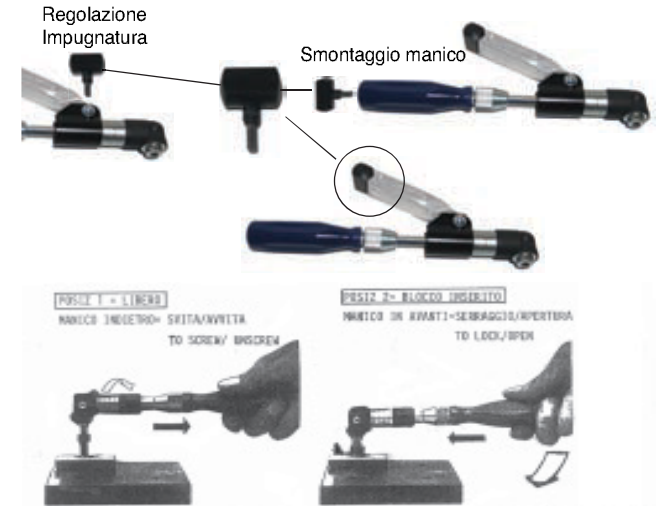

411 175

Inserto per avvitatore elettrico o pneumatico da 1/4" a taglio

Bits for slotted screw, hexagon drive 1/4" for electric and pneumatic tools

Acciaio Mo.V. HRC 60-62

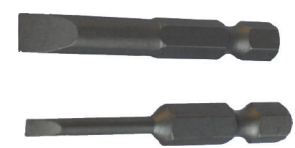

411 201	3x50 mm	411 205	6x50 mm
411 202	4x50 mm	411 206	6,5x50 mm
411 203	4.5x50 mm	411 207	7x50 mm
411 204	5x50 mm	411 208	8x50 mm

Inserto per avvitatore elettrico o pneumatico da 1/4" a croce phillips

Bits for philips screw, hexagon drive 1/4" for electric and pneumatic tools

Acciaio Mo.V. HRC 60-62



411 211	0x50 mm	411 213	2x50 mm
411 212	1x50 mm	411 214	3x50 mm

Inserto per avvitatore elettrico o pneumatico da 1/4" a croce phillips

Bits for phillips screw, hexagon drive 1/4" for electric and pneumatic tools

Acciaio Mo.V.
HRC 60-62

TORNITO



411 221	0x50 mm	411 223	2x50 mm
411 222	1x50 mm	411 224	3x50 mm

Inserto per avvitatore elettrico o pneumatico da 1/4" a croce phillips

Bits for phillips screw, hexagon drive 1/4" for electric and pneumatic tools

Acciaio Mo.V.
HRC 60-62

TORNITO



411 242	Ph 1x100 mm	411 243	Ph 2x100 mm
---------	-------------	---------	-------------

Inserto per avvitatore elettrico o pneumatico da 1/4" a croce pozidrive

Bits for pozidrive screw, hexagon drive 1/4" for electric and pneumatic tools

Acciaio Mo.V.
HRC 60-62

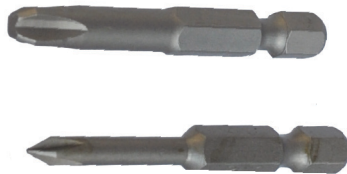

411 251	1x50 mm	411 253	3x50 mm
411 252	2x50 mm		

Inserto per avvitatore elettrico o pneumatico da 1/4" a croce pozidrive tornito

Bits for pozidrive screw, hexagon drive 1/4" for electric and pneumatic tools

Acciaio Mo.V.
HRC 60-62

TORNITO

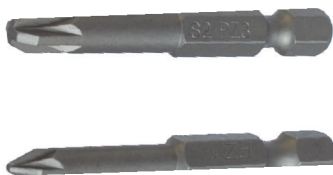

411 261	1x50 mm	411 263	3x50 mm
411 262	2x50 mm		

Inserto per avvitatore elettrico o pneumatico da 1/4" a croce pozidrive tornito

Bits for pozidrive screw, hexagon drive 1/4" for electric and pneumatic tools

Acciaio Mo.V.
HRC 60-62

TORNITO



411 282	1x100 mm	411 283	2x100 mm
---------	----------	---------	----------

Inserto per avvitatore elettrico o pneumatico da 1/4" per viti esagoni incassato

Bits for hollow hexagon screw, hexagon drive 1/4" for electric and pneumatic tools

Acciaio Mo.V.
HRC 60-62

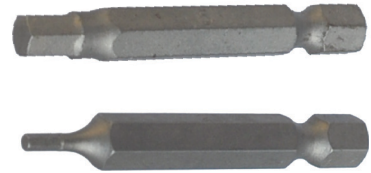

411 301	2x40 mm	411 311	2x50 mm
411 302	2.5x40 mm	411 312	2.5x50 mm
411 303	3x40 mm	411 313	3x50 mm
411 304	4x40 mm	411 314	4x50 mm
411 305	5x40 mm	411 315	5x50 mm
411 306	6x40 mm	411 316	6x50 mm

Inserto per avvitatore elettrico o pneumatico da 1/4" per viti Torx

Bits for torx screw, hexagon drive 1/4" for electric and pneumatic tools

Acciaio Mo.V.
HRC 60-62



411 321	T 10x50 mm	411 325	T 27x50 mm
411 322	T 15x50 mm	411 326	T 30x50 mm
411 323	T 20x50 mm	411 327	T 40x50 mm
411 324	T 25x50 mm		

Inserto per avvitatore elettrico o pneumatico da 1/4" a croce pozidrive e philips

Bits for pozidrive and philips screw, hexagon drive 1/4" for electric and pneumatic tools

Acciaio Mo.V.
HRC 60-62



411 341	1x60 mm	411 343	3x60 mm
411 342	2x60 mm		

Adattatore Maschio per bussole 1/4"

Adaptor male 1/4"

Cromo Vanadio



411 360	Es.M 1/4"xquadro M 1/4"
---------	-------------------------

Adattatori con esagono maschio da mm 8

Adaptor hex mm 8

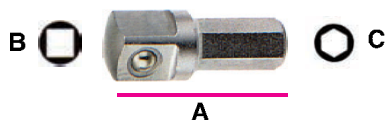

	A	B	C
411 360 01	mm 30	3/8"	mm 8
411 360 02	mm 30	1/2"	mm 8

Adattatore con quadro per bussole per avvitatore elettrico o pneumatico

Square for sockets for electric and pneumatic tools



411 361	1/4" x60 mm
411 362	3/8" x60 mm

Porta inserti magnetico attacco 1/4-5/16 per avvitatore elettrico o pneumatico

Magnetic bit holder for electric and pneumatic tools

Cromo Vanadio

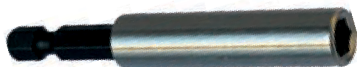

411 370	magnetico c/anello ritegno - 1/4" x60 mm
411 371	magnetico c/anello ritegno - 1/4" x75 mm
411 373	magnetico - 5/16"x 55 mm

Bussola esagonale magnetica per dadi con attacco 1/4" per avvitatore elettrico o pneumatico

Magnetic socket for electric and pneumatic tools

Acciaio Mo.V.
HRC 60-62



411 382	6 mm	411 387	11 mm
411 383	7 mm	411 388	12 mm
411 384	8 mm	411 389	13 mm
411 386	10 mm		

NOTE



Inserti Torx con attacco universale da 5/16"

Screwdriver blade for Torx screws - 5/16"



CORTI

411 390 15	Tx 15 x mm 30	411 390 40	Tx 40 x mm 30
411 390 20	Tx 20 x mm 30	411 390 45	Tx 45 x mm 30
411 390 25	Tx 25 x mm 30	411 390 50	Tx 50 x mm 30
411 390 27	Tx 27 x mm 30	411 390 55	Tx 55 x mm 30
411 390 30	Tx 30 x mm 30	411 390 60	Tx 60 x mm 30

LUNGI

411 391 20	Tx 20 x mm 75	411 391 40	Tx 40 x mm 75
411 391 25	Tx 25 x mm 75	411 391 45	Tx 45 x mm 75
411 391 27	Tx 27 x mm 75	411 391 50	Tx 50 x mm 75
411 391 30	Tx 30 x mm 75		

Inserto per viti esagonali, attacco esagonale 10 mm

Screwdriver blade for hollow hexagon with hole screws hexagon drive 10mm

Acciaio US12
HRC 60-62



411 401	4x30 mm	411 405	8x30 mm
411 402	5x30 mm	411 406	10x30 mm
411 403	6x30 mm	411 407	12x30 mm
411 404	7x30 mm		

Inserto lungo per viti esagonali con attacco esagonale da 10 mm

Screwdriver blade for hollow hexagon with hole screws hexagon drive 10mm

Acciaio US12
HRC 60-62



411 411	4x75 mm	411 415	8x75 mm
411 412	5x75 mm	411 416	10x75 mm
411 413	6x75 mm	411 417	12x75 mm
411 414	7x75 mm		

Inserto per viti TORX corto con attacco esagonale da 10 mm

Screwdriver blade for Torx screw Hexagon drive 10mm

Acciaio US12
HRC 60-62



411 421	T 10X30	411 426	T 30X30
411 422	T 15X30	411 428	T 45X30
411 423	T 20X30	411 429	T 50X30
411 424	T 25X30	411 430	T 55X30
411 425	T 27X30	411 431	T 60X30
411 427	T 40X30		

Inserto per viti Torx lungo con attacco esagonale da 10 mm

Screwdriver blade for Torx screws Hexagon drive 10mm

**Acciaio US12
HRC 60-62**



411 441	T 10x75 mm	411 447	T 40x75 mm
411 442	T 15x75 mm	411 448	T 45x75 mm
411 443	T 20x75 mm	411 449	T 50x75 mm
411 444	T 25x75 mm	411 450	T 55x75 mm
411 445	T 27x75 mm	411 451	T 60x75 mm
411 446	T 30x75 mm		

Inserto per viti Torx forato con attacco esagonale da 10 mm

Screwdriver blade for Torx with hole screws Hexagon drive 10mm

**Acciaio US12
HRC 60-62**



411 461	T 10x38 mm	411 467	T 40x30 mm
411 462	T 15x30 mm	411 468	T 45x30 mm
411 463	T 20x30 mm	411 469	T 50x30 mm
411 464	T 25x30 mm	411 470	T 55x30 mm
411 465	T 27x30 mm	411 471	T 60x30 mm
411 466	T 30x30 mm		

Inserto per viti Torx lungo forato con attacco esagonale da 10 mm

Screwdriver blade for Torx with hole screws Hexagon drive 10mm

**Acciaio US12
HRC 60-62**



411 481	T 10x75 mm	411 487	T 40x75 mm
411 482	T 15x75 mm	411 488	T 45x75 mm
411 483	T 20x75 mm	411 489	T 50x75 mm
411 484	T 25x75 mm	411 490	T 55x75 mm
411 485	T 27x75 mm	411 491	T 60x75 mm
411 486	T 30x75 mm		

Inserto per viti XZN con attacco esagonale da 10 mm

Screwdriver blade for XZN nuts with hole screws Hexagon drive 10mm

**Acciaio US12
HRC 60-62**



411 502	5x30 mm	411 505	10x30 mm
411 503	6x30 mm	411 506	12x30 mm
411 504	8x30 mm		

Inserto per viti XZN lungo con attacco esagonale da 10 mm

Screwdriver blade for XZN screws Hexagon drive 10mm

**Acciaio US12
HRC 60-62**



411 512	5x75 mm	411 515	10x75 mm
411 513	6x75 mm	411 516	12x75 mm
411 514	8x75 mm		

Inserto per viti RIBE con attacco esag. da 10 mm

Screwdriver blade for RIBE screws Hexagon drive 10mm

**Acciaio US12
HRC 60-62**



411 529	M04x30	411 535	M10x30
411 530	M05x30	411 536	M11x30
411 531	M06x30	411 537	M12x30
411 532	M07x30	411 538	M13x30
411 533	M08x30	411 539	M14x30
411 534	M09x30		

Inserto per viti RIBE con attacco esag. da 10 mm

Screwdriver blade for RIBE screws Hexagon drive 10mm

**Acciaio US12
HRC 60-62**



411 540 00	M04x75	411 545	M10x75
411 540	M05x75	411 546	M11x75
411 541	M06x75	411 547	M12x75
411 542	M07x75	411 548	M13x75
411 543	M08x75	411 549	M14x75
411 544	M09x75		

Inserto per viti RIBE con attacco esag. da 10 mm

Screwdriver blade for RIBE screws Hexagon drive 10mm

**Acciaio US12
HRC 60-62**



411 550	M05x40	411 573	M08x75
411 551	M06x40	411 574	M09x75
411 552	M07x40	411 575	M10x75
411 553	M08x40	411 576	M11x75
411 554	M09x40	411 577	M12x75
411 555	M10x40	411 578	M13x75
411 557	M12x40	411 579	M14x75
411 572	M07x75		

Bussola porta inserti

Socket for bits



- 411 750 Es.F 1/4"xquadro F 1/4"
- 411 750 02 Es.F 1/4"xquadro F 3/8"
- 411 750 04 Es.F 1/4"xquadro F 1/2"
- 411 751 Es.F 5/16"xquadro F 3/8"
- 411 752 Es.F 5/16"xquadro F 1/2"
- 411 755 Es.F 10 xquadro F 3/8"
- 411 756 Es.F 10 xquadro F 1/2"

Cacciavite a percussione con bits

Impact driver



- 411 761 Cacciavite con Bits
- 411 762 Serie 4 lame ric/ Set 4 blade /Set de 4 bits - 5/16"

Inserto per attacco universale da 5/16" a croce Phillips

Bits for slotted screw, philips drive 1/4"

Acciaio US12
HRC 60-62



- 411 802 2x32 mm 411 804 4x32 mm
- 411 803 3x32 mm

Inserto per attacco universale da 5/16" a Taglio

Bits for slotted screw, drive 5/16"

Acciaio Mo.V.
HRC 60-62



- 411 810 8x1,2x40 mm 411 812 9x1,6x36 mm
- 411 811 9x1,4x36 mm

Confezione doppia inserti Torx forato 1/4"

Double set Torx bit 1/4"



- 411 902 2x T8-T9-T10-T15-T20-T25-T30-T40

Confezione inserti Torx forato 1/4" con impugnatura a pipa

Torx set 1/4"

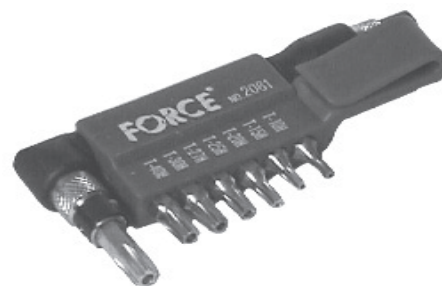

- 411 904 T10-T15-T20-T25-T27-T30-T40

Blister con 6 inserti e porta inserti magnetico 75 mm - Ph1-Ph2-Pzd1-Pzd2-Tgl4-Tgl6



- 411 905 Porta Inserti Att. 1/4"x75 - 5/16"x75
2 PH-2 PZ-2
Lama 411 371 + 411 373
- 411 906 2 PH-2 PZ-2
Lama 411 371 - Att. 1/4"x75
- 411 907 2 PH-2 PZ-2
Lama 411 373 - Att. 5/16"

Confezione 55 utensili 1/4"

Set of bits 55 pcs 1/4"

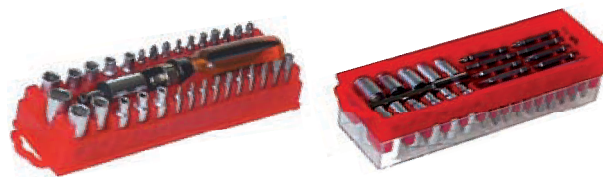

- 411 908

Punte taglio Philips Torx Pozidrive esagonali
Bussole mm e pollici, prolunga e impugnatura a cricchetto reversibile

*Bits slotted, Philips, Torx, Pozidrive, exagonal
Socket on mm and Poll. Extension and reversible handle*

Confezione con 6 inserti 1/4" e porta inserti magnetico per trapano

Set of bits 1/4" for drill

Acciaio US12
HRC 60-62



- 411 915

Confezione con 8 inserti e porta inserti un bulino e 13 punte da trapano

Set of bits for drill and drills



411 920 Bit 2 PH- 2Torx- 2 lama - Punta 1,5-6.5

Confezione inserti esagonali con attacco esagonale 10 mm e bussola da 1/2"

Set of hollow hexagon bits exagonal drive 10 mm and 1/2" socket

Acciaio US12
HRC 60-62



411 923 15 pcs

Confezione inserti Torx attacco esagonale 10 mm e bussola da 1/2"

Set of Torx bits exagonal drive 10 mm and 1/2" socket

Acciaio US12
HRC 60-62



411 925 15 pcs

Confezione inserti XZN attacco esagonale mm 10 e bussola con attacco da 1/2"

Set of XZN bits exagonal drive 10 mm and 1/2" socket

Acciaio US12
HRC 60-62



411 927 11 pcs

Confezione inserti Torx-Esagonali-XZN con attacco da 10 mm corti e lunghi con bussole di guida da 1/2" e 3/8"

Set of Torx Exag XZN exagonal drive 10 mm and 1/2"-3/8" socket drive



411 928 T20-T25-T27-T30-T40-T45-T50-T55 - 30 e 75 mm
4-5-6-7-8-9-10-11-12 - 30 e 75 mm-XZN 4-5-6-8-10-12 - 30 e 75 mm

Confezione inserti Torx-Esagonali-XZN con attacco da 10 mm corti e lunghi con bussole di guida da 1/2" e 3/8"

Set of Torx Exag XZN exagonal drive 10 mm and 1/2"-3/8" socket drive

Acciaio US12
HRC 60-62



411 929 T20-T25-T27-T30-T40-T45-T50-T55 - 30 e 75 mm
4-5-6-7-8-9-10-11-12 - 30 e 75 mm
XZN 4-5-6-8-10-12 - 30 e 75 mm

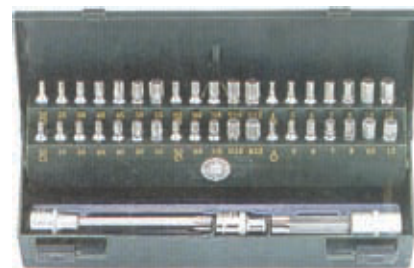

Confezione di inserti corti e lunghi con attacco da mm 10, due portainseriti + due bussole con inserto

44pc bit set



411 929 10 In valigetta - Pz 44

Composizione - Composition

-  Es: mm 4 - 5 - 6 - 7 - 8 - 10 - 12 (30 & 75 mm)
-  Tx: 20 - 25 - 30 - 40 - 45 - 50 - 55 - 60 (30 & 75 mm)
-  Xzn: M5 - M6 - M8 - M10 - M12 (30 & 75 mm)

Bussola portainseriti mm 10 con attacco quadro 3/8"
Bussola portainseriti mm 10 con attacco quadro 1/2"

Bussola con inserto Tx 55 lunga mm 140
Bussola con inserto Tx 70 lunga mm 100

Confezione inserti Torx forati con attacco da 10 mm corti e lunghi con bussole di guida 1/2" e 3/8"

Set of Torx with hole bits exagonal drive 10 mm

**Acciaio US12
HRC 60-62**

 22 pz.



411 930 T10-T15-T20-T25-T27-T30-T40-T45-T50-T55
30 mm
T10-T15-T20-T25-T27-T30-T40-T45-T50-T55
75 mm

Confezione inserti ribe con attacco mm 10 corti e lunghi con 2 bussole guida 3/8 e 1/2"

Kit RIBE bits

**Acciaio US12
HRC 60-62**



411 931 M5-6-7-8-9-10-11-12-13-14 22Pz

Confezione inserti ribe con attacco mm 10 corti e lunghi con 2 bussole guida 3/8 e 1/2"

Kit RIBE bits



411 933 M5-6-7-8-9-10-11-12-13-14 22Pz

Confezione inserti ribe con attacco mm 10 corti e lunghi con 2 bussole guida 3/8 e 1/2" Box metallo

Kit RIBE bits

Acciaio US12 HRC 60-62



411 934	M5-6-7-8-9-10-11-12-13-14	14 Pz
411 934 05	Inserto ricambio	5x40mm
411 934 06	Inserto ricambio	6x40mm
411 934 07	Inserto ricambio	7x40mm
411 934 08	Inserto ricambio	8x40mm
411 934 10	Inserto ricambio	10x40mm
411 934 12	Inserto ricambio	12x40mm
411 934 17	Inserto ricambio	7x100mm
411 934 18	Inserto ricambio	8x100mm
411 934 19	Inserto ricambio	9x100mm
411 934 20	Inserto ricambio	10x100mm
411 934 22	Inserto ricambio	12x100mm
411 934 23	Inserto ricambio	13x100mm
411 934 24	Inserto ricambio	14x100mm

Confezione inserti ribe forati attacco mm 10 corti e lunghi con bussoa guida da 1/2" AFA

Kit RIBE bits AFA

Acciaio Mov.



411 935 M5-6-7-8-10-12x40mm
M7-8-9-10-12-13-14x75 14 Pz

Chiave a brugola esagonale

Hexagon keys short

Acciaio C 60 - Nichelate



412 002	1.5 mm	412 011	6 mm
412 003	2 mm	412 012	7 mm
412 004	2.5 mm	412 013	8 mm
412 005	3 mm	412 014	9 mm
412 006	3.5 mm	412 015	10 mm
412 007	4 mm	412 016	11 mm
412 008	4.5 mm	412 020 01	18 mm
412 009	5 mm	412 025	30 mm
412 010	5.5 mm		

Chiave a brugola esagonale lunga

Hexagon keys long

Acciaio C 60 - Nichelate



412 028 12 mm

Chiavi a L esagonali corte

Short exagonal keys

Acciaio Cr. Molibdeno Cromata



412 040	45x14 mm	es. mm 1.5
412 041	50x16 mm	es. mm 2
412 042	56x18 mm	es. mm 2.5
412 043	63x20 mm	es. mm 3
412 044	66x22 mm	es. mm 3.5
412 045	70x25 mm	es. mm 4
412 046	75x26 mm	es. mm 4.5
412 047	80x28 mm	es. mm 5
412 048	85x30 mm	es. mm 5.5
412 049	90x32 mm	es. mm 6
412 050	95x34 mm	es. mm 7
412 051	100x36 mm	es. mm 8
412 052	106x38 mm	es. mm 9
412 053	112x40 mm	es. mm 10
412 054		es. mm 12
412 056		es. mm 14
412 057		es. mm 17
412 058		es. mm 18
412 059		es. mm 19

Chiavi a brugola esagonali extra lunghe

Extra long hexagon keys

Crom Vanadium - Cromata



412 061	1.5x80 mm	412 068	5x115 mm
412 062	2x80 mm	412 070	6x140 mm
412 063	2.5x90 mm	412 072	8x155 mm
412 064	3x100 mm	412 074	10x170 mm
412 066	4x110 mm		

Chiavi a brugola esagonali forate lunghe

Hexagon keys hole

Crom Vanadium - Cromata



412 080	2x100 mm	412 083	4x140 mm
412 081	2,5x112 mm	412 084	5x160 mm
412 082	3x126 mm	412 085	6x180 mm

Serie 9 pz. chiavi a brugola

Set Hexagon keys

Acciaio US12 - HRC 60÷62
Cromato

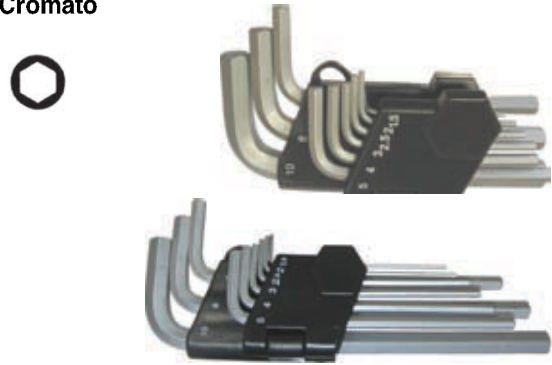

412 092 Corte 1.5 - 2 - 2.5 - 3 - 4 - 5 - 6 - 8 - 10
412 094 Lunghe

Set inserti esagonali snodati con pratica impugnatura rotativa

Made in Germany



412 100 Pz 6

Composizione - Composition

- Esagono 3 x 125 colore oro
- Esagono 4 x 145 colore blu
- Esagono 5 x 155 colore rosso
- Esagono 6 x 175 colore verde
- Esagono 8 x 195 colore giallo
- Esagono 10 x 220 colore nero

Chiave a "T" fissa con 3 estremità maschio Esagonale. Punta brunita da mm 2 a mm 6

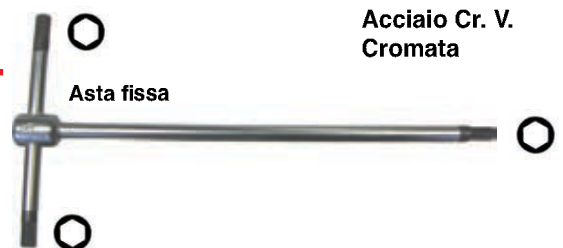

Acciaio Cr. V.
Cromata

Asta fissa

412 112	2	412 116	6
412 112 05	2,5	412 117	7
412 113	3	412 118	8
412 113 05	3,5	412 119	9
412 114	4	412 120	10
412 114 05	4,5	412 121	12
412 115	5	412 121 14	14

Chiavi a T esagonali con asta scorrevole

Slotted head screwdriver with bi plastic handle

Acciaio Cr.V.
Punta Nera

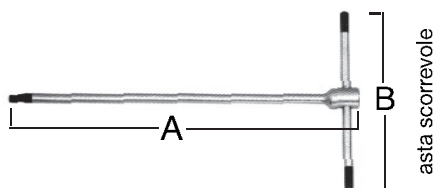

	A	x	B		
412 122	125	x	62	mm	2
412 122 01	125	x	62	mm	2.5
412 123	150	x	75	mm	3
412 123 01	150	x	75	mm	3.5
412 124	180	x	90	mm	4
412 124 01	180	x	90	mm	4.5
412 125	180	x	90	mm	5
412 126	210	x	105	mm	6
412 128	250	x	125	mm	8
412 130	300	x	150	mm	10

Chiave con testa brugola albero flessibile

Nut hexagon keys driver flexible blade



412 141	2 mm	412 146	4.5 mm
412 142	2.5 mm	412 147	5 mm
412 143	3 mm	412 148	6 mm
412 144	3.5 mm	412 149	8 mm
412 145	4 mm		

Cacciavite esagonale testa sferica

Screwdriver hexagonal spherical head



412 193	3x110 mm	412 195	5x140 mm
412 194	4x130 mm	412 196	6x150 mm

Chiave a brugola esagonale testa sferica

Ball head hexagon keys

Cr.V.
Brunita



412 201	1,5 mm	412 206	5 mm
412 202	2 mm	412 207	6 mm
412 203	2,5 mm	412 208	7 mm
412 204	3 mm	412 209	8 mm
412 205	4 mm	412 210	10 mm

Chiavi a T esagonali con asta scorrevole

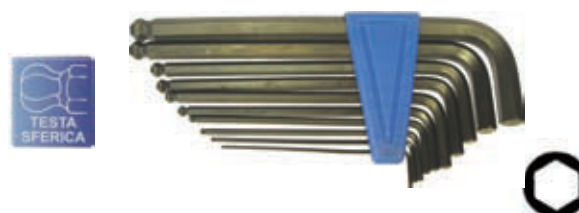

412 245	1.5, 2, 2.5, 3, 4, 5, 6mm	Pz 7
412 246	1.5, 2, 2.5, 3, 4, 5, 6, 8, 10mm	Pz 9

Set chiavi a T esagonali a tre teste incustodia a cerniera

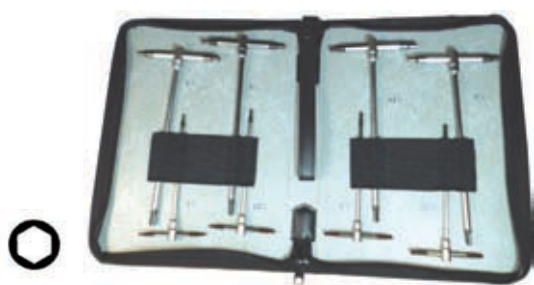

412 135 2, 2.5, 3, 3.5, 4, 4.5, 5, 6 - Pz. 8

Chiave a T con maschio Esagonale snodato

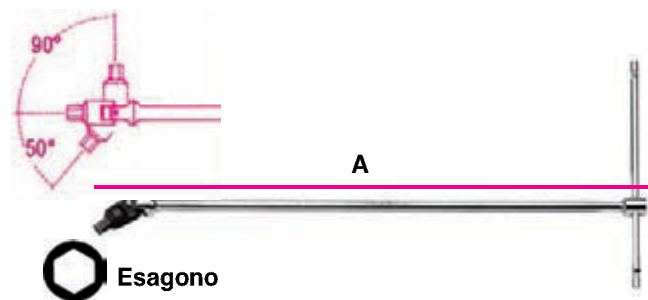

	A	Esagono
412 140 03	394	mm 3
412 140 04	394	mm 4
412 140 05	394	mm 5
412 140 06	401	mm 6
412 140 08	423	mm 8
412 140 10	438	mm 10

Set chiavi a L esagonali extra lunghe testa sferica



412 247 Modello Extra lungo Pz 9
 mm1.5 x 96 - mm2 x 107 - mm2.5 x 120 - mm3 x 135 - mm4 x152 -
 mm5 x173 - mm6 x 194 - mm8 x 212 - mm10 x 232

Chiave a brugola torx

Torx hexagon keys

**Cr.V.
 Brunita**



412 301	T 6	412 308	T 25
412 302	T 7	412 309	T 27
412 303	T 8	412 310	T 30
412 304	T 9	412 311	T 40
412 305	T10	412 312	T 45
412 306	T15	412 313	T 50
412 307	T 20		

Serie chiavi a brugola torx corta

Set of torx hexagon keys

**Cr.V.
 Brunita**



412 314 T10-15-20-25-27-30-40 Pz 7

Serie 9 pz. chiavi a L torx

Set of torx hexagon keys

**Acciaio US12 - HRC 60±62
 Cromato**



412 315	corte T10 - 15 - 20 - 25 - 27 - 30 - 40 - 45 - 50
412 316	lunghe T10 - 15 - 20 - 25 - 27 - 30 - 40 - 45 - 50

Set chiavi a "L" Torx extra lunghe

9 Pcs Extra long type torx

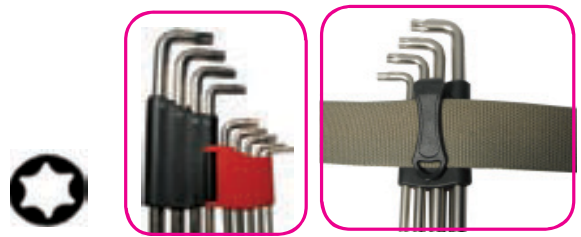

412 316 10 Pz 9

Composizione - Composition

T 10 x 90, T 15 x 100, T 20 x 110, T 25 x 130, T27 x 145, T 30 x 165,
 T 40 x 185, T 45 x 205, T50 x 225

Set chiavi a "L" Torx testa sferica extra lunghe

Extra long ball point torx

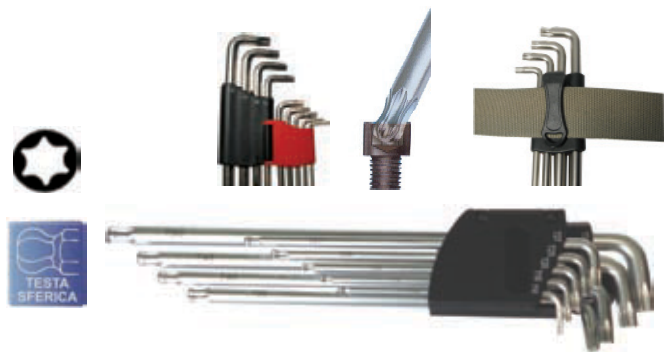

412 317 Pz 9

Composizione - Composition

T 10 x 90, T 15 x 100, T 20 x 110, T 25 x 130, T 27 x 145, T 30 x 165,
 T 40 x 185, T 45 x 205, T50 x 225

Serie 9 pz. chiavi a L torx

Set of torx hexagon keys

**Acciaio Cr. Molibdeno -
 Cromato**



412 318 06	T06x66	412 318 25	T25x100
412 318 07	T07x71	412 318 27	T27x105
412 318 08	T08x76	412 318 30	T30x114
412 318 09	T09x80	412 318 40	T40x124
412 318 10	T10x86	412 318 45	T45x132
412 318 15	T15x90	412 318 50	T50x152
412 318 20	T20x95		

Chiave a L torx forata corta

Short torx keys

Acciaio US12 - HRC 60÷62



412 320	T9	412 324	T25
412 321	T10	412 325	T27
412 322	T15	412 326	T30
412 323	T20	412 327	T40

Chiave a L torx forata lunga

Torx keys long type

Acciaio US12 - HRC 60÷62



412 330	T6	412 337	T25
412 331	T7	412 338	T27
412 332	T8	412 339	T30
412 333	T9	412 340	T40
412 334	T10	412 341	T45
412 335	T15	412 342	T50
412 336	T20		

Serie 9 pz. chiavi a L torx forato

Set torx keys

Acciaio US12 - HRC 60÷62
Cromato



412 345	Corte T10 - 15 - 20 - 25 - 27 - 30 - 40 - 45 - 50
412 346	Lunghe T10 - 15 - 20 - 25 - 27 - 30 - 40 - 45 - 50

NOTE



Giravite Torx, lama cromata, punta nera Impugnatura ergonomica bicomponente

Acciaio Cr. V.



412 365 11 Serie giraviti Torx - Pz 11

Ricambi - Spare parts



412 361 06	T 6	412 361 20	T 20
412 361 07	T 7	412 361 25	T 25
412 361 08	T 8	412 361 27	T 27
412 361 09	T 9	412 361 30	T 30
412 361 10	T 10	412 361 40	T 40
412 361 15	T 15		

Giraviti Torx lunghi, lama cromata, punta nera

Long Screwdriver Torx

Acciaio Cr. V.



412 368 10	T 10x300	412 368 27	T 27x300
412 368 15	T 15x300	412 368 30	T 30x300
412 368 20	T 20x300	412 368 40	T 40x300
412 368 25	T 25x300		

Giravite Torx forato, lama cromata, punta nera. Impugnatura ergonomica bicomponente

Screwdriver Torx with hol

Acciaio Cr. V.



412 385 11 Serie giraviti Torx forati - Pz 11

Ricambi - Spare parts



412 38106	T 6H	412 38120	T 20H.
412 38107	T 7H	412 38125	T 25H
412 38108	T 8H	412 38127	T 27H
412 38109	T 9H	412 38130	T 30H
412 38110	T 10H	412 38140	T 40H
412 38115	T 15H		

Giravite impronta Penta Torx forato, impugnatura in plastica bicomponente

Screwdriver Penta-Torx with hole

Acciaio Cr. V.



- 412 391 Set giraviti Penta-Torx forati - T10 -T40 - 7 Pz
- 412 392 Set giraviti Penta-Torx forati - T 6 - T40 - 11 Pz

Ricambi - Spare parts



- | | |
|------------------|------------------|
| 412 390 06 T 6H | 412 390 20 T 20H |
| 412 390 07 T 7H | 412 390 25 T 25H |
| 412 390 08 T 8H | 412 390 27 T 27H |
| 412 390 09 T 9H | 412 390 30 T 30H |
| 412 390 10 T 10H | 412 390 40 T 40H |
| 412 390 15 T 15H | |

Set inserti Torx snodati con pratica impugnatura rotativa

Made in Germany



412 400 Pz 6



Composizione - Composition

- Tx20 x 125 colore oro
- Tx22 x 145 colore blu
- Tx27 x 155 colore rosso
- Tx30 x 175 colore verde
- Tx40 x 195 colore giallo
- Tx45 x 220 colore nero

NOTE

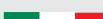

Chiavi Torx a tre teste con asta scorrevole

T-shape Torx key

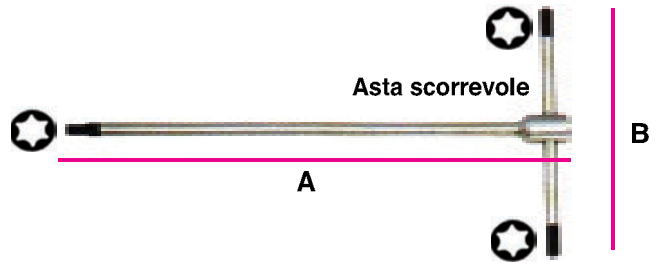

	A	B	Tx
412 401	125	65	6
412 402	125	65	7
412 403	125	65	8
412 404	125	65	9
412 405	125	65	10
412 406	125	65	15
412 407	125	65	20
412 408	180	90	25
412 409	180	90	27
412 410	180	90	30
412 411	210	105	40
412 412	210	105	45
412 413	210	105	50

Chiave a "T" fissa con 3 estremità maschio Torx. Punta brunita

Acciaio Cr. V.
Cromatura satinata



412 418 06	6 mm	412 418 25	25 mm
412 418 07	7 mm	412 418 27	27 mm
412 418 08	8 mm	412 418 30	30 mm
412 418 09	9 mm	412 418 40	40 mm
412 418 10	10 mm	412 418 45	45 mm
412 418 15	15 mm	412 418 50	50 mm
412 418 20	20 mm		

Set chiavi a T a tre teste Torx in custodia a cerniera



412 420 T10, 15, 20, 25,27, 30, 40 - Pz.7

Chiave a T con maschio Torx snodato

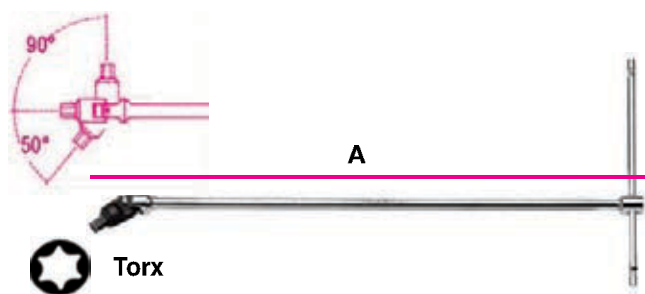

	A	Torx
412 421 20	394	T20
412 421 25	394	T25
412 421 27	394	T27
412 421 30	402	T30
412 421 40	402	T40
412 421 45	425	T45
412 421 50	440	T50
412 421 55	440	T55

Serie chiavi impronta millerighe XZN

Set multi pline keys

Made in Germany



412 430 5, 6, 8, 10, 12, 14 Pz 6

Ricambi - Spare parts

412 422	mm 5	412 425	mm 10
412 423	mm 6	412 426	mm 12
412 424	mm 8	412 427	mm 14

Serie chiavi impronta millerighe XZN

Set multi pline keys



412 440 5, 6, 8, 10, 12, 14 Pz 6
412 440 07 4, 5, 6, 8, 10, 12, 14 Pz 7

Ricambi - Spare parts

412 431	mm 4	412 435	mm 10
412 432	mm 5	412 436	mm 12
412 433	mm 6	412 437	mm 14
412 434	mm 8		

Chiave impronta Ribe

Spline ribe keys

Cr.V. AFA
Nichelate



412 510 Serie 4-5-6-8-10-12-14 mm - 7 pcs

412 501	4 mm	412 505	10 mm
412 502	5 mm	412 506	12 mm
412 503	6 mm	412 507	14 mm
412 504	8 mm		

Set chiavi ribe a L lunghe da M4 a M10

Long Ribe wrench

Acciaio Cr. Mo. -
Cromato



412 520 Pz 7

Composizione - Composition

M 4 x 125 - M 5 x 150 - M 6 x 170 - M 7 x 180 - M 8 x 190 - M 9 x 200 - M 10 x 220

Inserti per viti esascalate Fiat

Bits of Fiat new bits



412 621	6x32 mm	5/16"
412 623	8x32 mm	5/16"
412 625	10x32 mm	5/16"
412 627	6x65 mm	5/16"
412 629	8x65 mm	5/16"
412 631	10x65 mm	5/16"
412 633	6x175 mm	5/16"
412 635	8x175 mm	5/16"
412 637	10x175 mm	5/16"

Confezione viti esascalate Fiat att. 5/16"

Set of Fiat new bits



412 640 6-8-10 x 32 mm
6-8-10 x 65 mm
6-8-10 x 175 mm

Chiave fissa Din 894

Open end wrench Din 894

Acciaio legato
Zincata



413 001	6 mm	413 021	36 mm
413 002	7 mm	413 022	38 mm
413 003	8 mm	413 023	40 mm
413 004	9 mm	413 024	41 mm
413 005	10 mm	413 025	42 mm
413 006	11 mm	413 026	46 mm
413 007	12 mm	413 027	50 mm
413 008	13 mm	413 028	55 mm
413 009	14 mm	413 029	60 mm
413 010	15 mm	413 030	65 mm
413 011	16 mm	413 031	70 mm
413 012	17 mm	413 032	75 mm
413 013	18 mm	413 033	80 mm
413 014	19 mm	413 034	85 mm
413 014 02	21 mm	413 035	90 mm
413 015	22 mm	413 036	95 mm
413 016	24 mm	413 037	100 mm
413 017	27 mm	413 038	105 mm
413 018	28 mm	413 039	110 mm
413 019	30 mm	413 040	115 mm
413 020	32 mm	413 041	120 mm
413 020 02	34 mm		

Chiave fissa doppia bocca Din 895

Double open end wrench Din 895

Acciaio legato
Zincata



413 050	6x7 mm	413 070	19x24 mm
413 051	7x8 mm	413 071	20x22 mm
413 052	8x9 mm	413 072	21x23 mm
413 053	8x10 mm	413 072 01	21x24 mm
413 053 01	9x11 mm	413 073	22x24 mm
413 054	10x11 mm	413 074	24x26 mm
413 055	10x12 mm	413 075	24x27 mm
413 056	10x13 mm	413 076	24x30 mm
413 057	11x13 mm	413 077	25x28 mm
413 058	12x13 mm	413 078	27x30 mm
413 059	12x14 mm	413 079	27x32 mm
413 060	13x14 mm	413 080	30x32 mm
413 061	13x15 mm	413 081	30x36 mm
413 062	13x17 mm	413 082	32x36 mm
413 063	14x15 mm	413 083	35x38 mm
413 064	14x17 mm	413 084	36x41 mm
413 065	16x17 mm	413 085	41x46 mm
413 066	17x19 mm	413 086	46x50 mm
413 067	17x22 mm	413 087	50x55 mm
413 068	18x19 mm	413 088	55x60 mm
413 069	19x22 mm		

Chiave fissa doppia bocca

Double open wrench

Acciaio cr. V.



413 100	mm 5 x 5.5	413 108	mm 20 x 22
413 101	mm 6 x 7	413 109	mm 21 x 23
413 102	mm 8 x 9	413 110	mm 24 x 26
413 103	mm 10 x 11	413 111	mm 24 x 27
413 104	mm 12 x 13	413 112	mm 25 x 28
413 105	mm 14 x 15	413 112 01	mm 27 x 29
413 106	mm 16 x 17	413 113	mm 30 x 32
413 107	mm 18 x 19		

Serie chiavi fisse doppia bocca

Set of double open end wrench

Crom Vanadium
Cromata



413 145	6x7 - 20x22	8 pcs
413 146	6x7 - 30x32	12 pcs

Serie di chiavi fisse "Tipo Economico"

Double open end wrench "Economic type"

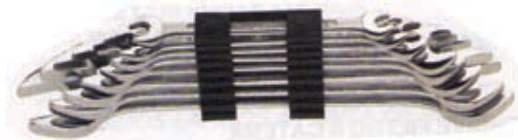

413 149 08	6 - 22	Pz 8
413 149 12	6 - 32	Pz 12

Chiave combinata

Combination wrench

Crom Vanadium
Cromata



413 150	5.5 mm	413 165	20 mm
413 151	6 mm	413 166	21 mm
413 152	7 mm	413 167	22 mm
413 153	8 mm	413 168	23 mm
413 154	9 mm	413 169	24 mm
413 155	10 mm	413 170	25 mm
413 156	11 mm	413 171	26 mm
413 157	12 mm	413 172	27 mm
413 158	13 mm	413 173	28 mm
413 159	14 mm	413 173 29	29 mm
413 160	15 mm	413 174	30 mm
413 161	16 mm	413 175	32 mm
413 162	17 mm	413 175 34	34 mm
413 163	18 mm	413 175 41	41 mm
413 164	19 mm		

Chiavi combinate acciaio tipo pesante

Combination wrench heavy steel Wagner

Acciaio Cr. V.
Cromato - Din 3113



413 176	L. mm 385	mm 33
413 177	L. mm 385	mm 34
413 178	L. mm 410	mm 35
413 179	L. mm 410	mm 36
413 180	L. mm 435	mm 38
413 182	L. mm 460	mm 41
413 183	L. mm 460	mm 42
413 186	L. mm 500	mm 46
413 188	L. mm 540	mm 48
413 189	L. mm 540	mm 50
413 191	L. mm 560	mm 55
413 192	L. mm 600	mm 60
413 193	L. mm 680	mm 65
413 194	L. mm 680	mm 70

Serie di chiavi combinate

Set of combinations wrenches

Crom Vanadium
Cromata



413 195	6-22 mm	17 pcs
413 196	6-32 mm	25 pcs

Serie di chiavi combinate satinare dalla 6 alla 32 in pratica busta con compartimenti singoli

Set of combination wrenches mm 6 - mm 32

Acciaio Cr. V.



413 198	mm 6 - mm 32 - Pz 25
---------	----------------------

Serie di chiavi combinate con supporto in plastica

Set of combination wrench

Acciaio Cr. V.



413 192	mm 6, 7, 8, 9, 10, 11, 12, 13, 14, 17, 17, 22	Pz 12
---------	---	-------

Serie di chiavi combinate in scatola

Set of combination wrench

Acciaio Cr. V.



413 193	mm 6, 7, 8, 9, 10, 11, 12, 13, 14, 17, 17, 22	Pz 12
---------	---	-------

PERSONALIZZABILE

A richiesta possiamo personalizzarle tramite marcatura al Laser. Ideale per le officine che hanno più operatori, per un regalo originale o semplicemente per chi vuole distinguersi



413 198 01	Prezzo per la sola marcatura di 1 serie
413 198 05	Prezzo per la sola marcatura di min. 5 serie
413 198 10	Prezzo per la sola marcatura di min. 10 serie

Serie di chiavi combinate "Tipo Economico"

Combination spanner "Economic type"



413 199 12	6-7-8-9-10-11-12-13-14-17-19-22	Pz 12
413 199 25	6-7-8-9-10-11-12-13-14-15-16-17-18-19 - 20-21-22-23-24-25-26-27-28-30-32	Pz 25

Chiavi combinate Jumbo

Key combined Jumbo

**Acciaio Cr.V.
Cromato**



413 200	Lungh. mm 485	36 mm
413 201	Lungh. mm 540	41 mm
413 201 01	Lungh. mm 540	42 mm
413 202	Lungh. mm 610	46 mm
413 206	Lungh. mm 760	65 mm

Chiave combinata poligonale per motorini di avviamento

Half moon Polygonal wrench

Acciaio Cr. V. - Cromato



413 220	mm 8 x 10	413 223	mm 14 x 17
413 221	mm 10 x 12	413 223 01	mm 16 x 18
413 222	mm 11 x 13	413 223 02	mm 17 x 19
413 222 01	mm 12 x 14	413 224	mm 19 x 22

Serie chiavi poligonali curve

Set of double off serring wrench



413 295	dalla 6x7 alla 20x22	Pz 8
413 296	dalla 6x7 alla 30x32	Pz 12

Ricambi - Spare parts

413 251	6x7 mm	413 258	20x22 mm
413 252	8x9 mm	413 259	21x23 mm
413 253	10x11 mm	413 260	24x26 mm
413 254	12x13 mm	413 261	24x27 mm
413 255	14x15 mm	413 262	25x28 mm
413 256	16x17 mm	413 263	30x32 mm
413 257	18x19 mm		

Chiave poligonale curva per ponteggi

Double off set ring wrench for industry

**Acciaio Cr.V.
Zincato**



413 298	21x22 mm
---------	----------

Chiave combinata lunga

Combination long wrench

**Crom Molibdeno
Cromata Lucida**



413 301	10 mm	413 309	18 mm
413 302	11 mm	413 310	19 mm
413 303	12 mm	413 311	20 mm
413 304	13 mm	413 312	21 mm
413 305	14 mm	413 313	22 mm
413 306	15 mm	413 314	23 mm
413 307	16 mm	413 315	24 mm
413 308	17 mm	413 316	26 mm

Chiavi combinate poligonali a cricchetto reversibile 72 denti

12 Pt. combined key 72 theet reversible

**Acciaio Cr. Mo.
Cromato**



413 320	8 mm	413 326	14 mm
413 321	9 mm	413 327	15 mm
413 322	10 mm	413 328	16 mm
413 323	11 mm	413 329	17 mm
413 324	12 mm	413 330	18 mm
413 325	13 mm	413 331	19 mm

Set chiavi combinate poligonali a cricchetto a denti SPLINE

Set combined wrench reversible - Theet SPLINE

**Acciaio Cr. Mo.
Cromato**



413 335	da 8 a 19 mm 12 pz
---------	--------------------

Chiavi combinate poligonali mini a cricchetto reversibile 72 denti

Combined key 72 theet reversible

Acciaio Cr. Mo. Cromato



413 340	10 mm	413 344	14 mm
413 341	11 mm	413 345	15 mm
413 342	12 mm	413 346	16 mm
413 343	13 mm	413 347	17 mm

Chiave combinata poligonale tipo piatto a cricchetto mini

Key combined to gear stubby mini

Acciaio Cr. Mo. Cromato



413 350	60 Denti	8 mm
413 351	60 Denti	9 mm
413 352	60 Denti	10 mm
413 353	72 Denti	11 mm
413 354	72 Denti	12 mm
413 355	72 Denti	13 mm
413 356	72 Denti	14 mm
413 357	72 Denti	15 mm
413 358	72 Denti	16 mm
413 359	72 Denti	17 mm

Set chiavi combinate a cricchetto 72D mini

Set key combined to gear stubby 72D mini

Acciaio Cr. Mo.

Cromato



413 362	8-10-12-13-14-15-17	7 pz.
---------	---------------------	-------

Chiave combinata a cricchetto a 72 denti testa snodata

Acciaio Cr. Mo. Cromato



413 368	mm 8	413 374	mm 14
413 369	mm 9	413 375	mm 15
413 370	mm 10	413 376	mm 16
413 371	mm 11	413 377	mm 17
413 372	mm 12	413 378	mm 18
413 373	mm 13	413 379	mm 19

Kit chiavi combinate a cricchetto snodato

Acciaio Cr. Mo. Cromato



413 380	8-10-12-13-14-17-19	7 pz.
---------	---------------------	-------

Chiavi combinate piatte a cricchetto con impugnatura ergonomica - 72 denti

Lighter combination wrench reversible - Model Ergo

Acciaio Cr. Mo. Cromato



413 390 08	mm 8	413 390 14	mm 14
413 390 09	mm 9	413 390 15	mm 15
413 390 10	mm 10	413 390 16	mm 16
413 390 11	mm 11	413 390 17	mm 17
413 390 12	mm 12	413 390 18	mm 18
413 390 13	mm 13	413 390 19	mm 19

Chiavi combinate piatte a cricchetto con impugnatura ergonomica - 72 denti

Lighter combination wrench reversible - Model Ergo

Acciaio Cr. Molibdeno Cromato



413 391	In blister mm 10-12-13-14-15	Pz 5
---------	------------------------------	------

Set chiavi combinate con bussola poligonale snodata

12Pc flex head socket/open end wrench set



413 416 Pz 12

Composizione - Composition

413 416 08	mm 8	413 416 14	mm 14
413 416 09	mm 9	413 416 15	mm 15
413 416 10	mm 10	413 416 16	mm 16
413 416 11	mm 11	413 416 17	mm 17
413 416 12	mm 12	413 416 18	mm 18
413 416 13	mm 13	413 416 19	mm 19

Chiave a cricchetto poligonale multi misura

Double ratchet off set wrench four measures



413 421 13-14-15-17 mm

Chiave a cricchetto con 4 quadri di manovra

Ratchet wrench with 4 square

Acciaio Cr.V.
Cromato



413 425 3/16"-1/4"-5/16"-3/8"

Chiave poligonale a "T" con cricchetto snodato

"T" type swivel head ratcheting wrench



413 430 10	mm 10	413 430 13	mm 13
413 430 12	mm 12	413 430 14	mm 14

Set chiavi a cricchetto poligonale piatta reversibile

Set double ratchet off set wrenches reversible



413 439 6x8 - 9x10 - 11x13 - 12x14 - 15x17 - 19x22 6 pcs

Serie di chiavi a cricchetto poligonali curve reversibili, economiche

Set of double ratchet off set ring reversible wrenches



413 440 10x12-12x13-14x15-16x17-18x19-20x22 6 pcs

Chiave a cricchetto reversibile poligonale curva

Double ratchet off set ring reversible wrench

Acciaio Cr. Mo. Cromato



413 441 01	mm 8 x 10	413 441 06	mm 15 X 16
413 441 02	mm 10 X 11	413 441 07	mm 17 X 19
413 441 03	mm 11 X 13	413 441 08	mm 19 X 22
413 441 04	mm 12 X 14	413 441 09	mm 24 X 27
413 441 05	mm 13 X 17	413 441 10	mm 30 X 32

Set chiavi poligonali a cricchetto reversibile 7 Pz.

Polygonal key set to reversing double ratchet off 7 Pzes.

Acciaio Cr. Mo.
Cromato



413 445 10x11-12x14-13x17-15x16-19x22-24x27-30x32

Serie di chiavi a cricchetto poligonali curve reversibili

Set of double ratchet off set ring reversible wrenches

**Acciaio Cr. Mo.
Cromato**



413 446 10x12-11x13-14x17 3 pcs

Tubi per chiavi poligonali piegate



413 447 01 Solo tubo 350 mm
413 447 02 Solo tubo 580 mm
413 447 03 Solo tubo 850 mm

Chiavi poligonali curve piegate



413 447 27 27 mm	413 447 46 46 mm
413 447 30 30 mm	417 447 50 50 mm
413 447 32 32 mm	413 447 55 55 mm
413 447 41 41 mm	413 447 60 60 mm

Serie chiavi combinate a frizione

Set of ratchet combination wrench



413 460 dalla 10 alla 19 Pz 6

Chiavi sciolte - Singular wrench

413 448 8 mm	413 454 14 mm
413 449 9 mm	413 455 15 mm
413 450 10 mm	413 456 16 mm
413 451 11 mm	413 457 17 mm
413 452 12 mm	413 458 18 mm
413 453 13 mm	413 459 19 mm

Chiave fissa aperta esagonale dadi di raccordo tubazioni

Flare nut wrench for pipe fittings

**Crom Vanadium
Cromata**



413 461 8x10 mm	413 466 13x14 mm
413 462 10x11 mm	413 467 14x17 mm
413 463 10x12 mm	413 468 16x18 mm
413 464 11x13 mm	413 469 17x19 mm
413 465 12x14 mm	

Chiave doppia aperta con una bocca esagonale fissa e una bocca poligonale snodata particolarmente adatta per raccordi tubetti freno

Double open wrench exagonal & joint polygonal

Acciaio Cr. Molibdeno - Cromato



413 471 Set 6 Pz	mm 8-10-11-12-13-14
413 472 Set 8 Pz	mm 8- 9-10-11-12-13-14-17
413 473 Set 10 Pz.	mm 8-9-10-11-12-13-14-15-17-19

Ricambi - Spare parts

413 470 08 mm 8	413 470 13 mm 13
413 470 09 mm 9	413 470 14 mm 14
413 470 10 mm 10	413 470 15 mm 15
413 470 11 mm 11	413 470 17 mm 17
413 470 12 mm 12	413 470 19 mm 19

Chiavi snodate combinate con testa a molla apri e chiudi brevettata

Brake pipe wrench



413 475 Set 4 chiavi in busta

Composizione - Composition

413 475 01	Chiave singola mm 8 x 9
413 475 02	Chiave singola mm 10 x 11
413 475 03	Chiave singola mm 12 x 13
413 475 04	Chiave singola mm 14 x 15

Serie chiavi fisse aperte esagonale dadi di raccordo tubazioni

Set of flare nut wrenches for pipe fittings

**Crom Vanadium
Cromata**



413 481 10x12-13x14-15x17 3 pcs

Chiavi poligonali aperte con quadro 3/8"

Open polygonal wrench 3/8"

**Acciaio Cr. Molibdeno
Cromato**



413 482 Da mm 10 a mm 19 Pz 10

Ricambi - Spare parts



413 482 10	mm 10	413 482 15	mm 15
413 482 11	mm 11	413 482 16	mm 16
413 482 12	mm 12	413 482 17	mm 17
413 482 13	mm 13	413 482 18	mm 18
413 482 14	mm 14	413 482 19	mm 19

Chiavi poligonali aperte con quadro 3/8"

Open polygonal wrench 3/8"

**Acciaio Cr. Molibdeno
Cromato**



413 483 Da 3/8" a 3/4" Pz 7

Ricambi - Spare parts



413 482 21	3/8"	413 482 25	5/8"
413 482 22	7/16"	413 482 26	11/16"
413 482 23	1/2"	413 482 27	3/4"
413 482 24	9/16"		

Chiavi esagonali aperte con quadro 3/8"

Open hexagonal wrench 3/8"

**Acciaio Cr. Molibdeno
Brunita**



413 495 Da mm 10 a mm 19 Pz 10

Ricambi - Spare parts



413 495 10	mm 10	413 495 15	mm 15
413 495 11	mm 11	413 495 16	mm 16
413 495 12	mm 12	413 495 17	mm 17
413 495 13	mm 13	413 495 18	mm 18
413 495 14	mm 14	413 495 19	mm 19

Chiave aperta con quadro 1/2"

Key open with square 1/2"

**Acciaio Cr.V.
Cromato**



413 496 27	27 mm	413 496 36	36 mm
413 496 29	29 mm	413 496 38	38 mm
413 496 30	30 mm	413 496 41	41 mm
413 496 32	32 mm	413 496 43	43 mm
413 496 33	33 mm	413 496 46	46 mm
413 496 34	34 mm	413 496 48	48 mm
413 496 35	35 mm	413 496 50	50 mm

Set 14 pz chiavi aperte con quadro 1/2"

Set 14 key pzes open with square 1/2"



413 497 da 27 a 50 mm

Chiave aperta pesante con quadro 1/2"

Key open with square 1/2"

Acciaio Cr.V.
Cromato



Att. 1 / 2"



413 498 20	mm 20	413 498 26	mm 26
413 498 21	mm 21	413 498 27	mm 27
413 498 22	mm 22	413 498 28	mm 28
413 498 23	mm 23	413 498 29	mm 29
413 498 24	mm 24	413 498 30	mm 30
413 498 25	mm 25	413 498 32	mm 32

Set 11 pz chiavi aperte pesanti con quadro di manovra 1/2"

Set 10 key pzes open with square 1/2



413 499 da 20 a 32 mm

Chiave Torx E piatta

Torx E wrench flat

Crom Vanadium
Cromata



413 501	E6xE8 mm	413 504	E14XE18 mm
413 502	E7XE11 mm	413 505	E16XE22 mm
413 503	E10XE12 mm	413 506	E20XE24 mm

Serie di chiavi Torx E piatta

Set of torx E wrenches flat

Crom Vanadium
Cromata



413 511 E6xE8-E10XE12-E14XE18-E20XE24 4 pcs

Chiave torx femmina piatta a cricchetto

Key torx flat female to ratchet

Acciaio Cr.V.
Cromato



413 515	E6xE8	413 517	E14xE18
413 516	E10xE12	413 518	E20xE24

Set 4 Pz chiavi Torx extra lunghe a cricchetto 72 denti con doppio snodo

4Pcs extra long double star box flexible ratchet wrench set

Acciaio Cr. V.



413 519 E6 X E8, E10 X E12, E14 X E18, E20 X E24 Pz 4

Set 14 pz chiavi aperte con quadro 1/2"

Set 14 key pzes open with square 1/2"

Acc. INOX inserto Cr.Mo.
Lucidate



413 520 E6xE8 - E10xE12 - E14xE16 - E20xE24

Chiave Torx femmina piegata

Acc. Cr.V.
Cromato



413 521	E 6X8	413 524	E 14X18
413 522	E 7X11	413 525	E 16X22
413 523	E10X12	413 526	E 20X24

Set 6 Pz. chiavi torx femmina curve

Set 6 PZ key torx female

Acc. Cr.V.
Cromato



413 530 6x8 - 7x11 - 10x12 - 14x18 - 16x22 - 20x24

Serie di chiavi multiple

Set of multipurpose wrenches



413 540 8x10-9x11-12x14-13x15-17x19-21x23 mm 3 pcs

Chiave fissa a percussione

Percussion open end wrench

Acciaio legato
Zincata



413 551	24 mm	413 560	60 mm
413 552	27 mm	413 561	65 mm
413 553	30 mm	413 562	70 mm
413 554	32 mm	413 563	75 mm
413 555	36 mm	413 564	80 mm
413 556	41 mm	413 565	85 mm
413 557	46 mm	413 566	90 mm
413 558	50 mm	413 567	95 mm
413 559	55 mm	413 568	100 mm

NOTE



Chiave poligonale a percussione

Percussion off set ring wrench

Acciaio legato
Zincata



413 575	24 mm	413 584	60 mm
413 576	27 mm	413 585	65 mm
413 577	30 mm	413 587	75 mm
413 578	32 mm	413 586	70 mm
413 579	36 mm	413 588	80 mm
413 580	41 mm	413 589	85 mm
413 581	46 mm	413 590	90 mm
413 582	50 mm	413 591	95 mm
413 583	55 mm	413 592	100 mm

Chiavi regolabili

Adjustable wrench

Acciaio forgiato
Cromata



413 601	6"
413 602	8"

Set 3 Pz. chiavi in acciaio inox lucidato a specchio con azione a cricchetto a 30° per facilità d'uso in spazi limitati

Made in U.S.A.



MASSIMA TORSIONE RACCOMANDABILE



mm	10	12	13	14	15	17
Nm	24	42	52	64	77	107

413 609	Set	10x12 - 13x14 - 15x17mm
413 609 10	Chiave aperta 30° -	mm 10x12
413 609 13	Chiave aperta 30° -	mm 13x14
413 609 15	Chiave aperta 30° -	mm 15x17

Set 3 Pz. chiavi in acciaio inox lucidato a specchio con azione a cricchetto a 30° per facilità d'uso in spazi limitati

Set 3 Pzes. keys in steel inox polished with action to ratchet wrench to 30° for facility to use in limited spaces

Made in U.S.A.



MASSIMA TORSIONE RACCOMANDABILE



in	3/8	7/16	1/2	9/16	5/8	11/16
ft.lb	18	31	39	48	57	80

413 610 Set 3/8x7/16" - 1/2x9/16" - 5/8x11/16"

Chiave poligonale aperta a cricchetto



413 615 10	mm 10	413 615 17	mm 17
413 615 11	mm 11	413 615 19	mm 19
413 615 13	mm 13	413 615 30	mm 30

Prolunga universale

Universal prolong

Quadro di manovra 1/2"



mm 340



413 618 Made in Germany
413 619 Import

Chiave a rullino

Adjustable wrench



413 621	mm 150	413 625	mm 380
413 622	mm 200	413 626	mm 450
413 623	mm 250	413 627	mm 600
413 624	mm 300		

Cricchetto con bussola variabile

Ratchet with variable socket



413 631	8-14 mm	5/16-17/32"
413 632	11-19 mm	7/16-3/4"

Chiave serraggio ghiera autoblock con quadro da 1/2"-3/4"

Auto block ferrules socket with square 1/2"

Acc. Bonificato
Brunito



Cod.	Ø ghiera	Ø filetto	n. denti
413 653	25	15x1	4
413 654	28	17x1	4
413 655	32	20x1	4
413 656	38	25x1.5	4
413 657	44	30x1.5	4
413 658	50	35x1.5	4
413 659	56	40x1.5	4
413 660	62	45x1.5	4
413 661	68	50x1.5	4
413 662	75	55x2	6
413 663	80	60x2	6
413 664	85	65x2	6
413 665	92	70x2	6



Chiave serraggio ghiera "KM" con quadro da 1/2"-3/4"

KM ferrules socket with square 1/2"

Acc. Bonificato
Brunito



Cod.	Ø ghiera est.	Ø filetto	n. denti
413 673	25	15x1	4
413 674	28	17x1	4
413 675	32	20x1	4
413 676	38	25x1.5	4
413 677	45	30x1.5	4
413 678	52	35x1.5	4
413 679	58	40x1.5	4
413 680	65	45x1.5	4
413 681	70	50x1.5	4
413 682	75	55x2	4
413 683	80	60x2	4
413 684	85	65x2	4
413 685	92	70x2	4

Chiave serraggio ghiera autobloccanti con dente interno e quadro di manovra 3/4"

Auto block ferrules socket with inside tooth

Acciaio Cr.
Mo. Cromato

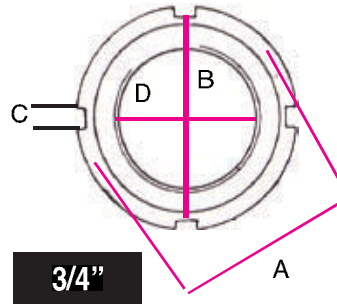

	A	B	C	D	n°denti
413 690 06				30 x 1,5	4
413 690 07	50	44	4	35 x 1,5	4
413 690 08	56	50	6	40 x 1,5	4
413 690 09	62	55	6	45 x 1,5	4
413 690 10	68	61	6	50 x 1,5	4
413 690 11	75	68	7	55 x 2	6
413 690 12	80	73	7	60 x 2	6
413 690 13	85	77	7	65 x 2	6
413 690 14	92	84	8	70 x 2	6
413 690 15	98	89	8	75 x 2	6
413 693 07	60	44	4	35 x 1,5	4
413 693 10	84	62	6	50 x 1,5	4

413 693 07 *Bussola lunga

413 693 10 *Bussola lunga

Chiave serraggio ghiera "KM" con dente interno e quadro di manovra 3/4"

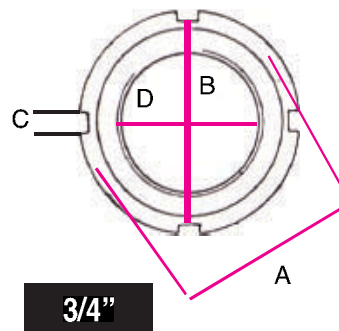

	A	B	C	D	n°denti
413 692 08	58	52	4	40 x 1,5	4
413 692 09	65,8	60,3	6	45 x 1,5	4
413 692 10	70,5	65	6	50 x 1,5	4
413 692 11	76,3	69,3	7	55 x 2	4
413 692 12	80,5	74,5	6,5	60 x 2	4
413 692 13	85,5	79,3	6,5	65 x 2	4
413 692 14	92,5	85,5	7,5	70 x 2	4
413 692 15	98	91,4	7	75 x 2	4

Chiave di serraggio 4 denti per ghiera KM

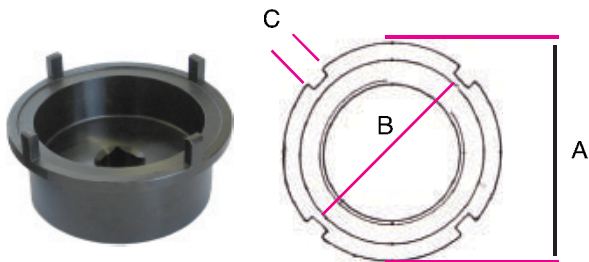

	A	B	C	Att.	Altezza
413 688	114	104	7	3/4"	mm 60

NOTE



**Chiavi a compasso per ghiere con foro.
Perni temprati e rettificati**

Wrench

Acc. Stampato



- 413 695 Apertura mm 20÷100 - 1/2" - Perni Ø 5,5
- 413 696 Apertura mm 40÷150 - 3/4" - Perni Ø 7

Chiave a settore con nasello quadro DIN 1810 A

Hook wrench

Crom Vanadium
Cromata



- | | | | |
|---------|----------|------------|--------------|
| 413 701 | 12-14 mm | 413 711 01 | 92-95 mm |
| 413 702 | 16-20 mm | 413 712 | 98-100 mm |
| 413 703 | 25-28 mm | 413 713 | 110-115 mm |
| 413 704 | 30-32 mm | 413 714 | 120-130 mm |
| 413 705 | 34-36 mm | 413 715 | 135-145 mm |
| 413 706 | 40-42 mm | 413 716 | 155-165 mm |
| 413 707 | 45-50 mm | 413 717 | mm 180 - 195 |
| 413 708 | 52-55 mm | 413 718 | mm 205 - 220 |
| 413 709 | 58-62 mm | 413 719 | mm 230 - 245 |
| 413 710 | 68-75 mm | 413 720 | mm 260 - 270 |
| 413 711 | 80-90 mm | | |

Chiave a settore con nasello tondo DIN 1810 B

Hook wrench

Crom Vanadium
Cromata



- | | | | |
|---------|----------|---------|------------|
| 413 721 | 12-14 mm | 413 729 | 58-62 mm |
| 413 722 | 16-20 mm | 413 730 | 68-75 mm |
| 413 723 | 25-28 mm | 413 731 | 80-90 mm |
| 413 724 | 30-32 mm | 413 732 | 95-100 mm |
| 413 725 | 34-36 mm | 413 733 | 110-115 mm |
| 413 726 | 40-42 mm | 413 734 | 120-130 mm |
| 413 727 | 45-50 mm | 413 735 | 135-145 mm |
| 413 728 | 52-55 mm | 413 736 | 155-165 mm |
| | | 413 737 | 180-195 mm |

**Set chiavi a settore snodate con naselli
intercambiabili quadro e tondo**

8 pcs adjustable hook wrench set



CR-MO
Acciaio cromato

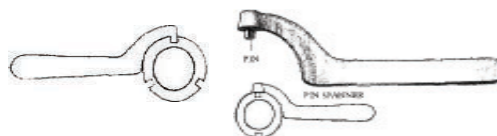

413 780 In valigetta - Pz.8

Dati tecnici - Informative

Pin. Ø4, Ø5, Ø6, Ø7.9

Ideale per collari, anelli di regolazione dado bloccaggio cuscinetti.

Chiave a compasso

Compass Key

Acciaio speciale

Made in Germany



Cod.	Apertura	Lunghezza	ØPerno
413 801	7, 40	115	1.5
413 802	7, 40	115	2
413 803	7, 40	115	2.5
413 804	11, 60	160	3
413 805	11, 60	160	4
413 806	11, 60	160	5
413 807	14, 100	215	5
413 808	14, 100	215	6
413 809	14, 100	215	8

NOTE

