

2023

TOTAL

SELEZIONATO E DISTRIBUITO DA

INECO



TOTAL - Catalogo generale 2023

Tutti i prezzi indicati nel presente catalogo sono da intendersi di listino iva esclusa. Le fotografie, i disegni, le tabelle, i prezzi e tutte le note tecniche del presente catalogo sono puramente indicativi. La società non è a queste in nessun modo vincolata e si riserva il diritto di modifica secondo il proprio insindacabile giudizio e senza preavviso. La riproduzione anche parziale di ogni parte e/o contenuto del presente catalogo è espressamente vietata.



TOTAL

LA SCELTA DI INECO PER GLI UTENSILI DI QUALITÀ

La costante crescita del brand Total riscontrata dal giorno del lancio sino ad oggi, ha portato Ineco a pubblicare la terza edizione del catalogo dedicato al brand. Questa edizione 2023 presenta un ulteriore ed innovativo aumento di gamma, incrementando l'offerta in nuove categorie di prodotti quali il giardinaggio e i portautensili, ed aggiornando le categorie esistenti con prodotti tecnologicamente e qualitativamente ancora più avanzati. Nuovi elettroutensili ed utensili manuali sono stati inseriti per poter soddisfare al meglio i nostri clienti che si trovano ad operare in un mercato sempre più competitivo ed in continua evoluzione.

In Ineco l'innovazione viene sempre accompagnata da accurati controlli di qualità testando in prima persona le nuove tecnologie che vengono lanciate sul mercato. L'affidabilità dei prodotti Total ha permesso di soddisfare anche i professionisti più esigenti che hanno trovato in Total il partner ideale per lo svolgimento di lavori in molteplici

ambiti professionali. Un ulteriore valore aggiunto viene conferito ai prodotti Total dal packaging chiaro e moderno che, riportando tutte le informazioni di prodotto, facilita il cliente nella scelta dell'utensile adatto alle sue esigenze.

A supporto della clientela Ineco mette a disposizione una rete commerciale distribuita su tutto il territorio nazionale, oltre che una pronta assistenza da parte degli uffici commerciali locati nella sede centrale di Osnago, che vanta un magazzino recentemente ampliato a 7500 mq ed una showroom dedicata all'esposizione dei prodotti.

L'attenzione al cliente è il punto cardine della storia di Ineco e lo sarà anche per il futuro, con l'obiettivo di mantenere inalterato l'elevato grado di servizio che da sempre ne contraddistingue l'operato.

INECO
WE ARE PRECISION

EKRINO
GROUP



470

**ELETTROUTENSILI
A BATTERIA**

Pag. 6-25



472

**ELETTROUTENSILI
A FILO**

Pag. 26-37



474

**ACCESSORI PER
ELETTROUTENSILI**

Pag. 38-61



416

**PINZE
E TRONCHESI**

Pag. 62-77



418

GIRAVITI

Pag. 78-91



420

**CHIAVI
MASCHIO**

Pag. 92-98



422

**CHIAVI DI
MANOVRA**

Pag. 100-107



424

**CHIAVI
A BUSSOLA**

Pag. 108-115



426

**MARTELLI
E SCALPELLI**

Pag. 116-121



428

**UTENSILI
DA TAGLIO**

Pag. 122-127



437

SERRAGGIO

Pag. 128-129



448

**MANUTENZIONI
VARIE**

Pag. 130-136

**430****SEGHE
E SEGHETTI**Pag. **138-143****432****LIME
E RASPE**Pag. **144-145****440****STRUMENTI
DI MISURA**Pag. **146-147****434****UTENSILI PER
ELETTRICISTA**Pag. **148-157****436****UTENSILI PER
IDRAULICO**Pag. **158-161****447/448****PORTA
UTENSILI**Pag. **162-169****424****SET DI UTENSILI
E CARRELLI**Pag. **170-179****480/482****GIARDINAGGIO**Pag. **180-193****454****MERCHANDISING**Pag. **194****ALLESTIMENTI
ED ESPOSITORI**Pag. **196-197****CONDIZIONI ORDINI - P. 198****GARANZIA - P. 199**

ELETTROUTENSILI A BATTERIA

470



20V MAX SHARE



P20S SAME BATTERY 150+ TOOLS

ELETTROUTENSILI A BATTERIA

INDUSTRIAL TOTAL
47016
**TRAPANO AVVITATORE 20 V CON PERCUSSIONE,
MOTORE BRUSHLESS, 2 BATTERIE**

Motore Brushless
Tensione della batteria: 20V

Velocità max: 0-450/0-1900 rpm

Massimo numero di colpi: 22500/min

Coppia di serraggio: 60NM

Capacità di serraggio mandrino: 0-13 mm

Posizioni della coppia di serraggio: 23+1+1

Mandrino autoserrante
2 Velocità meccaniche
Batterie: 20 V 2 Ah

2 Batterie incluse

Caricatore 1 ora incluso

Tensione caricatore: 220V-240V~50/60Hz

Luce LED: integrata

Indicatore LED del livello di carica



Specifiche tecniche

INDUSTRIAL

Codice INECO	Codice Total	Prezzo
4701600202	TIDL120608	282.00 €

47008
**TRAPANO AVVITATORE 20 V CON PERCUSSIONE,
2 BATTERIE, 50 ACCESSORI INCLUSI**

Tensione della batteria: 20V

Velocità max: 0-400/0-1500/min

Massimo numero di colpi: 22500/min

Coppia di serraggio: 45NM

Capacità di serraggio mandrino: 0.8-10mm

Posizioni della coppia di serraggio: 18+1+1

Mandrino autoserrante in metallo
2 Velocità meccaniche
Funzione blocco mandrino
Batterie: 20 V 2 Ah

2 Batterie incluse

Caricatore 1 ora incluso

Tensione caricatore: 110V-240V~50/60Hz

Luce LED: integrata

Indicatore LED del livello di carica

50 Accessori inclusi

Specifiche tecniche

INDUSTRIAL

Codice INECO	Codice Total	Prezzo
4700800202	TIDL12002	224.00 €



ELETTROUTENSILI A BATTERIA

INDUSTRIAL TOTAL

47009
**TRAPANO AVVITATORE 20V CON PERCUSSIONE,
2 BATTERIE, SUPER SELECT**

Tensione della batteria: 20V
Velocità max: 0-400/0-1500 rpm
Numero di colpi: 22500/min
Coppia di serraggio: 45NM
Capacità di serraggio mandrino: 0.8-10mm
Posizioni della coppia di serraggio: 18+1+1
2 velocità meccaniche
Batterie: 20 V 2 Ah
 2 Batterie incluse
 Caricatore 1 ora incluso
Tensione caricatore: 220V-240V~50/60Hz
Luce LED: integrata
 Indicatore LED del livello di carica
 Include:
1 inserto 65mm al Cr-V
3 punte per muro



Specifiche tecniche



Codice INECO	Codice Total	Prezzo
4700900202	TDLI200215	185.00 €

47003
**TRAPANO AVVITATORE 20V, 2 BATTERIE,
IN VALIGETTA, SUPER SELECT**

Tensione della batteria: 20V
Velocità max: 0-400/0-1500/min
Coppia di serraggio: 45NM
Capacità di serraggio mandrino: 0,8 - 10 mm
Posizioni della coppia di serraggio: 15+1
2 velocità meccaniche
Batterie: 20 V 2 Ah
 2 Batterie incluse
 Caricatore 1 ora incluso
Tensione caricatore: 220V-240V~50/60Hz
Luce LED: integrata
 Indicatore LED del livello di carica
In valigetta



Specifiche tecniche



Codice INECO	Codice Total	Prezzo
4700300202	TDLI200215	162.00 €



ELETTROUTENSILI A BATTERIA

INDUSTRIAL
TOTAL
47001
**TRAPANO AVVITATORE 12 V,
2 BATTERIE**

Tensione della batteria: 12V
Velocità max: 0-400/0-1500 rpm
Coppia di serraggio: 20NM
Capacità di serraggio mandrino: 0.8-10mm
Posizioni della coppia di serraggio: 15+1
2 Velocità meccaniche
Batterie: 12 V 1.5 Ah
 2 Batterie incluse
 Caricatore 2 ore incluso
Tensione caricatore: 220V-240V~50/60Hz
Luce LED: integrata
1 inserto 65mm al Cr-V incluso



Specifiche tecniche

INDUSTRIAL

Codice INECO	Codice Total	Prezzo
4700100122	TDLI1232E	109.50 €

47000
**SVITA AVVITA 4 V,
SUPER SELECT**

Tensione della batteria: 4V
Attacco: 1/4
Velocità max: 180 rpm
Coppia max: 4 Nm
Luce LED: integrata
Indicatore di carica
 Inclusi:
10 inserti 25 mm al Cr-V
1 portainseri magnetico



Specifiche tecniche

INDUSTRIAL

Codice INECO	Codice Total	Prezzo
4700000004	TSDLI0402	25.50 €

ELETTROUTENSILI A BATTERIA



47018

**AVVITATORE A MASSA BATTENTE 20 V,
MOTORE BRUSHLESS, ATTACCO 1/4**

Nome / Famiglia



Motore Brushless

Tensione della batteria: 20V

Attacco: 1/4

Velocità max: 0-1300/0-2100/min

Numero di colpi: 0-2000/0-3300bpm

Coppia di serraggio: 170NM

Batterie: 20 V 2 Ah

2 Batterie incluse

Caricatore 1 ora incluso

Tensione caricatore: 110V-240V~50/60Hz

Luce LED: integrata

Indicatore LED del livello di carica

2 Inserti inclusi

3 chiavi a bussola incluse



Specifiche tecniche



Codice INECO	Codice Total	Prezzo
4701800202	TIRLI2002	254.00 €



ELETTROUTENSILI A BATTERIA



47020

AVVITATORE A MASSA BATTENTE 20 V, MOTORE BRUSHLESS, ATTACCO 1/2

Nome / Famiglia



- Motore Brushless**
- Tensione della batteria:** 20V
- Attacco:** 1/2
- Velocità max:** 0-1300/0-2100/min
- Numero di colpi:** 0-2000/0-3300bpm
- Coppia di serraggio:** 300NM 20V
- Batterie:** 20 V 2 Ah
- 2 Batterie incluse
- Caricatore 1 ora incluso
- Tensione caricatore:** 110V-240V~50/60Hz
- Luce LED:** integrata
- Indicatore LED del livello di carica
- 3 Bussole incluse (17,19,21 mm)**



Specifiche tecniche



Codice INECO	Codice Total	Prezzo
4702000202	TIWLI2001	260.00 €



ELETTROUTENSILI A BATTERIA

INDUSTRIAL TOTAL

47060

SET AVVITATORE E AVVITATORE A
MASSA BATTENTE ATTACCO 1/4, 20 V

Composto da utensili Total:

TDLI20024

TIRLI2002

Inclusi:

2 batterie 20 V 2.0 Ah

1 caricabatterie 1 ora

2 inserti

3 inserti a bussola



Specifiche tecniche

INDUSTRIAL

Codice INECO	Codice Total	Prezzo
470600001	TCKLI2006	284.00 €



ELETTROUTENSILI A BATTERIA

INDUSTRIAL TOTAL
47061

Nome / Famiglia

**SET AVVITATORE E AVVITATORE A
MASSA BATTENTE ATTACCO 1/2, 20 V**

Composto da utensili Total:

TDLI20024

TIWLI2001

Inclusi:

2 batterie 20 V 2.0 Ah

1 caricabatterie 1 ora

3 bussole (17,19,21 mm)



Specifiche tecniche

INDUSTRIAL

Codice INECO	Codice Total	Prezzo
4706100001	TCKLI2007	284.00 €



ELETTROUTENSILI A BATTERIA

INDUSTRIAL TOTAL

47062

SET AVVITATORE E MARTELLO TASSELLATORE, 20V

Nome / Famiglia



Composto da utensili Total:
TDLI20024
TRHLI1601

Inclusi:

2 batterie 20 V 2.0 Ah
1 caricabatterie 1 ora
3 bussole (17,19,21 mm)



Specifiche tecniche

INDUSTRIAL

Codice INECO	Codice Total	Prezzo
4706200001	TCKLI2008	297.00 €

47063

SET AVVITATORE E SMERIGLIATRICE ANGOLARE, 20V

Nome / Famiglia



Composto da utensili Total:
TDLI20024
TAGLI1151

Inclusi:

2 batterie 20 V 4.0 Ah
1 caricabatterie 2 ore



Specifiche tecniche

INDUSTRIAL

Codice INECO	Codice Total	Prezzo
4706300001	TCKLI2009	356.00 €



ELETTROUTENSILI A BATTERIA

INDUSTRIAL TOTAL
47032
**SMERIGLIATRICE ANGOLARE 20 V,
CORPO MACCHINA**

Nome / Famiglia



Tensione della batteria: 20 V
Velocità max: 8500/min
Diametro del disco: 115mm
Filettatura dell'alberino: M14
1 Disco abrasivo: incluso
Batteria e caricatore: non inclusi



Specifiche tecniche

Codice INECO	Codice Total	Prezzo
4703211520	TAGLI1151	103.00 €

ELETTROUTENSILI A BATTERIA



Nome / Famiglia

47025

MARTELLINO TASSELLATORE 20V, 4 FUNZIONI, MOTORE BRUSHLESS, 2 BATTERIE



Motore Brushless

Tensione della batteria: 20V

Velocità max: 0-1350 rpm

Potenza del colpo max: 1.5 J

Diametro massimo del foro: $\Phi 22$ nel calcestruzzo

Con 4 funzioni: tassellatura, foratura, scappellatura con e senza fissaggio dello scappello

Luce LED: integrata

Tipologia attacco: SDS-PLUS

3 punte SDS-PLUS e 1 scappello inclusi

Batterie: 20 V 4.0 Ah

2 batterie incluse

Caricatore incluso

Tensione caricatore: 220V-240V~50/60Hz

Borsa in tela inclusa



Specifiche tecniche



Codice INECO	Codice Total	Prezzo
4702500202	TRHLI22012	364.00 €

ELETTROUTENSILI A BATTERIA

INDUSTRIAL TOTAL
47024
**MARTELLLO TASSELLATORE 20 V, 4 FUNZIONI,
MOTORE BRUSHLESS, CORPO MACCHINA**

Motore Brushless
Tensione della batteria: 20V
Velocità max: 0-1350/min
Numero di colpi: 0-4700/bpm
Potenza del colpo massima: 1.5J
Diametro massimo del foro: Ø22 nel calcestruzzo
Con 4 funzioni: tassellatura, foratura, scalpellatura
con e senza fissaggio dello scalpello

Luce LED: integrata

Tipologia attacco: SDS-PLUS

3 Punta SDS-PLUS e 1 scalpello: inclusi

Batteria e caricatore: non inclusi

Specifiche tecniche

INDUSTRIAL

Codice INECO	Codice Total	Prezzo
4702400020	TRHLI2201	199.50 €

47022
**MARTELLLO TASSELLATORE 20 V, 3 FUNZIONI,
SDS-PLUS CORPO MACCHINA**

Tensione della batteria: 20V
Velocità max: 0-900/min
Numero di colpi: 0-5100/bpm
Potenza del colpo max: 1.5J
Diametro massimo del foro: Ø16 nel calcestruzzo
Con 3 funzioni: tassellatura, foratura,
scalpellatura con fissaggio dello scalpello

Luce LED: integrata

3 Punta SDS-PLUS: incluse

Batteria e caricatore: non inclusi

Specifiche tecniche

Codice INECO	Codice Total	Prezzo
4702200001	TRHLI1601	118.50 €



ELETTROUTENSILI A BATTERIA



Nome / Famiglia

47026

SEGA CIRCOLARE 20V, CORPO MACCHINA



Tensione: 20V
Velocità massima: 4600 rpm
Diametro della lama: 165 mm
Capacità di taglio:
 45°: 38 mm
 90°: 55 mm
 Profondità di taglio regolabile
 Inclinazione di taglio regolabile
 1 lama 165 mm inclusa



Specifiche tecniche



Codice INECO	Codice Total	Prezzo
4702600020	TSLI1651	144.00 €

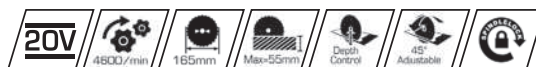

Nome / Famiglia

47028

SEGHETTO ALTERNATIVO 20 V, CORPO MACCHINA



Tensione della batteria: 20 V
Velocità max: 2400rpm
Capacità di taglio:
 Metallo: 8mm
 Legno: 8mm
5 Lame: incluso
Batteria e caricatore: non inclusi
 Righello di guida



5Pcs Jig Saw Blades Free



Specifiche tecniche



Codice INECO	Codice Total	Prezzo
4702800001	TJSLI8501	106.50 €

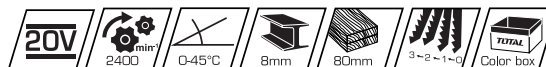

ELETTROUTENSILI A BATTERIA

INDUSTRIAL TOTAL
47030
**SEGA A GATTUCCIO 20 V,
CORPO MACCHINA**

Nome / Famiglia

Tensione della batteria: 20V
Velocità max: 0-2800/min
Capacità di taglio:

Metallo: 8mm

Legno: 115mm

2 Lame Sabre: incluse
Batteria e caricatore: non inclusi

Specifiche tecniche



Codice INECO	Codice Total	Prezzo
4703000001	TRSLI1151	140.50 €

47034
**UTENSILE MULTIFUNZIONE 20 V,
CORPO MACCHINA**

Nome / Famiglia

Tensione della batteria: 20V
Velocità max: 5000-20000r/min
1 Raschietto: incluso
1 Lama da taglio: incluso
1 Lama segmentata: inclusa
1 Chiave esagonale: inclusa
1 Platello: incluso
3 Fogli abrasivi inclusi
Batteria e caricatore: non inclusi

Specifiche tecniche

Codice INECO	Codice Total	Prezzo
4703400001	TMLI2001	66.50 €



ELETTROUTENSILI A BATTERIA

INDUSTRIAL TOTAL

47036

LEVIGATRICE ROTORBITALE 20 V,
CORPO MACCHINA

Tensione della batteria: 20 V
Velocità max: 10000/min
Dimensioni piastra: 125mm
5 Fogli abrasivi: incluso
Batteria e caricatore: non inclusi



x5pcs



Specifiche tecniche

Codice INECO	Codice Total	Prezzo
4703600001	TROSLI2001	88.50 €

47046

PISTOLA PER COLLA A CALDO 20 V,
CORPO MACCHINA

Descrizione

Pistola per colla a caldo 20V, funziona con stick di colla diametro 11,2 mm, 3 stick inclusi



Tensione della batteria: 20V
Portata: 13-18g/min
Diametro colla: 11.2mm
Tempo di riscaldamento: 60 sec
3 Stick colla 11.2 mm: inclusi
Batteria e caricatore: non inclusi



Specifiche tecniche

Codice INECO	Codice Total	Prezzo
4704600001	TGGLI2001	30.20 €



ELETTROUTENSILI A BATTERIA

INDUSTRIAL TOTAL
47038

MINI COMPRESSORE PORTATILE 20 V, CORPO MACCHINA

Nome / Famiglia

Descrizione

Compressore portatile max 10 Bar, ideale per gonfiare ad elevata pressione gomme auto, palloni, ecc.



Tensione della batteria: 20V
Massima pressione: 150PSI/10BAR
1 Adattatore per palloni: incluso
1 Adattatore per pneumatici: incluso
Batteria e caricatore: non inclusi



Specifiche tecniche

Codice INECO	Codice Total	Prezzo
4703800001	TACL12001	57.00 €

47040

COMPRESSORE PORTATILE MAX 11 BAR, ALIMENTAZIONE A BATTERIA 20 V O A FILO CON SPINA 12 V CORPO MACCHINA

Nome / Famiglia

Descrizione

Compressore portatile senza serbatoio con doppia funzione per gonfiare ad elevata pressione (es. gomme auto) o ad elevato volume (es. materassini), funzione di autospegnimento al raggiungimento della pressione impostata, completo di accessori.



Tensione della batteria: 20V
Massima pressione: 160PSI/11BAR
Display digitale
Stop automatico a pressione impostata
Alimentazione 12V o a batteria
Cavo 12V 3 m incluso
1 Adattatore per palloni: incluso
1 Adattatore per pneumatici: incluso
1 Adattatore per materassi: incluso
Batteria e caricatore: non inclusi



Specifiche tecniche

Codice INECO	Codice Total	Prezzo
4704000001	TACL12002	133.00 €



ELETTROUTENSILI A BATTERIA

INDUSTRIAL TOTAL

Nome / Famiglia

47042

LAMPADA LED DA LAVORO 20 V, CORPO MACCHINA

Descrizione

Lampada da lavoro 20V, potente Cree led da
1.5W 150 lumens, fascio di luce orientabile

**Tensione della batteria:** 20V**Potenza assorbita:** 1.5W**Lumen:** 150**Batteria e caricatore:** non inclusi

Specifiche tecniche



Codice INECO	Codice Total	Prezzo
470420001	TWLI2023	51.00 €



Nome / Famiglia

47044

PROIETTORE LED DA CANTIERE 20V, CORPO MACCHINA

Descrizione

Proiettore da cantiere con Cree LED da 20W,
due intensità di luce regolabili
(1800 - 900 lumens)

**Tensione della batteria:** 20V**Potenza assorbita:** 20W**Lumens:**

Max: 1800

Min: 900

Batteria e caricatore: non inclusi

Specifiche tecniche



Codice INECO	Codice Total	Prezzo
470440001	TWLI2025	68.00 €

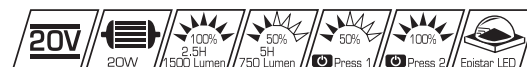

ELETTROUTENSILI A BATTERIA



Nome / Famiglia

47048 BATTERIA AL LITIO 20 V

Descrizione

Batteria al Litio 20V, capacità 2, 4 o 5 Ah, con LED per l'indicazione del livello di carica

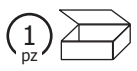

Compatibile con tutti gli elettrodomestici Total con batteria da 20 V



Packaging



Specifiche tecniche

Codice INECO	Codice Total	Capacità	Prezzo
4704800202	TFBLI2001	2 Ah	45.90 €
4704800204	TFBLI2002	4 Ah	77.50 €
4704800205	TFBLI2053	5 Ah	106.00 €

Nome / Famiglia

47049 BATTERIA AL LITIO 12V - 1,5 AH

Descrizione

Tensione della batteria: 12 V
 Capacità della batteria: 1.5 Ah

Compatibile con tutti gli elettrodomestici Total con batteria da 12 V



Packaging



Specifiche tecniche

Codice INECO	Codice Total	Prezzo
4704900012	TBLI12152E	28.30 €



ELETTROUTENSILI A BATTERIA

INDUSTRIAL TOTAL

47050

CARICABATTERIE
PER BATTERIE 20V

Nome / Famiglia

Adatto a tutte le batterie Total da 20 V

Descrizione



Tensione della batteria: 20V
Corrente di carica: 2A
Carica la batteria da 20 V 2,0 Ah in 1 ora



Specifiche tecniche



Codice INECO	Codice Total	Prezzo
4705000001	TFCLI2001E	27.80 €

47070

CARICABATTERIE RAPIDO
PER BATTERIE 20V

Nome / Famiglia

Adatto a tutte le batterie Total da 20 V

Descrizione



Tensione della batteria: 20 V
Corrente di carica: 4 A
Carica la batteria da 20 V 2.0 Ah in mezz'ora



Packaging



Specifiche tecniche



Codice INECO	Codice Total	Prezzo
4707000020	TFCLI2003	43.30 €

P20S 4.0Ah

ELETTROUTENSILI A BATTERIA



Nome / Famiglia

47071
CARICABATTERIE RAPIDO DOPPIO PER BATTERIE 20V

Descrizione

Adatto a tutte le batterie Total da 20 V



Tensione della batteria: 20 V
Corrente di carica: 4 A

Carica la batteria da 20 V 2.0 Ah in mezz'ora



Packaging



Specifiche tecniche



Codice INECO	Codice Total	Prezzo
4707100220	TCLI2024	64.50 €

P20S 4.0Ah

Nome / Famiglia

47074
CARICABATTERIE PER BATTERIE 12V

Descrizione



Tensione del caricatore: 220V-240V~50/60Hz
Tempo di ricarica: 2 ore



Packaging



Specifiche tecniche



Codice INECO	Codice Total	Prezzo
4707400012	TCLI12071E	9.76 €

12V

ELETTROUTENSILI A FILO

472

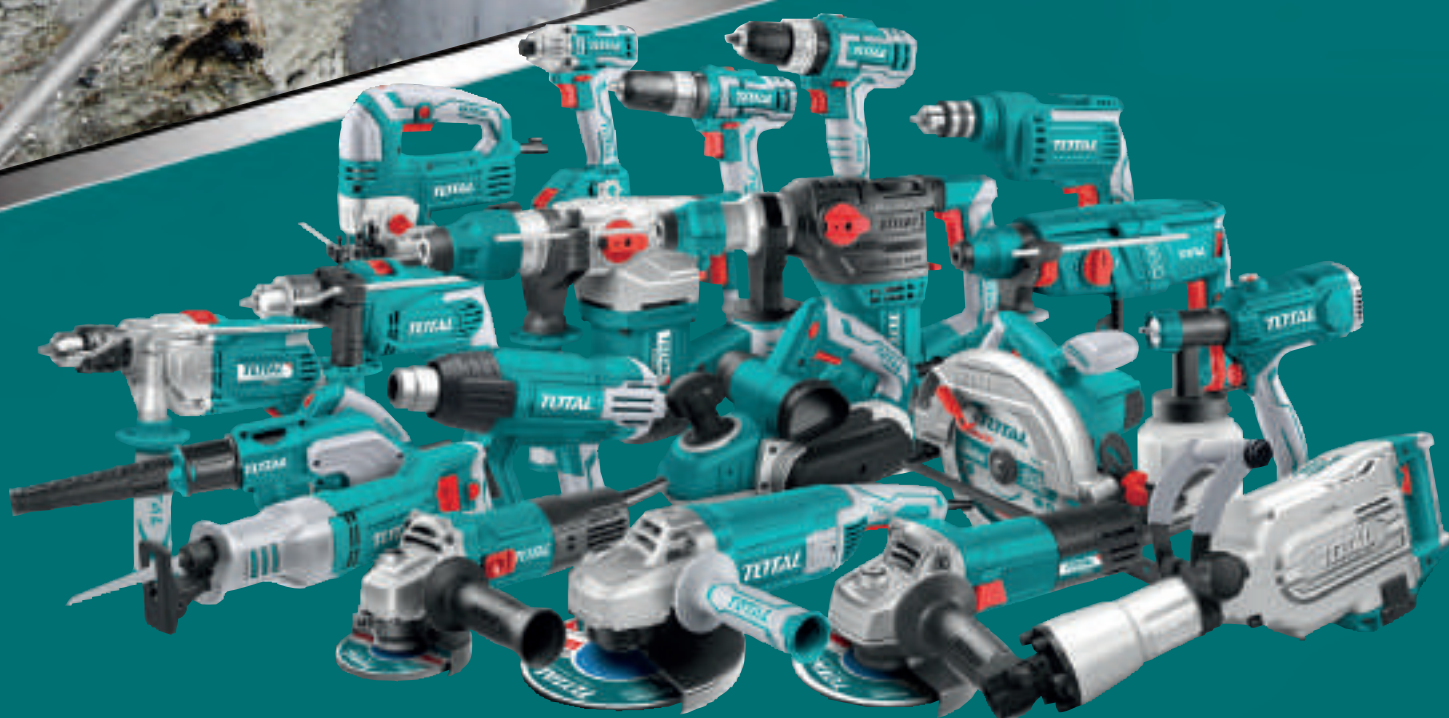

ELETTROUTENSILI A FILO



Nome / Famiglia

47202

TRAPANO A PERCUSSIONE 850 W



Potenza assorbita: 850W
Tensione: 220-240V~50/60Hz
Velocità max: 0-2700rpm
N° colpi/min: 0-43200
Capacità del mandrino: 1,5-13 mm
Diametro foro nel calcestruzzo: 13 mm
Mandrino autoserrante
Velocità variabile
Reversibile

Specifiche tecniche



Codice INECO	Codice Total	Prezzo
4720200850	TG109136-2	71.50 €



ELETTROUTENSILI A FILO

INDUSTRIAL TOTAL

47204

MARTELLINO TASSELLATORE 800 W,
3 FUNZIONI

Nome / Famiglia



Potenza assorbita: 800W
Tensione: 220-240V~50/60Hz
Velocità max: 0-1200 rpm
Numero di colpi: 0-5300 bpm
Potenza del colpo max: 2.5J
Dimensione massima del foro:
 Calcestruzzo: 26mm
 Acciaio: 13mm
 Legno: 30mm
Mandrino SDS-PLUS
Sistema di cambio rapido del mandrino
 3 punte e 2 scalpelli inclusi
 1 mandrino adattatore incluso
 Tre funzioni

5Pcs
Accessories
Free

Specifiche tecniche

Codice INECO	Codice Total	Prezzo
4720400800	TH308268-2	126.00 €



47206

MARTELLINO TASSELLATORE 1050 W,
3 FUNZIONI

Nome / Famiglia



Potenza assorbita: 1050W
Tensione: 220-240V~50/60Hz
Velocità max: 900rpm
Numero di colpi: 4000bpm
Potenza del colpo max: 5J
Dimensione massima del foro:
 Calcestruzzo: 28mm
 Acciaio: 13mm
 Legno: 40mm
Mandrino SDS-PLUS
 3 punte e 2 scalpelli inclusi
 Tre funzioni

SDS
PLUS

Specifiche tecniche

Codice INECO	Codice Total	Prezzo
4720601050	TH110286	133.00 €



ELETTROUTENSILI A FILO

INDUSTRIAL TOTAL

Nome / Famiglia

47208**MARTELLO TASSELLATORE 1500 W, 3 FUNZIONI**

Potenza assorbita: 1500W
Tensione: 220V-240V~50/60Hz
Velocità max: 850rpm
Numero di colpi: 4400bpm
Potenza del colpo max: 5.5J
Dimensione massima del foro:
 Calcestruzzo: 32mm
 Acciaio: 13mm
 Legno: 40mm
Mandrino SDS-PLUS
 3 punte e 2 scalpelli inclusi

SDS PLUS

Specifiche tecniche

INDUSTRIAL

Codice INECO	Codice Total	Prezzo
4720801500	TH115326	167.00 €



ELETTROUTENSILI A FILO

INDUSTRIAL TOTAL

47211

TRONCATRICE DA BANCO 1400W

Nome / Famiglia

Descrizione

Troncatrice da banco 14000 W,
con base in alluminio

Potenza assorbita: 1400 W
Tensione: 220-240V~50/60Hz
Velocità massima: 5000 rpm
Diametro lama: 210 mm
Diametro foro lama: 25,4 mm
Capacità massima di taglio: 55 x 120 mm
 Tagli obliqui 0-45° sinistra e destra
 Tagli inclinati fino a 45° a sinistra
 1 lamaTCT inclusa

Specifiche tecniche



Codice INECO	Codice Total	Prezzo
4721101400	TS42142101	185.50 €



47210

SEGA CIRCOLARE 1400 W

Nome / Famiglia

Descrizione



Potenza assorbita: 1400W
Tensione: 220-240V~50/60Hz
Velocità max: 4800rpm
Diametro lama: 185x20mm
Capacità di taglio:
 45°: 44mm
 90°: 65mm
Profondità di taglio regolabile
Inclinazione di taglio regolabile
 1 lama 185 mm inclusa

Specifiche tecniche



Codice INECO	Codice Total	Prezzo
4721001200	TS1141856	123.50 €



ELETTROUTENSILI A FILO

INDUSTRIAL TOTAL
47212
SEGHETTO ALTERNATIVO 800 W

Nome / Famiglia



Potenza assorbita: 800W
Tensione: 220-240V~50/60Hz
Velocità max: 800-3000rpm
Capacità di taglio:
 Legno: 100mm
 Acciaio: 10mm
Funzione pendolo regolabile su 4 livelli
Base: alluminio
 5 lame incluse
 Righello di guida



Specifiche tecniche

INDUSTRIAL

Codice INECO	Codice Total	Prezzo
4721200800	TS2081006	94.50 €

47214
SEGA A GATTUCCIO 750 W

Nome / Famiglia



Potenza assorbita: 750W
Tensione: 220-240V~50/60Hz
Velocità max: 900-3300rpm
Profondità max. di taglio:
 Legno: 115mm
 Acciaio: 8mm
 Alluminio: 12mm
1 lama per metallo inclusa
1 lama per legno inclusa



Specifiche tecniche

Codice INECO	Codice Total	Prezzo
4721400750	TS100806	104.00 €



ELETTROUTENSILI A FILO



Nome / Famiglia

47218

SMERIGLIATRICE ANGOLARE 950 W, 115 MM



Potenza assorbita: 950W
Tensione: 220-240V~50/60Hz
Velocità max: 11000rpm
Diametro del disco: 115mm
Filettatura dell'alberino: M14
Impugnatura laterale: inclusa



Specifiche tecniche



Codice INECO	Codice Total	Prezzo
47218000950	TG1091156E	79.50 €

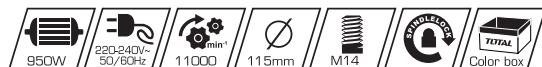

ELETTROUTENSILI A FILO

INDUSTRIAL TOTAL
47220
SMERIGLIATRICE ANGOLARE 950 W, 125 MM

Nome / Famiglia



Potenza assorbita: 950W
Tensione: 220-240V~50/60Hz
Velocità max: 11000rpm
Diametro del disco: 125mm
Filettatura dell'alberino: M14
Impugnatura laterale: inclusa



Specifiche tecniche

INDUSTRIAL

Codice INECO	Codice Total	Prezzo
47220000950	TG1101256E	86.50 €

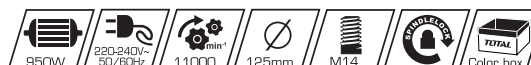
47221
SMERIGLIATRICE ANGOLARE 2400 W, 230 MM

Nome / Famiglia



Potenza assorbita: 2400 W
Tensione della batteria: 220-240V~50/60Hz
Velocità max: 6300 rpm
Diametro del disco: 230 mm
Filettatura alberino: M14
Accessori inclusi: impugnatura laterale
 e 1 set di carboncini di ricambio



Specifiche tecniche

INDUSTRIAL

Codice INECO	Codice Total	Prezzo
47221002400	TG1252306	157.00 €

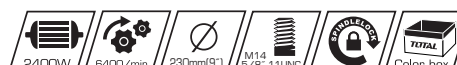

ELETTROUTENSILI A FILO

INDUSTRIAL TOTAL
47224
LEVIGATRICE ORBITALE 320 W

Nome / Famiglia



Potenza assorbita: 320W
Tensione: 220V-240V~50/60Hz
Velocità max: 14000rpm
Dimensione piastra: 180mmx90mm
Base in alluminio



180x90mm

x5pcs

Specifiche tecniche

INDUSTRIAL

Codice INECO	Codice Total	Prezzo
4722400320	TF1301826	69.50 €

47226
LEVIGATRICE ROTORBITALE 450 W

Nome / Famiglia



Potenza assorbita: 450W
Tensione: 220-240V~50/60Hz
Velocità massima: 4000-13000rpm
Diametro del platorello: 150mm
 Platorello con velcro, velocità variabile
 Impugnatura soft



x5pcs

Specifiche tecniche

Codice INECO	Codice Total	Prezzo
4722600450	TF2041506	94.50 €



ELETTROUTENSILI A FILO



Nome / Famiglia

47230

LUCIDATRICE 1400 W



Potenza assorbita: 1400W
Tensione: 220V-240V~50/60Hz
Velocità max: 900-3800rpm
Diametro del platorello: 180mm
 Scatola ingranaggi in alluminio
 1 platorello in gomma incluso
 1 panno lucidante incluso
Attacco: M14



Specifiche tecniche

Codice INECO	Codice Total	Prezzo
4723001400	TP1141806	130.50 €

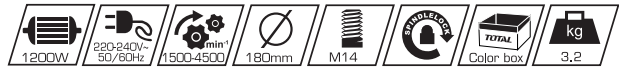

Nome / Famiglia

47216

PIALLA 1050 W



Potenza assorbita: 1050W
Tensione: 220-240V~50/60Hz
Velocità max: 16000rpm
Largezza e profondità della piallatura: 82x3mm
Base in alluminio
Protezione laterale in alluminio
Sistema di raffreddamento automatico
 2 lame incluse
 1 cinghia inclusa
 1 guida parallela inclusa
 1 guida di profondità inclusa



Specifiche tecniche

Codice INECO	Codice Total	Prezzo
4721601050	TL1108236	133.00 €



ELETTROUTENSILI A FILO



Nome / Famiglia

47240

MISCELATORE 1400W



Potenza assorbita: 1400W
Tensione: 220-240V~50/60Hz
Velocità max: 180-480rpm/300-750rpm
Attacco: M14
 Scatola ingranaggi in alluminio
 Luce LED per illuminazione area di lavoro
 1 frusta per miscelatore inclusa



Specifiche tecniche

Codice INECO	Codice Total	Prezzo
4724001400	TD614006	179.00 €

Nome / Famiglia

47608

FRUSTA PER MISCELATORE

Attacco M14x2, lunghezza: 600mm, miscelazione dall'alto verso il basso. Compatibile con miscelatore Total Art. TD614006



Specifiche tecniche

Codice INECO	Codice Total	Diametro		Prezzo
4760800120	TAC331120	120mm	2	19.00 €
4760800160	TAC331160	160mm	2	20.30 €

ELETTROUTENSILI A FILO



47232

TERMOSOFFIATORE 2000 W

Nome / Famiglia

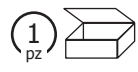

Potenza assorbita: 2000W
Tensione: 220V-240V~50/60Hz
Temperatura di lavoro: 350°C/550°C
Flusso d'aria: 300/500 L/min
 1 raschietto e 3 ugelli inclusi



Specifiche tecniche

Codice INECO	Codice Total	Prezzo
4723202000	TB20036	37.50 €

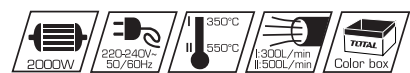

TOTAL

One-Stop Tools Station

ACCESSORI PER ELETTROUTENSILI

474

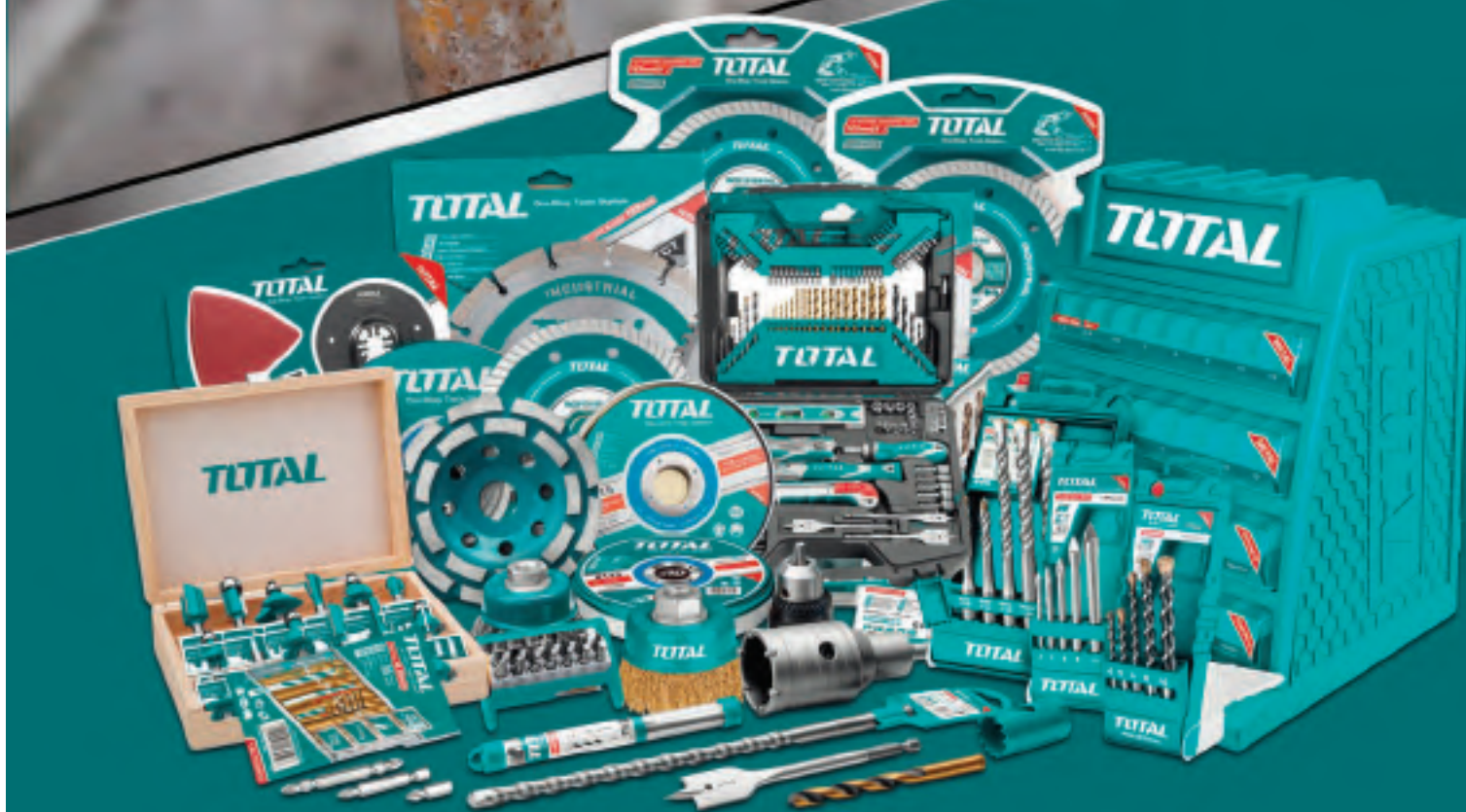

ACCESSORI PER ELETTROUTENSILI



Nome / Famiglia

47402

SET 5 PUNTE PER CALCESTRUZZO



Specifiche tecniche

Codice INECO	Codice Total	Dimensioni (mm)	Prezzo
474020001	TACSD5055	4X75mm 5X85mm 6X100mm 8X120mm 10X120mm	4.82 €

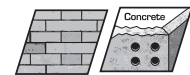

Nome / Famiglia

47404

SET 16 PUNTE ASSORTITE PER MURO, LEGNO E METALLO



Set da 16 punte
 6 punte per metallo
Dimensioni: 2,3,4,5,6,8mm
 5 punte per calcestruzzo
Dimensioni: 4,5,6,8,10mm
 5 punte per legno
Dimensioni: 4,5,6,8,10mm



Specifiche tecniche

Codice INECO	Codice Total	Prezzo
474040001	TACSDL11601	16.45 €

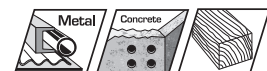

ACCESSORI PER ELETTROUTENSILI

INDUSTRIAL TOTAL

Nome / Famiglia

47406

SET 5 PUNTE PER VETRO E PIASTRELLE



Packaging



Specifiche tecniche

Codice INECO	Codice Total	Dimensioni (mm)	Prezzo
474060001	TACSD7256	4 mm 5 mm 6 mm 8 mm 10 mm	19.00 €

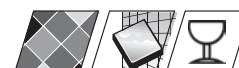

Nome / Famiglia

47408SET 5 PUNTE SDS-PLUS
PER CALCESTRUZZO

Packaging



Specifiche tecniche

Codice INECO	Codice Total	Dimensioni (mm)	Prezzo
474080001	TAC190501	6X110 mm 8X110 mm 8X160 mm 10X160 mm 12X160 mm	14.55 €

ACCESSORI PER ELETTROUTENSILI



Nome / Famiglia

47410

SCALPELLI SDS-PLUS®

Caratt.

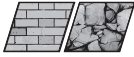

Packaging



Specifiche tecniche

Codice INECO	Codice Total	Ø (mm)	Larghezza (mm)	Lunghezza (mm)		Prezzo
4741000250	TAC1511141	14	0	250	1	4.06 €
4741020250	TAC15121411	14	20	250	1	4.06 €
4741040250	TAC15121412	14	40	250	1	5.70 €

Nome / Famiglia

47412

SCALPELLI SDS-MAX®

Caratt.



Packaging



Specifiche tecniche

Codice INECO	Codice Total	Ø (mm)	Larghezza (mm)	Lunghezza (mm)		Prezzo
4741200400	TAC1521182	18	0	400	1	10.80 €
4741225400	TAC15221821	18	25	400	1	10.80 €
4741250400	TAC15221822	18	50	400	1	12.05 €

ACCESSORI PER ELETTROUTENSILI



Nome / Famiglia

47414

SET FRESA A TAZZA PER MURO, GAMBO SDS-PLUS E PUNTA PILOTA



Diametro: 80mm
Attacco: M22x2
Adattatore 110 mm: incluso
Punta pilota per 8x110 mm: inclusa

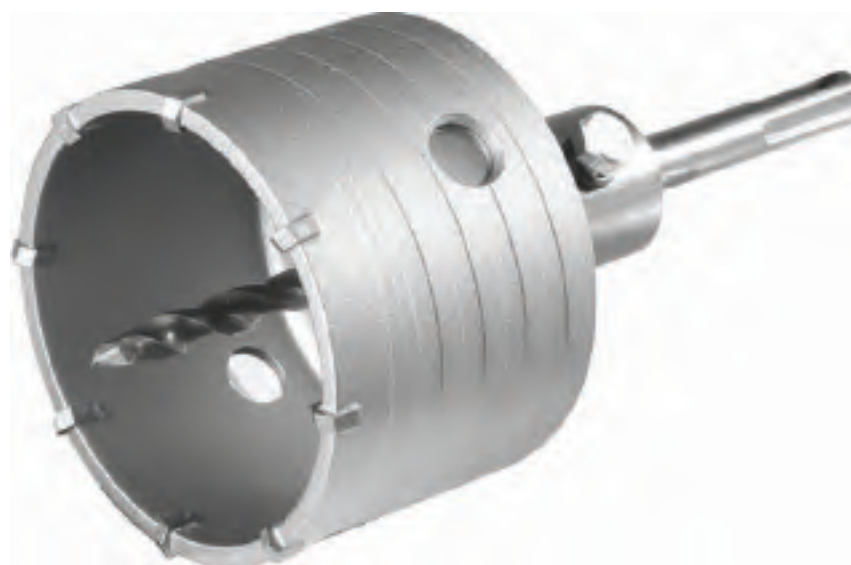

Specifiche tecniche

Codice INECO	Codice Total	Diametro (mm)	Prezzo
4741400050	TAC430501	50 mm	16.45 €
4741400065	TAC430651	65 mm	20.30 €
4741400080	TAC430801	80 mm	24.10 €
4741400100	TAC431001	100 mm	38.00 €

ACCESSORI PER ELETTROUTENSILI



47416

GAMBO 350 MM SDS-PLUS PER FRESA A TAZZA

Nome / Famiglia



Specifiche tecniche

Codice INECO	Codice Total	Attacco	Filetto	Lunghezza	Punta di centraggio	Compatibile con	Prezzo
4741600350	TAC43A13501	PLUS	M22x2	350 mm	8x110 mm	TAC430501 TAC430651 TAC430801 TAC43100	15.20 €

47424

SET 6 PUNTE PER METALLO IN HSS

Nome / Famiglia

Caratt.



Specifiche tecniche

Codice INECO	Codice Total	Dimensioni (mm)	Prezzo
4742400001	TACSD0605	2,3,4,5,6,8	3.94 €

47424

SET 12 PUNTE PER METALLO IN HSS

Nome / Famiglia

Caratt.

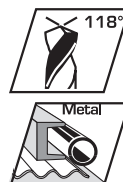

Specifiche tecniche

Codice INECO	Codice Total	Dimensioni (mm)	Prezzo
4742400002	TACSD0125	2,2.5,3,3.5,4,4.5, 5,5.5,6,6.5,7,8	7.86 €

ACCESSORI PER ELETTROUTENSILI



Nome / Famiglia

47426 SET 15 PEZZI SEGHE A TAZZA BIMETALLICHE



Composizione set:
9 tazze dimensioni (mm): 19, 22, 29, 35, 38, 44, 54, 57, 64
1 albero per tazze da 14 a 30 mm
1 albero per tazze da 32 a 210 mm
1 adattatore
3 punte pilota

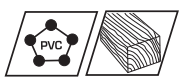

Specifiche tecniche

Codice INECO	Codice Total	Prezzo
4742600001	TACSH0131	108.00 €

Nome / Famiglia

47434 SET 5 PUNTE PER LEGNO

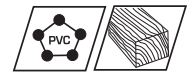
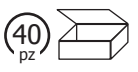

Specifiche tecniche

Codice INECO	Codice Total	Dimensioni (mm)	Prezzo
4743400001	TACSD7055	3x61 4x75 5x86 6x93 8x117	3.80 €

Nome / Famiglia

47436 SET 13 MECCHIE PER LEGNO



Attacco: 1/4" esagonale
 Lunghezza: 152 mm

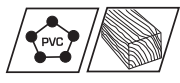

Specifiche tecniche

Codice INECO	Codice Total	Dimensioni (mm)	Prezzo
4743600001	TACSD70131	6, 8, 10, 12, 14, 16, 18, 20, 25, 28, 30, 32, 38	44.30 €

ACCESSORI PER ELETTROUTENSILI



Nome / Famiglia

47438
SET 7 SEGHE A TAZZA PER LEGNO



Packaging



Specifiche tecniche

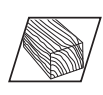

Codice INECO	Codice Total	Dimensioni (mm)	Prezzo
4743800001	TACSH3071	26, 32, 38, 45, 50, 56, 63	8.24 €

Nome / Famiglia

47440
FRESA FORSTNER PER LEGNO

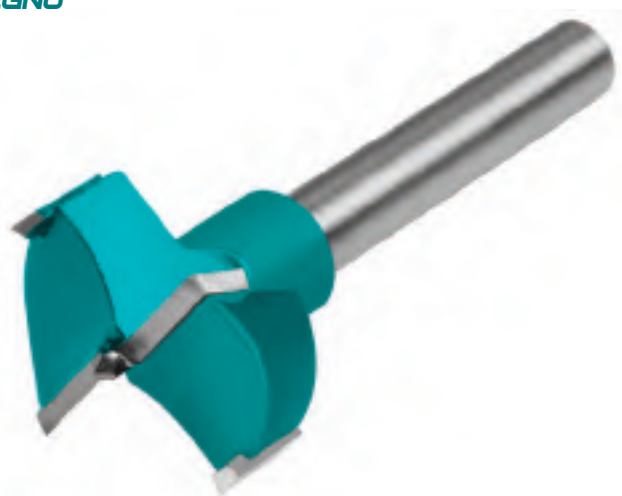

Packaging



Specifiche tecniche

Codice INECO	Codice Total	Ø (mm)		Prezzo
4744000025	TAC180251	25	14	5.70 €
4744000032	TAC180321	32	10	6.96 €
4744000035	TAC180351	35	10	7.60 €

ACCESSORI PER ELETTROUTENSILI

INDUSTRIAL TOTAL

Nome / Famiglia

47444

SET 29 PEZZI INSERTI
E PORTA INSERTI IN BOX

Composizione:

PZ0-1-2-2-3
PH0-1-2-2-3-4
SL3-4-5-6
T10-15-20-25-27-30-40
H3-4-5-6
S1-2-3
1 porta inserti



Specifiche tecniche

Codice INECO	Codice Total	Prezzo
4744400001	TACSD10306	13.95 €

Nome / Famiglia

47445

SET 9 PEZZI INSERTI E PORTA INSERTI



Composizione:

PH1, PH2, PH3, SL4.0, SL5.5, SL6.5, PZ1, PZ2

Materiale: S2 acciaio industriale con magnete
1 porta inserto con attacco rapido e
magnete di trattenimento extra potente



Packaging



Specifiche tecniche

INDUSTRIAL

Codice INECO	Codice Total	Prezzo
4744500001	TACSD3091	5.70 €



ACCESSORI PER ELETTROUTENSILI



Nome / Famiglia

47446

SET 2 PORTA INSERTI MAGNETICI 60MM

25 pz

Packaging

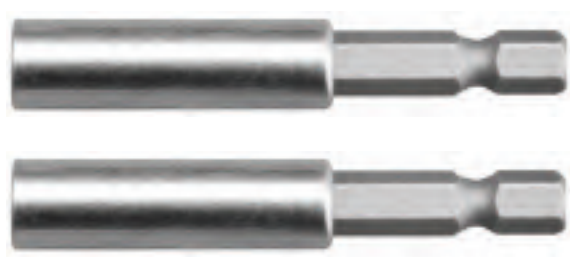

Specifiche tecniche

Codice INECO	Codice Total	Prezzo
4744600001	TAC461601	4.44 €



Nome / Famiglia

47448

SET 5 ESTRATTORI PER VITI DANNEGGIATE

1 pz

Packaging



Specifiche tecniche

Codice INECO	Codice Total	Prezzo
4744800001	TACSE0056	10.15 €

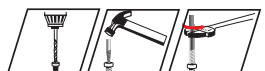

ACCESSORI PER ELETTROUTENSILI



47447

SET 3 ADATTATORI PER BUSSOLE

Nome / Famiglia

Descrizione

Set 3 pezzi adattatori per bussole, misure 1/4"+3/8"+1/2", in acciaio al Cr-V 50BV30

Caratt.



Lunghezza: 65mm (per adattatori 1/4" e 3/8")
Lunghezza: 73mm (per adattatore 1/2")



Packaging



Specifiche tecniche

Codice INECO	Codice Total	Prezzo
4744700001	TAC273651	4.88 €

47452

SET 30 PEZZI PER AVVITATORI AD IMPULSI

Nome / Famiglia

Caratt.



Composizione:
 PH: 1-2-2-2-3
 SL: 3-4-5-6-7
 PZ: 1-2-2-2-3
 T: 10-15-20-25-27-30-40
 H: 3-4-5-6
 S: 1-2-3
 1 portapunte a sgancio rapido



Specifiche tecniche

Codice INECO	Codice Total	Prezzo
4745200001	TACSD18306	23.20 €

ACCESSORI PER ELETTROUTENSILI

INDUSTRIAL TOTAL

47450

SET 45 PEZZI PER AVVITATORI AD IMPULSI

Nome / Famiglia

Descrizione

Inserti, bussole e punte ideali per l'utilizzo
con avvitatori ad impulsi anche di elevata potenza

Caratt.



Packaging

**Composizione:**

- 8 punte giravite 50mm
- 23 punte giravite 25mm
- 1 adattatore
- 2 set punte giravite 89mm
- 5 punte trapano HSS
- 2,3,4,5,6,mm
- 5 bussole magnetiche 48mm
- 6,7,8,9,10mm
- 1 portapunte



Specifiche tecniche

Codice INECO	Codice Total	Prezzo
4745000001	TACSDL24502	41.80 €

ACCESSORI PER ELETTROUTENSILI



47454

LAME PER METALLO PER SEGHETTI ALTERNATIVI

Nome / Famiglia



Per metallo
Lunghezza: 67 mm
Stelo a T
12TPI
Passo progressivo: 1,9-2,3 mm
Materiale: HSS con denti fresati
 Per lamierini con spessore fino a 6 mm
Compatibile con i seghetti alternativi Total Art. TS2081006 e TJSLI8501 e con tutti i seghetti con attacco a T
 Confezione da 5 lame

Packaging



Specifiche tecniche

Codice INECO	Codice Total	Prezzo
4745400001	TAC51118B	5.70 €

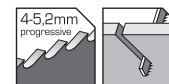

47456

LAME PER LEGNO PER SEGHETTI ALTERNATIVI - TAGLIO VELOCE

Nome / Famiglia



Per legno dolce, multistrato, truciolato, pannelli in fibra
Lunghezza: 74 mm
Taglio veloce
Stelo a T
8TPI
Passo: 3 mm
Materiale: HSS con denti fresati
 Per taglio legno con spessore fino a 50 mm
Compatibile con i seghetti alternativi Total Art. TS2081006 e TJSLI8501 e con tutti i seghetti con attacco a T
 Confezione da 5 lame

Packaging



Specifiche tecniche

Codice INECO	Codice Total	Prezzo
4745600001	TAC51111C	2.80 €



ACCESSORI PER ELETTROUTENSILI



Nome / Famiglia

47456

LAME PER LEGNO PER SEGHETTI ALTERNATIVI - TAGLIO PULITO



Per legno dolce, multistrato, truciolato, pannelli in fibra

Lunghezza: 74 mm

Taglio pulito

Stelo a T

6TPI

Passo progressivo: 4-5,2 mm

Materiale: HSS con denti rettificati

Per taglio legno con spessore fino a 45 mm

Compatibile con i seghetti alternativi Total Art. TS2081006

e TJSLI8501 e con tutti i seghetti con attacco a T

Confezione da 5 lame

Packaging



Specifiche tecniche

Codice INECO	Codice Total	Prezzo
4745600002	TAC51101D	5.06 €



Nome / Famiglia

47460

LAME PER METALLO ATTACCO SABRE® PER SEGHE A GATTOCCIO



Per metallo

Dimensioni: 150x19x0,9 mm

18 TPI

Bi metal con dente fresato

Confezione da 2 pezzi

Compatibile con sega a gattuccio Total Art.

TS100806 e TRSLI1151 e con tutte le seghe con

attacco universale Sabre®

Packaging



Specifiche tecniche

Codice INECO	Codice Total	Prezzo
4746000001	TAC52922EF	5.70 €

ACCESSORI PER ELETTROUTENSILI



Nome / Famiglia

47462

LAME PER LEGNO ATTACCO SABRE® PER SEGHE A GATTOCCIO



Per legno, materiali compositi e plastiche

Dimensioni: 150x19x1,25 mm

6 TPI

HCS con denti fresati

Confezione da 2 pezzi

Compatibile con sega a gattuccio Total Art. TS100806 e

TRSLI1151 e con tutte le seghe con attacco universale Sabre®

Packaging



Specifiche tecniche

Codice INECO	Codice Total	Prezzo
4746200001	TAC52644D	2.54 €

Nome / Famiglia

47464

SET 15 LAME PER UTENSILI MULTIFUNZIONE



Composizione:

1 lama Bi-Metal segmentata diametro 87 mm

1 platorello per levigatura

10 fogli abrasivi

1 lama CrV per taglio legno da 34mm

1 lama Bi-Metal per taglio metallo da 34 mm

1 raschietto

Compatibile con ut. multifunzione Total Art. TMLI2001 e

con gli utensili oscillanti delle migliori marche

Packaging



Specifiche tecniche

Codice INECO	Codice Total	Prezzo
4746400001	TAKTMT1502	22.80 €



ACCESSORI PER ELETTROUTENSILI



Nome / Famiglia

47466
DISCO TAGLIO LEGNO PER SEGHE CIRCOLARI

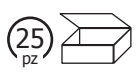

Diametro lama: 185 mm
Diametro foro: 20 mm con riduzione a 16 mm
Numero di denti: 40T
 Per taglio legno
 Compatibile con sega circolare a filo
 Total cod. TS1141856
 (codice Ineco 4721001200)



Packaging



Specifiche tecniche

Codice INECO	Codice Total	Prezzo
4746600185	TAC231415	13.95 €

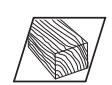

Nome / Famiglia

47466
DISCO TAGLIO LEGNO PER SEGHE CIRCOLARI



Diametro lama: 165 mm
Diametro foro: 20 mm
Numero di denti: 24
 Per taglio legno
 Compatibile con sega circolare a batteria
 Total cod. TSLI1651
 (codice Ineco 470260020)



Packaging



Specifiche tecniche

Codice INECO	Codice Total	Prezzo
4746600165	TAC2323111	10.50 €

ACCESSORI PER ELETTROUTENSILI



47469

DISCO TAGLIO LEGNO PER TRONCATRICI

Nome / Famiglia

Caratt.



Diametro lama: 210 mm
Diametro foro: 30 mm
 con riduzione a 25,4 e 16 mm
Numero di denti: 24
 Per taglio legno
 Compatibile con troncatrice
 Total cod. TS42142101
 (codice Ineco 4721101400)



Packaging



Specifiche tecniche

Codice INECO	Codice Total	Prezzo
4746900210	TAC231521	15.30 €

47468

DISCO TAGLIO ALLUMINIO PER TRONCATRICI

Nome / Famiglia

Caratt.



Diametro lama: 210 mm
Diametro foro: 30 mm
 con riduzione a 25,4 e 16 mm
Numero di denti: 24
 Per taglio alluminio
 Compatibile con troncatrice
 Total cod. TS42142101
 (codice Ineco 4721101400)



Packaging



Specifiche tecniche

Codice INECO	Codice Total	Prezzo
4746800210	TAC233523	24.40 €

ACCESSORI PER ELETTROUTENSILI



Nome / Famiglia

48618**BARRA PER MOTOSEGA****Misura:** 12"**Passo:** 3/8"

Compatibile con motosega

Total TGSLI20128



Packaging



Specifiche tecniche

Codice INECO	Codice Total	Prezzo
4861800001	TGTSB51201	23.00 €

Nome / Famiglia

48620**CATENA PER MOTOSEGA****Misura:** 12"**Passo:** 3/8"

Compatibile con motosega

Total TGSLI20128



Packaging



Specifiche tecniche

Codice INECO	Codice Total	Prezzo
4862000001	TGTSC51201	21.80 €

ACCESSORI PER ELETTROUTENSILI



Nome / Famiglia
 Descrizione

45202 FRESE PER LEGNO

Set frese per legno in valigetta

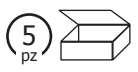

Specifiche tecniche

Codice INECO	Codice Total	Spec	M(mm)	Pezzi	Prezzo
4520200600	TACSR0121	3 frese a taglienti dritti \varnothing 6 mm, 12mm e 16 mm	6	12	40.50 €
		1 fresa per intagli a V a 90° \varnothing 12,7 mm			
		1 fresa per unioni a coda di rondine \varnothing 12,7 mm			
4520200800	TACSR1121	1 fresa per smussare a 45° \varnothing 32 mm	8	12	40.50 €
		1 fresa per rifilare \varnothing 12,7 mm			
		2 frese a raggio concavo 6,35 mm e 9,50 mm			
4520201200	TACSR2121	1 fresa a raggio convesso 6,35 mm	12	12	40.50 €
		1 fresa profilata			

ACCESSORI PER ELETTROUTENSILI **INDUSTRIAL TOTAL**

Nome / Famiglia

47488

FOGLI ABRASIVI PER LEVIGATRICI ORBITALI



Dimensioni: 90x231 mm (per piastre 90x180 mm)
3 fogli P80
2 fogli P120
Compatibile con levigatrice Total Art. TF1301823



Specifiche tecniche

Codice INECO	Codice Total	Prezzo
4748890231	TAC749241-1	1.40 €



Nome / Famiglia

47490

SET 5 DISCHI ABRASIVI PER LEVIGATRICI ROTORBITALI



Specifiche tecniche

Codice INECO	Codice Total	Dimensioni (mm)	Fori	Pezzi per grana	Compatibilità	Icona	Prezzo
4749000150	TAC731501	150	8	3xP80, 2xP210	TF2041501		3.18 €
4749000125	TAC731251	125	8	3xP80, 2xP210	TF2031256 TROSLI2001		2.80 €

ACCESSORI PER ELETTROUTENSILI



Nome / Famiglia

47492

PLATORELLO PER LUCIDATRICE

Packaging



Diametro: 180mm
Materiale: Gomma
Attacco M14
N° max giri: 4000 rpm
Compatibile con lucidatrice Total Art. TP1141806



Specifiche tecniche

Codice INECO	Codice Total	Prezzo
4749200180	TAC7111801	10.15 €

Nome / Famiglia

47494

PANNO PER LUCIDATRICI

Packaging



Diametro: 180mm
Compatibile con platorello Art. Total TAC7110801 per lucidatrice Art. TP1141806



Specifiche tecniche

Codice INECO	Codice Total	Prezzo
4749400180	TAC721801	8.86 €

Nome / Famiglia

47496

LAME PER PIALLA ELETTRICA

Packaging



Dimensioni: 82x5.5x1.2mm
Compatibile con pialletto Total Art. UTL1108236



Specifiche tecniche

Codice INECO	Codice Total	Prezzo
4749600001	TAC618201	5.06 €

Nome / Famiglia

47608

FRUSTA PER MISCELATORE

Attacco M14x2
 Compatibile con miscelatore Total Art. TD614006



Specifiche tecniche

Codice INECO	Codice Total	Misure	Icona	Prezzo
4760800120	TAC331120	120mm	2	19.00 €
4760800160	TAC331160	160mm	2	20.30 €

ACCESSORI PER ELETTROUTENSILI

INDUSTRIAL TOTAL

Nome / Famiglia

47602

**MANDRINO A
CREMAGLIERA CON
ATTACCO 1/2X20 UNF ED
ADATTATORE SDS-PLUS**

1
pz



Packaging



Specifiche tecniche

Codice INECO	Codice Total	Prezzo
4760201220	TAC451301.1	10.15 €

Nome / Famiglia

47604

**CHIAVE PER MANDRINI
A CREMAGLIERA**

25
pz



Packaging



Specifiche tecniche

Codice INECO	Codice Total	Prezzo
4760400001	TAC470131	2.54 €

Nome / Famiglia

47606

**MANDRINO
AUTOSERRANTE
ATTACCO 1/2X20 UNF**

1
pz



Packaging



Specifiche tecniche

Codice INECO	Codice Total	Prezzo
4760601220	TAC451321	11.40 €

Nome / Famiglia

47236

STICK COLLA A CALDO

10
pz

Diametro: 11.2mm
Lunghezza: 20cm
Confezione da 6 pezzi



Specifiche tecniche

Codice INECO	Codice Total	Prezzo
4723600006	TACGT2061	4.12 €

ACCESSORI PER ELETTROUTENSILI



45016

PISTOLA SOFFIAGGIO CANNA CORTA

Nome / Famiglia

Descrizione

Pistola soffiaggio in metallo, canna corta, con attacco rapido



Packaging



Specifiche tecniche



Codice INECO	Codice Total	Prezzo
4501600001	TAT3031	6.34 €

45018

PISTOLA GONFIAGGIO

Nome / Famiglia

Descrizione

Pistola di gonfiaggio con manometro, attacco rapido, pressione max. 12 bar



Specifiche tecniche

Codice INECO	Codice Total	Pressione	Prezzo
4501800001	TAT11601	12 Bar	20.00 €

ACCESSORI PER ELETTROUTENSILI

INDUSTRIAL TOTAL

Nome / Famiglia

45020

TUBI SPIRALATI

Descrizione

Tubo spiralato in nylon, 5x8 mm,
con attacchi rapidi



Specifiche tecniche

Codice INECO	Codice Total	L (m)	D (mm)	Prezzo
4502000050	THT11051	5	5/8	11.30 €
4502000100	THT11101	10	5/8	17.60 €
4502000015	THT11151	15	5/8	24.00 €

Nome / Famiglia

45022

SET 5 PEZZI ACCESSORI PER COMPRESSORI, SUPER SELECT

Caratt.



Tubo spiralato:
Lunghezza 4 m, diametro 8 mm

Pistola di soffiaggio canna corta:
Lunghezza ugello 16 mm

Pistola per verniciatura:
Pressione 3-4 bar, capacità vernice 600 cc
Larghezza 180-250 mm

Pistola per lavaggio ad aria:
Pressione 4 bar, capacità di lavaggio 750 cc

Pistola di gonfiaggio:
Pressione massima 12 bar

Compatibili solo con attacco europeo

Specifiche tecniche

Codice INECO	Codice Total	Prezzo
4502200001	TATK053	50.50 €



PINZE E TRONCHESI

416

Fulcro più vicino ai
taglianti per uno
**sforzo del 30%
inferiore** rispetto
al modello standard

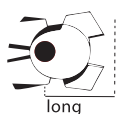

Asole
di **aggancio**

Impugnatura
ergonomica
bimateriale



41604

**PINZA
UNIVERSALE
A GRANDE
EFFETTO**

Pinza universale a grande
effetto, impugnatura
ergonomica bimateriale,
finitura nera e lucida

PINZE E TRONCHESI

INDUSTRIAL TOTAL

Nome / Famiglia

41602

PINZA UNIVERSALE

Descrizione

Pinza universale con impugnatura ergonomica bimatériale, finitura nera e lucida

Caratt.



Packaging



Specifiche tecniche

Codice INECO	Codice Total	Lunghezza (mm)	Prezzo
4160200160	THT210606	160(6")	8.74 €
4160200180	THT210706	180(7")	9.76 €
4160200200	THT210806	200(8")	11.05 €

Nome / Famiglia

41604

PINZA UNIVERSALE A GRANDE EFFETTO

Descrizione

Pinza universale a grande effetto, impugnatura ergonomica bimatériale, finitura nera e lucida

Caratt.



Packaging



short



long

Specifiche tecniche

Codice INECO	Codice Total	Lunghezza (mm)	Prezzo
4160400180	THT210706S	180(7")	11.40 €
4160400200	THT210806S	200(8")	12.30 €

PINZE E TRONCHESI

INDUSTRIAL TOTAL

Nome / Famiglia

41606

PINZA BECCHI LUNGI MEZZITONDI

Descrizione

Pinza a becchi semitondi lunghi, impugnatura ergonomica bimatériale, finitura nera e lucida

Caratt.



Packaging



Specifiche tecniche



Codice INECO	Codice Total	Lunghezza (mm)	Prezzo
4160600160	THT220606	160(6")	7.98 €

Nome / Famiglia

41608

PINZA BECCHI LUNGI MEZZITONDI A GRANDE EFFETTO

Descrizione

Pinza a becchi semitondi lunghi a grande effetto, impugnatura ergonomica bimatériale, finitura nera e lucida

Caratt.



Packaging

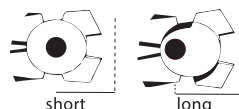

Specifiche tecniche

Codice INECO	Codice Total	Lunghezza (mm)	Prezzo
4160800160	THT220606S	160(6")	9.38 €
4160800200	THT220806S	200(8")	10.40 €

Nome / Famiglia

41610

PINZA BECCHI MEZZITONDI CURVI

Descrizione

Pinza a becchi semitondi lunghi piegati, impugnatura ergonomica bimatériale, finitura nera e lucida

Caratt.



Packaging



Specifiche tecniche

Codice INECO	Codice Total	Lunghezza (mm)	Prezzo
4161000160	THT24616	160(6")	7.98 €

TOTAL

One-Stop Tools Station

PINZE E TRONCHESI

INDUSTRIAL TOTAL

Nome / Famiglia

41612**SET 3 PINZE**

Descrizione

Set tre pinze composto da una pinza universale, un tronchese diagonale e una pinza a becchi semitondi lunghi, impugnature ergonomiche bimateriale, finiture nere e lucide

Caratt.

5
pz

Specifiche tecniche



Codice INECO	Codice Total	Prezzo
4161200001	THT2K0301	25.30 €



Nome / Famiglia

41613**SET 3 PINZE A GRANDE EFFETTO**

Descrizione

Set tre pinze a grande effetto composto da una pinza universale, un tronchese diagonale e una pinza a becchi semitondi lunghi, impugnature ergonomiche bimateriale, finiture nere e lucide

Caratt.

5
pz

Specifiche tecniche



- 1 pinza universale a grande effetto **200 mm**
- 1 pinza becchi lunghi a grande effetto **160 mm**
- 1 tronchese diagonale a grande effetto **180 mm**

Il fulcro più vicino ai taglienti consente una riduzione dello sforzo del 30% rispetto al modello standard.

Codice INECO	Codice Total	Prezzo
4161300002	THT2K0301S	27.90 €



PINZE E TRONCHESI



Nome / Famiglia

41614

TRONCHESE DIAGONALE

Descrizione

Tronchese con taglienti diagonali, impugnatura ergonomica bimatériale, finitura nera e lucida

Caratt.

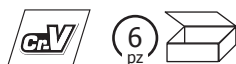

Packaging



Specifiche tecniche

Codice INECO	Codice Total	Lunghezza (mm)	Prezzo
4161400160	THT230606	160(6")	8.10 €
4161400180	THT230706	180(7")	9.38 €

Nome / Famiglia

41615

TRONCHESE DIAGONALE LEVA LUNGA

Descrizione

Tronchese con taglienti diagonali per lavori gravosi, impugnatura ergonomica bimatériale, finitura nera e lucida

Caratt.



Packaging



Specifiche tecniche

Codice INECO	Codice Total	Lunghezza (mm)	Prezzo
4161500180	THT27716	180(7")	10.15 €

Nome / Famiglia

41616

TRONCHESE DIAGONALE A GRANDE EFFETTO

Descrizione

Tronchese a taglienti diagonali a grande effetto, impugnatura ergonomica bimatériale, finitura nera e lucida

Caratt.



Packaging



Specifiche tecniche

Codice INECO	Codice Total	Lunghezza (mm)	Prezzo
4161600160	THT230606S	160(6")	10.15 €
4161600180	THT230706S	180(7")	10.65 €

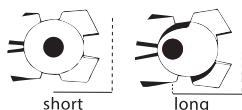

Nome / Famiglia

41618

TRONCHESE DIAGONALE LEVA LUNGA E GRANDE EFFETTO

Descrizione

Tronchese a taglienti diagonali a grande effetto, maggiore leva per i lavori più intensi, impugnatura ergonomica bimatériale, finitura nera e lucida

Caratt.



Packaging



Specifiche tecniche

Codice INECO	Codice Total	Lunghezza (mm)	Prezzo
4161800180	THT27716S	180(7")	11.40 €

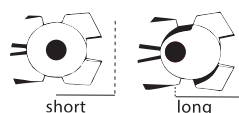

PINZE E TRONCHESI



Nome / Famiglia

41620

TRONCHESE FRONTALE

Descrizione

Tronchese con taglienti frontali, impugnatura ergonomica bimatériale, finitura nera e lucida

Caratt.



6 pz



Packaging



Specifiche tecniche

Codice INECO	Codice Total	Lunghezza (mm)	Prezzo
4162000160	THT260606	160(6")	10.00 €

Nome / Famiglia

41622

SET PINZE PER ANELLI ELASTICI

Descrizione

Set 4 pinze per anelli con impugnatura antiscivolo

5 pz



2 pinze 180 mm con becchi dritti
 2 pinze 180 mm con becchi a 90°

Specifiche tecniche

In acciaio al carbonio, con manici gommati.

Codice INECO	Codice Total	Lunghezza (mm)	Prezzo
4162200001	THT114041	180(7")	23.50 €

Nome / Famiglia

41622

SET 4 PINZE PER ANELLI USO INTENSIVO

Descrizione

Set 4 pinze per anelli con impugnatura antiscivolo

5 pz



Packaging



Specifiche tecniche

Codice INECO	Codice Total	Prezzo
4162200002	THTJ214042	44.30 €

PINZE E TRONCHESI



Nome / Famiglia

41624

PINZA REGOLABILE CERNIERA CHIUSA

Descrizione

Pinza regolabile a cerniera chiusa, impugnatura ergonomica bimateriale, finitura nera e lucida

Caratt.

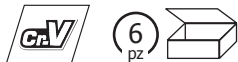

Specifiche tecniche

Codice INECO	Codice Total	Lunghezza (mm)	Prezzo
4162400250	THT281006	250(10")	11.05 €



Packaging



Nome / Famiglia

41625

PINZA REGOLABILE CERNIERA CHIUSA 300 MM

Descrizione

Pinza regolabile cerniera chiusa, al cromo-vanadio, finitura nera e lucida, impugnatura ergonomica in gomma



Specifiche tecniche

Codice INECO	Codice Total	Lunghezza (mm)	Prezzo
4162500300	THT281202	300 (12")	14.25 €



Packaging



PINZE E TRONCHESI

INDUSTRIAL TOTAL

Nome / Famiglia

41626

PINZA REGOLABILE CON PULSANTE

Descrizione

Pinza regolabile con pulsante di blocco, impugnatura ergonomica bimateriale, finitura nera e lucida

3X FASTER
 Quick-adjusting lower jaw

Specifiche tecniche

Codice INECO	Codice Total	Lunghezza (mm)	Prezzo
4162600250	THTJ381006	250 mm	20.30 €

Packaging



Nome / Famiglia

41627

PINZA REGOLABILE APERTURA 50 MM

Descrizione

Pinza regolabile a cerniera chiusa, impugnatura ergonomica bimateriale, finitura nera e lucida



Specifiche tecniche

Codice INECO	Codice Total	Lunghezza (mm)	Prezzo
4162700250	THT281005	250 mm	11.40 €

Packaging



PINZE E TRONCHESI

INDUSTRIAL TOTAL

Nome / Famiglia

41630**PINZA AUTOBLOCCANTE**

Descrizione

Pinza regolabile autobloccante ganasce concave

6 pz

Packaging



Specifiche tecniche

Codice INECO	Codice Total	Lunghezza (mm)	Prezzo
4163000175	THT190703	175(7")	7.22 €

Nome / Famiglia

41630**PINZA AUTOBLOCCANTE**

Descrizione

Pinza regolabile autobloccante ganasce concave

6 pz

Packaging



Specifiche tecniche

Codice INECO	Codice Total	Lunghezza (mm)	Prezzo
4163010254	THT191003	250(10")	8.74 €

Nome / Famiglia

41630**PINZA AUTOBLOCCANTE**

Descrizione

Pinza autobloccante ganasce dritte

5 pz

Packaging



Specifiche tecniche

Codice INECO	Codice Total	Lunghezza (mm)	Prezzo
4163020254	THT191002	250(10")	8.74 €

Nome / Famiglia

41630**PINZA AUTOBLOCCANTE**

Descrizione

Pinza autobloccante becchi lunghi

5 pz

Packaging

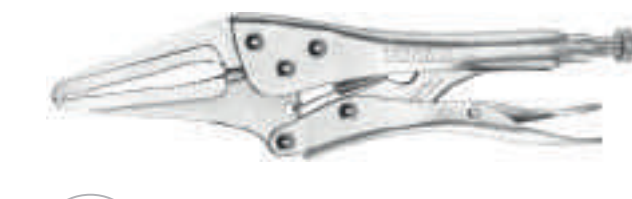

Specifiche tecniche

Codice INECO	Codice Total	Lunghezza (mm)	Prezzo
4163000228	THT19902	228(9")	8.36 €

PINZE E TRONCHESI



Nome / Famiglia
41638
PINZA AUTOBLOCCANTE A MORSETTO

Descrizione
 Pinza autobloccante a morsetto, in acciaio al carbonio, con rivestimento al nichel



Packaging



Specifiche tecniche

Codice INECO	Codice Total	Lunghezza (mm)	Prezzo
4163800280	THT111113	280 (11")	13.70 €

Nome / Famiglia
41636
PINZA AUTOBLOCCANTE PER SALDATURE

Descrizione
 Pinza autobloccante in acciaio al carbonio, con rivestimento al nichel



Packaging



Specifiche tecniche

Codice INECO	Codice Total	Lunghezza (mm)	Prezzo
4163600250	THT1921003	250(10")	16.90 €

Nome / Famiglia
41634
PINZA FUSTELLATRICE

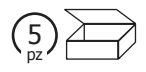

Packaging



Specifiche tecniche

Codice INECO	Codice Total	Foro perforazione (")	Prezzo
4163400001	THT3351	2.5, 3, 3.5, 4, 4.5, 5	10.15 €

PINZE E TRONCHESI

INDUSTRIAL TOTAL

Nome / Famiglia

41640**MINI PINZA UNIVERSALE**

Caratt.

115mm
(4,5")12
pz

Packaging



Specifiche tecniche

Codice INECO	Codice Total	Lunghezza (mm)	Prezzo
4164000115	THTMN156	115 (4,5")	4.64 €

Nome / Famiglia

41642**MINI PINZA BECCHI LUNGI MEZZITONDI**

Caratt.

115mm
(4,5")12
pz

Packaging



Specifiche tecniche

Codice INECO	Codice Total	Lunghezza (mm)	Prezzo
4164200115	THTMN256	115 (4,5")	4.64 €

PINZE E TRONCHESI

INDUSTRIAL TOTAL

Nome / Famiglia

41643**MINI PINZA BECCHI MEZZITONDI CURVI**

Caratt.

115mm
(4.5")12
pz

Packaging



Specifiche tecniche

Codice INECO	Codice Total	Lunghezza (mm)	Prezzo
4164300115	THTMN456	115 (4,5")	4.64 €

Nome / Famiglia

41644**MINI PINZA BECCHI TONDI**

Caratt.

115mm
(4.5")12
pz

Packaging



Specifiche tecniche

Codice INECO	Codice Total	Lunghezza (mm)	Prezzo
4164400115	THTMN656	115 (4,5")	4.64 €

PINZE E TRONCHESI

INDUSTRIAL TOTAL

Nome / Famiglia

41645**MINI PINZA BECCHI AD AGO**

Caratt.

115mm
(4,5")12
pz 

Packaging



Specifiche tecniche

Codice INECO	Codice Total	Lunghezza (mm)	Prezzo
4164500115	THTMN756	115 (4,5")	4.64 €

Nome / Famiglia

41647**MINI PINZA BECCHI PIATTI**

Caratt.

115mm
(4,5")12
pz 

Packaging



Specifiche tecniche

Codice INECO	Codice Total	Lunghezza (mm)	Prezzo
4164700115	THTMN856	115 (4,5")	4.64 €

PINZE E TRONCHESI

INDUSTRIAL TOTAL

Nome / Famiglia

41641**MINI TRONCHESE DIAGONALE**

Caratt.

115mm
(4.5")12
pz 

Packaging



Specifiche tecniche

Codice INECO	Codice Total	Lunghezza (mm)	Prezzo
4164100115	THTMN356	115 (4,5")	4.64 €

Nome / Famiglia

41646**MINI TRONCHESE FRONTALE**

Caratt.

115mm
(4.5")12
pz 

Packaging



Specifiche tecniche

Codice INECO	Codice Total	Lunghezza (mm)	Prezzo
4164600115	THTMN556	115 (4,5")	4.64 €

PINZE E TRONCHESI



Nome / Famiglia

41648

SET 6 MINI PINZE

Descrizione

Set di 6 pinze mini, super select

Caratt.



- 1 mini pinza universale 4.5"
- 1 mini tronchese diagonale 4.5"
- 1 mini tronchese frontale 4.5"
- 1 mini pinza becchi lunghi mezzitondi 4.5"
- 1 mini pinza becchi piatti 4.5"
- 1 mini pinza becchi ad ago 4.5"

Specifiche tecniche

Codice INECO	Codice Total	Prezzo
4164800001	THT1K0511	21.80 €



GIRAVITI

418

Acciaio Cr-V
per la massima
resistenza all'usura

Impugnatura
ergonomica
bimateriale



41806

**GIRAVITE PER
VITI CON
IMPRONTA A
CROCE PHILLIPS™**

Giravite per viti con impronta a croce Phillips™, impugnatura ergonomica bimateriale, lama in acciaio al Cr-V

GIRAVITI**INDUSTRIAL TOTAL**

Nome / Famiglia

41802**GIRAVITE PER VITI CON INTAGLIO**

Descrizione

Giravite per viti a testa con intaglio, impugnatura ergonomica bimateriale, lama in acciaio al Cr-V

Caratt.



Packaging



Specifiche tecniche

Codice INECO	Codice Total	Ø	Ø(mm)	Lmm	Prezzo
4180240100	THT264100	4mm	4	100	1.78 €
4180255075	THT265075	5.5mm	5	75	1.90 €
4180255100	THT265100	5.5mm	5	100	2.04 €
4180265125	THT266125	6.5mm	6	125	2.80 €
4180265150	THT266150	6.5mm	6	150	2.92 €
4180280150	THT628150	8mm	8	150	4.06 €
4180280200	THT268200	8mm	8	200	4.70 €

Nome / Famiglia

41806**GIRAVITE PER VITI CON IMPRONTA
A CROCE PHILLIPS™**

Descrizione

Giravite per viti con impronta a croce Phillips™, impugnatura ergonomica bimateriale, lama in acciaio al Cr-V

Caratt.

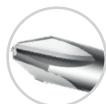

Packaging



Specifiche tecniche

Codice INECO	Codice Total	Ø	Ø(mm)	Lmm	Prezzo
4180600075	THT26PH0075	PH0	3.0	75	1.40 €
4180601075	THT26PH1075	PH1	5.0	75	1.90 €
4180601100	THT26PH1100	PH1	5.0	100	2.04 €
4180602125	THT26PH2125	PH2	6.0	125	2.80 €
4180602150	THT26PH2150	PH2	6.0	150	2.92 €
4180603150	THT26PH3150	PH3	8.0	150	3.80 €
4180603200	THT26PH3200	PH3	8.0	200	4.56 €

GIRAVITI**INDUSTRIAL TOTAL**

Nome / Famiglia

41802**GIRAVITE CORTO PER VITI
CON INTAGLIO**

Descrizione

Giravite corto per viti a testa con intaglio, impugnatura ergonomica bimateriale, lama in acciaio al Cr-V

Caratt.



Packaging



Specifiche tecniche



Codice INECO	Codice Total	⊖	Ø(mm)	Lmm	Prezzo
4180265038	THT266038	6,58mm	6	38	2.16 €

Nome / Famiglia

41806**GIRAVITE CORTO PER VITI
CON IMPRONTA A CROCE
PHILLIPS™**

Descrizione

Giravite corto per viti con impronta a croce Phillips™, impugnatura ergonomica bimateriale, lama in acciaio al Cr-V

Caratt.



Packaging



Specifiche tecniche

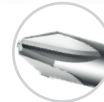

Codice INECO	Codice Total	⊕	Ø(mm)	Lmm	Prezzo
4180602038	THT26PH2038	PH2	6.0	38	2.16 €

Nome / Famiglia

41810**GIRAVITE CON IMPRONTA
A CROCE POZIDRIV™**

Descrizione

Giravite per viti con impronta a croce Pozidriv™, impugnatura ergonomica bimateriale, lama in acciaio al Cr-V

Caratt.



Packaging



Specifiche tecniche



Codice INECO	Codice Total	⊕	Ø(mm)	Lmm	Prezzo
4181001100	THT26PZ1100	PZ1	5.0	100	2.04 €
4181002150	THT26PZ2150	PZ2	6.0	150	2.92 €

Nome / Famiglia

41812**GIRAVITE PER VITI
IMPRONTA TORX™**

Descrizione

Giravite per viti con impronta Torx™, impugnatura ergonomica bimateriale, lama in acciaio al Cr-V

Caratt.



Packaging



Specifiche tecniche



Codice INECO	Codice Total	⊕	Ø(mm)	Lmm	Prezzo
4181210100	THT26T10100	T10	5	100	2.04 €
4181220150	THT26T20150	T20	6	150	2.92 €

GIRAVITI**INDUSTRIAL TOTAL**

Nome / Famiglia

41814**SET 2 GIRAVITI INTAGLIO
E PHILLIPS**

Descrizione

Lame in acciaio al Cr-V, punte brunate e
magnetiche, manici ergonomici bimateriale

Caratt.

10
pz1 pz SL6.5x6x125
1 pz PH2x6x125

Specifiche tecniche

Lame in acciaio al Cr-V, punte brunate e
magnetiche, manici ergonomici bimateriale

Codice INECO	Codice Total	Spec	Prezzo
4181400002	THT250201	1pz SL6.5x6x125mm	5.58 €
		1pz PH2x6x125mm	

Packaging



Nome / Famiglia

41814**SET 6 GIRAVITI INTAGLIO
E PHILLIPS™**

Descrizione

Set 6 giraviti per viti con intaglio ed impronta
a croce Phillips™, impugnatura ergonomica
bimateriale, lama in acciaio al Cr-V

Caratt.

5
pz

Specifiche tecniche

Codice INECO	Codice Total	Spec	Prezzo
4181400006	THT250606	1pz SL5.5x5x75mm	12.30 €
		1pz SL5.5x5x100mm	
		1pz SL6.5x6x150mm	
		1pz PH1x5x75mm	
		1pz PH1x5x100mm	
		1pz PH2x6x150mm	



GIRAVITI**INDUSTRIAL TOTAL****41814****SET 8 GIRAVITI INTAGLIO
E PHILLIPS™**

Nome / Famiglia

Descrizione

Caratt.

Set 8 giraviti per viti con intaglio ed impronta a croce Phillips™, impugnatura ergonomica bimateriale, lama in acciaio al Cr-V



Specifiche tecniche

Codice INECO	Codice Total	Spec	Prezzo
4181400008	THT250608	1pz SL3.0x3x75mm	16.45 €
		1pz SL5.5x5x100mm	
		1pz SL6.5x6x150mm	
		1pz SL6.5x6x38mm	
		1pz PH0x3x75mm	
		1pz PH1x5x75mm	
		1pz PH2x6x125mm	
		1pz PH2x6x38mm	



Nome / Famiglia

41814**SET 10 GIRAVITI INTAGLIO
E PHILLIPS™**

Descrizione

Caratt.

Set 10 giraviti per viti con intaglio ed impronta a croce Phillips™, impugnatura ergonomica bimateriale, lama in acciaio al Cr-V



Specifiche tecniche

Codice INECO	Codice Total	Spec	Prezzo
4181400010	THT250610	1pz SL3.0x3x75mm	25.30 €
		1pz SL4.0x4x100mm	
		1pz SL5.5x5x125mm	
		1pz SL6.5x6x150mm	
		1pz SL8.0x8x200mm	
		1pz SL6.5x6x38mm	
		1pz PH0x3x60mm	
		1pz PH1x5x80mm	
		1pz PH2x6x100mm	
		1pz PH3x8x150mm	



GIRAVITI

INDUSTRIAL TOTAL

41814

SET 18 GIRAVITI E GIRAVITI DI PRECISIONE ASSORTITI

Nome / Famiglia

Descrizione

Set 18 giraviti e giraviti di precisione assortiti, per viti con intaglio ed impronta a croce Phillips™, impugnatura ergonomica bimateriale, lama in acciaio al Cr-V, con pratico supporto in plastica

Caratt.

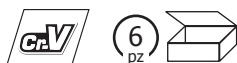

8 giraviti per viti con intaglio e con impronta a croce Phillips™

- 1pz SL5.5x5x75
- 1pz SL6.5x6x100
- 1pz SL8.0x8x150
- 1pz SL6.5x6x38

- 1pz PH1x5x75
- 1pz PH2x6x100
- 1pz PH3x8x150
- 1pz PH2x6x38

10 giraviti di precisione per viti con intaglio, impronta a croce Phillips™ e Torx™

- SL1.5x50 SL2x50 SL2.5x50 SL3x50
- PH000x50 PH00x50 PH0x50
- T6x50 T8x50 T10x50

Specifiche tecniche

Codice INECO	Codice Total	Prezzo
4181400018	THT250618	30.20 €



41814

SET 7 GIRAVITI DI PRECISIONE IN BOX

Nome / Famiglia

Descrizione

Set 7 giraviti di precisione per viti con intaglio, impronta a croce Phillips™ e Torx™, manici ergonomici bimateriale, lame in acciaio al Cr-V

Caratt.

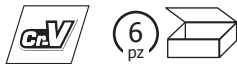

Specifiche tecniche

Codice INECO	Codice Total	Spec	Prezzo
4181400001	THT250726	3 giraviti per viti con intaglio SL2.0x50,SL2.5x50,SL3.0x50	10.80 €
		2 giraviti per viti con impronta Phillips™: PH00x50,PH0x50	
		2 giraviti per viti con impronta Torx™: T6x50,T8x50	



GIRAVITI**INDUSTRIAL TOTAL**

Nome / Famiglia

41818**SET 100 PEZZI PER AVVITATURA**

Descrizione

Set di giraviti da 100 pezzi al Cromo-Vanadio

Caratt.



8 giraviti intaglio
SL3x75, SL4x100, SL5x75, SL5x100
SL5x125, SL6x100, SL6x150, SL8x150

8 giraviti Phillips™
PH0x75, PH0x100, PH1x75, PH1x100
PH1x150, PH2x100, PH2x150, PH3x150

3 giraviti Torx™
T10x100x3, T15x100x3.5, T20x100x4

3 giraviti Pozidriv™
PZ0x100, PZ1x100, PZ2x100

1 porta inserti magnetico
7x100

1 punteruolo
3x75

8 giraviti di precisione
SL1.5x50, SL2.5x50, PH000x50, PH00x50
PH0x50, T6x50, T8x50, T10x50

60 inserti
2 pz SL3, 2 pz SL4, 3 pz SL5, 3pz SL6
2 pz SL7, 2 pz PH0, 3pz PH1, 3pz PH2
2pz PH3, 2pz PZ0, 3pz PZ1, 3pz PZ2
2pz PZ3, 1pz 1.5, 1pz H2, 1pz H2.5
1pz H3, 2pz H4, 1pz H5, 1pz H5.5, 2pz H6
2pz T8, 2pz T9, 2pz T10, 2pz T15, 2pz T20
2pz T25, 2pz T27, 2pz T30, 2pz T40

2 giraviti doppio inserto
SL5*PH1, SL6*PH2

6 bussole 1/4"
5mm, 6mm, 7mm, 8mm, 9mm, 10mm



Specifiche tecniche

Codice INECO	Codice Total	Prezzo
4181800001	THT2506100	74.50 €

GIRAVITI

INDUSTRIAL TOTAL

Nome / Famiglia

41816

SET GIRAVITE PORTAINSERTI 6 IN 1

Descrizione

Set giravite 6 in 1 con , manico ergonomico bimatereale, in acciaio al Cr-V

Caratt.

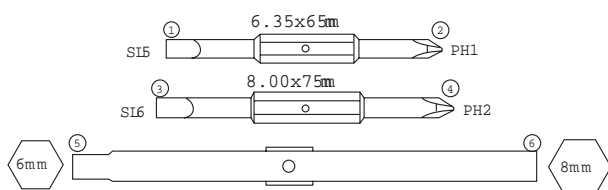

Specifiche tecniche

Codice INECO	Codice Total	Spec	Prezzo
418160001	THT2506076	2 inserti doppia impronta: 6.35x65mm, PH1+SL5 8.00x75mm, PH2+SL6	6.84 €
		2 bussole da 6mm, 8mm	
		1 manico ergonomico bimatereale	



Nome / Famiglia

41816

GIRAVITE PORTAINSERTI SNODABILE A CRICCHETTO 13 IN 1

Descrizione

Giravite a cricchetto 13 in 1 con inserti intercambiabili in acciaio al Cr-V ed impronte assortite, impugnatura bimatereale pieghevole

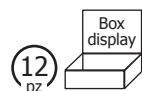

Specifiche tecniche

Codice INECO	Codice Total	Spec	Prezzo
418160002	TACSD30136	1 manico snodabile a cricchetto con serbatoio porta inserti. 12 inserti 6.35*25 mm con impronte assortite: SL4, SL5, SL6, SL7, PH0, PH1, PH2, PH3, PZ0, PZ1, PZ2, PZ3	11.05 €
		In acciaio al Cr-V, impugnatura bimatereale, in display da banco	



SL4, SL5, SL6, SL7

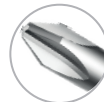

PH0, PH1, PH2, PH3

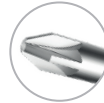

PZ0, PZ1, PZ2, PZ3



GIRAVITI

INDUSTRIAL TOTAL

Nome / Famiglia

41816

SET GIRAVITE A CRICCHETTO 15 IN 1

Descrizione

Set giravite a cricchetto 15 in 1, con manico ergonomico bimateriale, 9 inserti e 5 bussole, in acciaio al Cr-V

Caratt.



Specifiche tecniche

Codice INECO	Codice Total	Spec	Prezzo
4181600003	TACSD30156	1 manico a cricchetto 36T con impugnatura ergonomica bimateriale	19.50 €
		9 inserti 6.3X25mm con impronte assortite: SL4, SL5, SL6, PH1, PH2, PH3, PZ1, PZ2, PZ3	
		5 bussole 1/4" da 5,6,8,10 e 12mm	
		In acciaio al Cr.V.	



SL4, SL5, SL6,



PH1, PH2, PH3,



PZ1, PZ2, PZ3



Nome / Famiglia

41816

SET 9 PEZZI GIRAVITE CON LAME INTERCAMBIABILI

Descrizione

Set giravite 8 in 1 con lame intercambiabili, manico ergonomico bimateriale, in acciaio al Cr-V

Caratt.

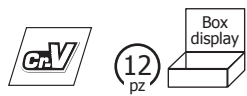

Specifiche tecniche

Codice INECO	Codice Total	Spec	Prezzo
4181600004	THT250906	3 lame per viti con intaglio SL3X65 SL5X65 SL6X65	13.30 €
		3 lame per viti con impronta Phillips™, PH0X65 PH1X65 PH2X65	
		1 rimuovi punti 5X65	
		1 punteruolo 3X65	
		1 manico intercambiabile con impugnatura ergonomica bimateriale	



SL3, SL5, SL6,



PH0, PH1, PH2



GIRAVITI

INDUSTRIAL TOTAL

Nome / Famiglia

41816

SET 24 PEZZI GIRAVITE PORTAINSERI A CRICCHETTO

Descrizione

Set 24 pezzi portainseri a cricchetto, con 16 inserti intercambiabili in acciaio al Cr-V ed impronte assortite, 7 bussole, una impugnatura ergonomica bimateriale

Caratt.

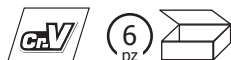

Specifiche tecniche

Codice INECO	Codice Total	Specifiche	Prezzo
4181600005	TACSD30246	16 inserti 6.35X25mm con impronte assortite: SL3,SL4,SL5,SL6,SL6,SL7 PH1,PH2,PH2,PH3 PZ1,PZ2 T10,T15,T20,T25	12.65 €
		7 bussole 1/4" da 5MM 6MM 7MM 8MM 9MM 10MM 11MM	
		1 manico a cricchetto con impugnatura ergonomica bimateriale	



SL3,SL4,SL5,SL6,SL6,SL7

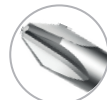

PH1,PH2,PH2,PH3



PZ1,PZ2



T10,T15,T20,T25



Nome / Famiglia

41816

SET 26 PEZZI GIRAVITE PORTAINSERI A CRICCHETTO

Descrizione

Set giravite a cricchetto 26 pezzi, con 18 inserti assortiti, 6 bussole, in acciaio al Cr-V

Caratt.



Specifiche tecniche

Codice INECO	Codice Total	Specifiche	Prezzo
4181600006	TACSD30266	1 manico portainseri a cricchetto. 18 inserti 65 mm con impronte assortite: PH0,PH1,PH2,PH3 PZ1,PZ2,PZ3, SL3,SL4,SL5,SL6,SL7 T10,T15,T20,T25,T27,T30	27.80 €
		6 bussole da 5mm,6mm, 7mm,8mm,9mm,10mm	
		In acciaio al Cr.V, in display da banco	



GIRAVITI**INDUSTRIAL TOTAL****41816****SET 33 PEZZI GIRAVITE
PORTAINSERI A CRICCHETTO**

Nome / Famiglia

Descrizione

Caratt.

Set giravite a cricchetto con impugnatura bimatériale, 33 pezzi, con 20 inserti intercambiabili assortiti, 1 porta inserti magnetico, 2 adattatori e 9 bussole, in acciaio al Cr-V



20 inserti 6.35X25mm con impronte assortite:

PH0, PH1, PH2, PH2, PH3

SL3, SL4, SL5, SL6, SL6

HEX3, HEX4, HEX5

PZ1, Z2, T10, T15, T20, T25, T30

1 adattatore per inserti 4-6mm (25mm)

9 bussole da 1/4"X20.5mm da 4mm 5mm 6mm 7mm 8mm 9mm 10mm 11mm 12mm

Specifiche tecniche

1 porta inserti magnetico da 125mm

1 porta inserti magnetico da 75mm

1 manico a cricchetto con impugnatura ergonomica bicomponente

Codice INECO	Codice Total	Prezzo
4181600007	TACSD30336	32.60 €



Nome / Famiglia

41816**SET 24 PEZZI GIRAVITE A CRICCHETTO
IMPUGNATURA A T**

Descrizione

Caratt.

Set giravite a cricchetto con impugnatura bimatériale a T, 24 pezzi, con 9 inserti intercambiabili in acciaio al Cr-V assortiti e 7 bussole



Specifiche tecniche

Codice INECO	Codice Total	Spec	Prezzo
4181600008	TACSD30186	9 inserti 6.35x25MM con impronte assortite:	11.40 €
		SL3 SL5 SL6 - PH0 PH1 PH2	
		PH3 - PZ1 PZ2 - TORX T15	
		T20 - Ex 4 5 6	
		1 porta inserti magnetico 5X100MM	
		1 manico a T con cricchetto	
		1 adattatore 4-6mm (25mm)	
		6 bussole da 1/4": 5,6,7,8,9,10 mm	



Nome / Famiglia

41816

**SET 47 PEZZI GIRAVITE
 A CRICCHETTO IMPUGNATURA A T**

Descrizione

Set giravite a cricchetto con impugnatura bimatériale a T, 47 pezzi, con 35 inserti interscambiabili assortiti

Caratt.



35Pcs 6.35X25mm inserti da
 SL3, SL4, SL5, SL6, SL7
 PH0, PH1X3, PH2X5, PH3X3
 PZ0, PZ1, PZ2X2, PZ3X2
 T10, T15, T20, T25, T27, T30, T40
 H2, H3, H4, H5, H6

9 bussole 1/4"X20.5mm da
 4, 5, 6, 7, 8, 9, 10, 11, 12 mm

1 adattatore

1 porta inserti 6.3X139mm

1 manico a cricchetto



Specifiche tecniche

Codice INECO	Codice Total	Prezzo
4181600010	TACSD30476	24.80 €

GIRAVITI**INDUSTRIAL TOTAL****41820****SET 12 PEZZI GIRAVITE PORTAINSERTI
AD ALBERO FLESSIBILE**

Nome / Famiglia

Descrizione

Caratt.

Set di giraviti con albero flessibile da 12 pezzi



1 albero flessibile con impugnatura

1 adattatore per punte 4-6mm (25mm)

10 punte da 6,35x25mm

SL5, SL6, SL7

PH1, PH2, PH3

T10, T15, T20, T25

Specifiche tecniche

Codice INECO	Codice Total	Prezzo
4182000012	THT250FL1206	8.24 €



Packaging

**41822****SET 32 PEZZI GIRAVITE
PORTAINSERTI DI PRECISIONE**

Nome / Famiglia

Descrizione

Caratt.

Set di giraviti di precisione da 32 pezzi con impugnatura ergonomica



30 punte 4x60mm

SL1.5, SL2, SL2.5, SL3, SL3.5, SL4,

PH000, PH00, PH0, PH1,

T4, T5, T6, T7, T8, T9, T10, T15, T20,

H0.9, H1.3, H1.5, H2, H2.5, H3, H4,

Y2, U2.6, Five Star0.8, Five Star1.2

1 portapunte 4x60mm

Specifiche tecniche

Codice INECO	Codice Total	Prezzo
4182200032	TACSD30326	17.55 €



GIRAVITI**INDUSTRIAL TOTAL**

Nome / Famiglia

41824**SET 55 PEZZI GIRAVITE
PORTAINSERI A CRICCHETTO**

Descrizione

Set di punte per giravite da 55 pezzi
con impugnatura ergonomica

21 punte 6,35x25mm
SL4, SL5, SL6,
PH1, PH2, PH2, PH3,
PZ1, PZ2, PZ3,
T10, T15, T20, T25, T30, T40,
H3, H4, H5, H6

20 punte di precisione 4x28mm
SL1.5, SL2, SL2.5, SL3,
PH000, PH00, PH0, PH1,
T6, T7, T8, T9, T10, T15, T20
H1.5, H2.0, H2.5, H3.0, H4.0

1 adattatore per punte 4-6mm
(25mm)

9 bussole 1/4"x20.5mm
4mm, 5mm, 6mm, 7mm, 8mm,
9mm, 10mm, 11mm, 12mm

1 portapunte 4x60mm

1 portapunte 6,35x50mm

1 cricchetto



Specifiche tecniche

Codice INECO	Codice Total	Prezzo
4182400055	TACSD30556	25.10 €

CHIAVI MASCHIO

420

**Acciaio altamente
legato** al Cromo Vanadio

Extra lunghe

Testa sferica
per un più facile
accesso alle viti
e per lavori con
un'inclinazione
fino a 25° rispetto
all'asse della vite

41804

**SERIE 9 CHIAVI
MASCHIO
ESAGONALE EXTRA
LUNGHE PIEGATE
TESTA SFERICA**

Serie 9 chiavi maschio
esagonale extra lunghe piegate
testa sferica, con supporto, in
acciaio al Cr-V

CHIAVI MASCHIO



Nome / Famiglia

42004

SERIE 9 CHIAVI MASCHIO ESAGONALE PIEGATE

Descrizione

Serie 9 chiavi maschio esagonale piegate, con supporto, in acciaio al Cr-V

Caratt.

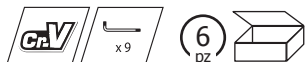

Packaging



Specifiche tecniche

Codice INECO	Codice Total	Misure	Descrizione	Prezzo
4200400001	THT106191	1.5-10	Lunghe	8.36 €

Nome / Famiglia

42004

SERIE 9 CHIAVI MASCHIO ESAGONALE EXTRA LUNGHE PIEGATE

Descrizione

Serie 9 chiavi maschio esagonale extra lunghe piegate, con supporto, in acciaio al Cr-V

Caratt.



Packaging

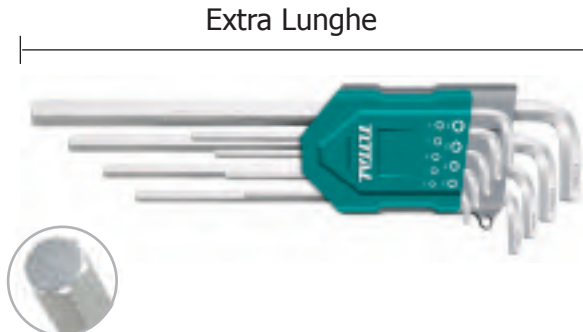

Specifiche tecniche

Codice INECO	Codice Total	Misure	Descrizione	Prezzo
4200400002	THT106192	1.5-10	Extra Lunghe	10.90 €

Nome / Famiglia

42004

SERIE 9 CHIAVI MASCHIO ESAGONALE PIEGATE TESTA SFERICA

Descrizione

Serie 9 chiavi maschio esagonale piegate testa sferica, con supporto, in acciaio al Cr-V

Caratt.



Packaging



Specifiche tecniche

Codice INECO	Codice Total	Misure	Descrizione	Prezzo
4200400003	THT106291	1.5-10	Lunghe	9.62 €

Nome / Famiglia

42004

SERIE 9 CHIAVI MASCHIO ESAGONALE EXTRA LUNGHE PIEGATE TESTA SFERICA

Descrizione

Serie 9 chiavi maschio esagonale extra lunghe piegate testa sferica, con supporto, in acciaio al Cr-V

Caratt.



Packaging



Specifiche tecniche

Codice INECO	Codice Total	Misure	Descrizione	Prezzo
4200400004	THT106292	1.5-10	Extra Lunghe	12.65 €

CHIAVI MASCHIO



42006
SERIE 9 CHIAVI MASCHIO PIEGATE PER IMPRONTA TORX™ TAMPER TORX™

Descrizione: Serie 9 chiavi maschio lunghe piegate per impronta Torx™ e Tamper Torx™ (solo lato corto), con supporto, in acciaio al Cr-V

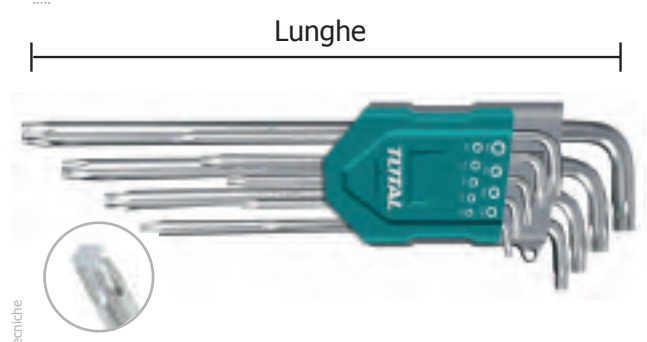

Codice INECO	Codice Total	Misure	Descrizione	Prezzo
4200600001	THT106392	T10-T50	Lunghe	9.62 €

42006
SERIE 9 CHIAVI MASCHIO EXTRA LUNGHE PIEGATE PER IMPRONTA TAMPER TORX™

Descrizione: Serie 9 chiavi maschio lunghe piegate per impronta Torx™ e Tamper Torx™ (solo lato corto), con supporto, in acciaio al Cr-V

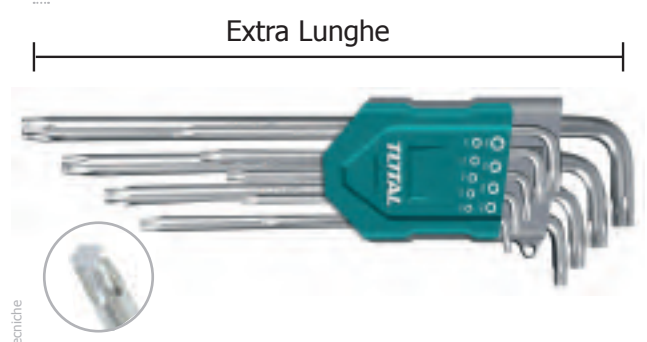
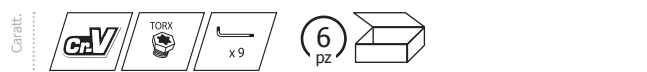

Codice INECO	Codice Total	Misure	Descrizione	Prezzo
4200600002	THT106391	T10-T50	Extra Lunghe	11.65 €

42004
SET 2 SERIE DI 9 CHIAVI MASCHIO ESAGONALE E TORX™

Descrizione: Set 2 serie di 9 chiavi maschio esagonale e Torx™, con supporto, in acciaio al Cr-V

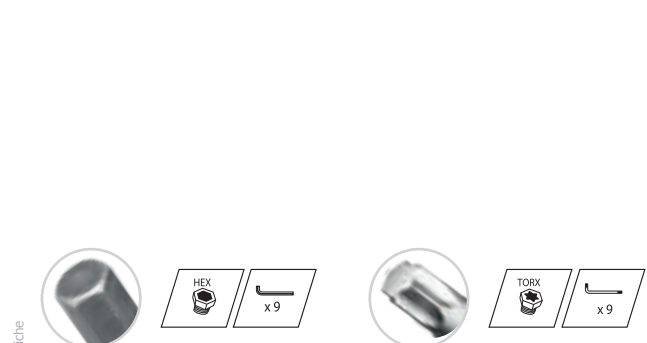

Codice INECO	Codice Total	Misure	Descrizione	Prezzo
4200400005	THT106KT0181	1,5-10	Extra Lunghe	20.30 €



CHIAVI MASCHIO



Nome / Famiglia

42008

SERIE 9 CHIAVI MASCHIO ESAGONALE PIEGATE CON SUPPORTO TASCABILE

Descrizione

Serie 9 chiavi maschio esagonale con supporto tascabile, in acciaio al Cr-V

Caratt.



Specifiche tecniche



Codice INECO	Codice Total	Misure	Prezzo
4200800001	THT1061826	2-8 mm	7.60 €

Packaging



Nome / Famiglia

42010

SERIE 9 CHIAVI MASCHIO IMPRONTA TORX™ PIEGATE CON SUPPORTO TASCABILE

Descrizione

Serie 9 chiavi maschio impronta Torx™ con supporto tascabile, in acciaio al Cr-V

Caratt.



Specifiche tecniche



Codice INECO	Codice Total	Misure	Prezzo
4201000002	THT1061846	T9-T40	8.62 €

Packaging



CHIAVI MASCHIO



Nome / Famiglia

42012

CHIAVE MASCHIO ESAGONALE PIEGATA CON IMPUGNATURA BIMATERIALE, IN ACCIAIO AL CrV

Descrizione

Chiave maschio esagonale piegata con impugnatura antiscivolo bimateriale, in acciaio al CrV, finitura cromata

Caratt.

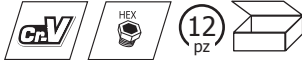

Specifiche tecniche

Codice INECO	Codice Total	Misure	Descrizione	Prezzo
4201202075	THHW1520751	2x75	ESAGONALE	1.28 €
4201225075	THHW1525751	2,5x75	ESAGONALE	1.40 €
4201203100	THHW1531001	3x100	ESAGONALE	1.52 €
4201204100	THHW1541001	4x100	ESAGONALE	2.54 €
4201205150	THHW1551501	5x150	ESAGONALE	2.80 €
4201206150	THHW1561501	6x150	ESAGONALE	3.18 €
4201208200	THHW1582001	8x200	ESAGONALE	4.44 €
4201210200	THHW15102001	10x200	ESAGONALE	6.34 €

CHIAVI MASCHIO



42014

CHIAVE MASCHIO PIEGATA CON IMPUGNATURA PER VITI CON IMPRONTA TORX™

Descrizione: Chiave maschio piegata con impugnatura bimatériale per viti con impronta TORX®, in acciaio al CrV, finitura cromata

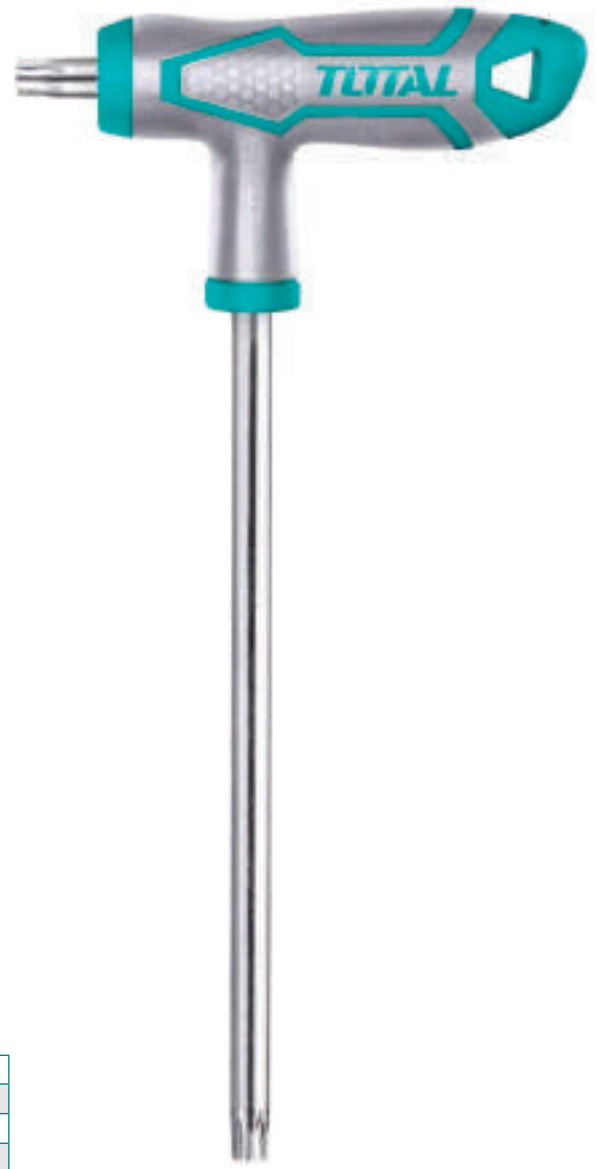

Specifiche tecniche

Codice INECO	Codice Total	Misure	Descrizione	Prezzo
4201400009	THHW15T90751	T9X75	TORX®	1.66 €
4201400010	THHW15T100751	T10x75	TORX®	1.78 €
4201400015	THHW15T150751	T15X75	TORX®	1.90 €
4201400020	THHW15T201001	T20x100	TORX®	2.04 €
4201400025	THHW15T251001	T25x100	TORX®	2.80 €
4201400027	THHW15T271501	T27X150	TORX®	3.04 €
4201400030	THHW15T301501	T30x150	TORX®	3.30 €
4201400040	THHW15T401501	T40X150	TORX®	3.80 €
4201400045	THHW15T452001	T45X200	TORX®	4.56 €
4201400050	THHW15T502001	T50X200	TORX®	5.82 €

CHIAVI MASCHIO



Nome / Famiglia

42016
SET 8 CHIAVI MASCHIO ESAGONALI PIEGATE CON IMPUGNATURA

Descrizione

Set 8 chiavi maschio esagonali piegate con impugnatura bimatériale antiscivolo, in acciaio al CrV

Caratt.

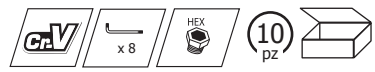

Specifiche tecniche

Codice INECO	Codice Total	Misure	Descrizione	Prezzo
420160008	THHW8081	2X75-2.5X75-3X100-4X100-5X150-6X150-8X200-10X200	esagonali	20.30 €

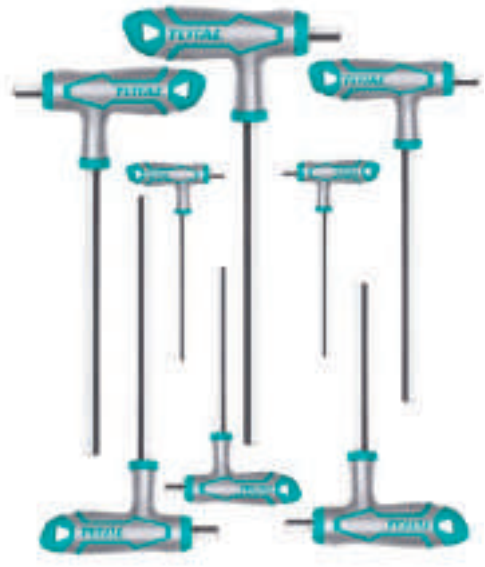

Packaging



Nome / Famiglia

42018
SET 8 CHIAVI MASCHIO PIEGATE CON IMPUGNATURA PER VITI CON IMPRONTA TORX™

Descrizione

Set 8 chiavi maschio piegate con impugnatura bimatériale antiscivolo, per viti con impronta TORX®, in acciaio al CrV

Caratt.

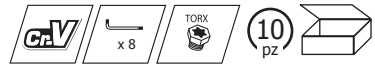

Specifiche tecniche

Codice INECO	Codice Total	Misure	Descrizione	Prezzo
420180008	THHW8083	T10X75-T15X75-T20X100-T25X100-T30X150-T40X150-T45X200-T50X200	TORX®	21.60 €



Packaging



TOTAL
INDUSTRIAL



CHIAVI DI MANOVRA

422

Supporto con maniglia
per un pratico trasporto
e conservazione



**Testa in acciaio
altamente
legato al Cromo
Molibdeno**

42208

**SET 8 CHIAVI
COMBinate
A CRICCHETTO CON
SUPPORTO**

Set 8 chiavi combinate a
cricchetto con supporto,
finitura lucida, in acciaio al Cr-V

CHIAVI DI MANOVRA



Nome / Famiglia

42201

CHIAVE COMBINATA

Descrizione

Chiave combinata in acciaio al Cr-V finitura opaca



Specifiche tecniche

Codice INECO	Codice Total	Dimensione	Prezzo
422010006	TCSPA061	6 mm	1.78 €
422010007	TCSPA071	7 mm	1.78 €
422010008	TCSPA081	8 mm	1.90 €
422010009	TCSPA091	9 mm	2.04 €
422010010	TCSPA101	10 mm	2.28 €
422010011	TCSPA111	11 mm	2.48 €
422010012	TCSPA121	12 mm	2.60 €
422010013	TCSPA131	13 mm	2.80 €
422010014	TCSPA141	14 mm	2.86 €
422010015	TCSPA151	15 mm	3.10 €
422010016	TCSPA161	16 mm	3.48 €
422010017	TCSPA171	17 mm	3.62 €
422010018	TCSPA181	18 mm	3.94 €
422010019	TCSPA191	19 mm	4.18 €
422010020	TCSPA201	20 mm	4.70 €
422010021	TCSPA211	21 mm	5.06 €
422010022	TCSPA221	22 mm	5.38 €
422010023	TCSPA231	23 mm	6.78 €
422010024	TCSPA241	24 mm	7.34 €
422010025	TCSPA251	25 mm	9.12 €
422010026	TCSPA261	26 mm	9.76 €
422010027	TCSPA271	27 mm	10.15 €
422010028	TCSPA281	28 mm	9.94 €
422010029	TCSPA291	29 mm	10.40 €
422010030	TCSPA301	30 mm	12.60 €
422010032	TCSPA321	32 mm	14.05 €
422010036	TCSPA361	36 mm	22.40 €



CHIAVI DI MANOVRA



42207

CHIAVE COMBINATA A CRICCHETTO

Nome / Famiglia

Descrizione

Chiave combinata a cricchetto in acciaio al Cr-V, con testa in acciaio altamente legato al cromo molibdeno



Specifiche tecniche

Codice INECO	Codice Total	Dimensione	Prezzo
4220700006	TCSPAR061	6 mm	5.06 €
4220700007	TCSPAR071	7 mm	5.06 €
4220700008	TCSPAR081	8 mm	5.06 €
4220700009	TCSPAR091	9 mm	5.70 €
4220700010	TCSPAR101	10 mm	5.96 €
4220700011	TCSPAR111	11 mm	6.08 €
4220700012	TCSPAR121	12 mm	6.66 €
4220700013	TCSPAR131	13 mm	7.10 €
4220700014	TCSPAR141	14 mm	7.54 €
4220700015	TCSPAR151	15 mm	8.10 €
4220700016	TCSPAR161	16 mm	8.24 €
4220700017	TCSPAR171	17 mm	8.48 €
4220700018	TCSPAR181	18 mm	8.80 €
4220700019	TCSPAR191	19 mm	9.62 €
4220700021	TCSPAR211	21 mm	12.65 €
4220700022	TCSPAR221	22 mm	13.50 €
4220700024	TCSPAR241	24 mm	16.10 €

CHIAVI DI MANOVRA

INDUSTRIAL TOTAL

Nome / Famiglia

42202

SET 8 CHIAVI COMBinate CON SUPPORTO

Descrizione

Set 8 chiavi combinate con supporto finitura lucida in acciaio al Cr-V



Specifiche tecniche

Misure:

6mm,8mm,10mm,13mm,14mm,15mm,17mm,19mm

Codice INECO	Codice Total	Misure	N	Prezzo
4220261908	THT102286-I	6-19	8	19.90 €



Nome / Famiglia

42204

SET 8 CHIAVI A FORCHETTA DOPPIE CON SUPPORTO

Descrizione

Set 8 chiavi a forchetta doppie con supporto finitura lucida in acciaio al Cr-V



Specifiche tecniche

Codice INECO	Codice Total	Misure	N	Prezzo
4220462208	THT102386	6-22	8	21.40 €



Nome / Famiglia

42206

SET 8 CHIAVI POLIGONALI DOPPIE CURVE CON SUPPORTO

Descrizione

Set 8 chiavi poligonali doppie curve con supporto finitura lucida in acciaio al Cr-V



Specifiche tecniche

Codice INECO	Codice Total	Misure	N	Prezzo
4220662208	THT102486	6-22	8	27.60 €



CHIAVI DI MANOVRA

INDUSTRIAL TOTAL

Nome / Famiglia

42208

SET 8 CHIAVI COMBinate A CRICCHETTO CON SUPPORTO

Descrizione

Set 8 chiavi combinate a cricchetto con supporto, finitura lucida, in acciaio al Cr-V



Specifiche tecniche

Codice INECO	Codice Total	Misure	Prezzo
4220881908	THT102RK086	8-19	59.50 €



Nome / Famiglia

42209

SET 8 CHIAVI COMBinate A CRICCHETTO CON SNODO

Descrizione

Set 8 chiavi combinate a cricchetto con snodo, con cricchetto in acciaio CrMo, finitura lucida



Specifiche tecniche

Codice INECO	Codice Total	Misure	N	Prezzo
4220900008	THT102RK586	8-19	8	63.50 €



CHIAVI DI MANOVRA

INDUSTRIAL TOTAL
42210

SET 12 CHIAVI COMBinate 6-24 MM IN BUSTA

Nome / Famiglia

Descrizione

Set 12 chiavi combinate su telo, misure da 6 a 24 mm, finitura lucida, in acciaio al Cr-V

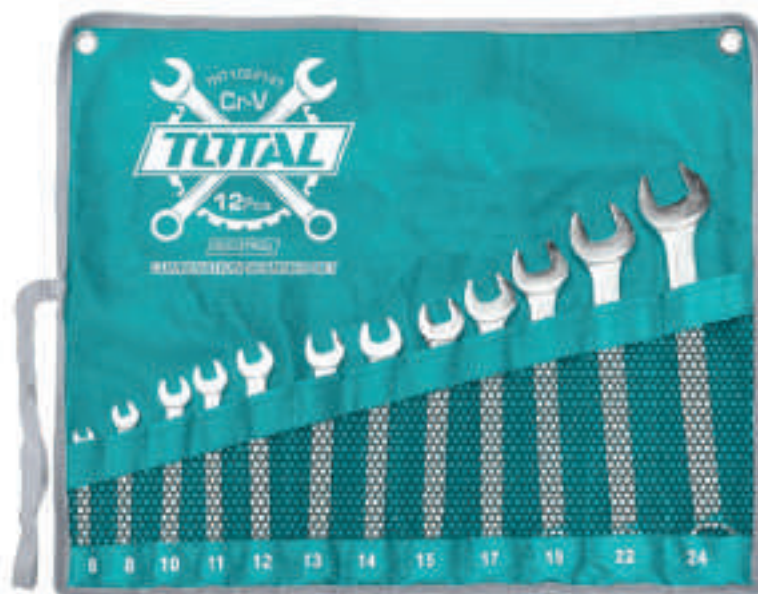

Misure:

6mm, 8mm, 10mm, 11mm, 12mm, 13mm, 14mm,
15mm, 17mm, 19mm, 22mm, 24mm

Specifiche tecniche

In acciaio al Cr-V, finitura lucida

Codice INECO	Codice Total	Misure	N	Prezzo
4221062412	THT1022121	6-24	12	40.50 €

42210

SET 15 CHIAVI COMBinate 6-32 MM IN BUSTA

Nome / Famiglia

Descrizione

Set 15 chiavi combinate su telo, misure da 6 a 32 mm, finitura lucida, in acciaio al Cr-V



Misure:

6mm, 8mm, 10mm, 13mm, 14mm, 15mm,
17mm, 19mm, 21mm, 23mm, 24mm, 27mm,
29mm, 30mm, 32mm

Specifiche tecniche

Codice INECO	Codice Total	Misure	N	Prezzo
4221063215	THT1022152B	6-32	15	82.00 €

CHIAVI DI MANOVRA



42212

Nome / Famiglia

SET 12 CHIAVI FORCHETTA DOPPIA IN BUSTA

Descrizione

Set 12 chiavi forchetta doppia, su telo, finitura lucida, in acciaio al Cr-V



Specifiche tecniche

Codice INECO	Codice Total	Misure	N	Prezzo
4221263212	THT1023121	6-32	12	58.50 €

42214

Nome / Famiglia

SET 12 CHIAVI POLIGONALI DOPPIE CURVE IN BUSTA

Descrizione

Set 12 chiavi poligonali doppie curve, su telo, finitura lucida, in acciaio al Cr-V



Specifiche tecniche

Codice INECO	Codice Total	Misure	N	Prezzo
4221463212	THT1024121	6-32	12	75.00 €

42216

Nome / Famiglia

SET 6 CHIAVI COMBinate A CRICCHETTO IN BUSTA

Descrizione

Set 6 chiavi combinate a cricchetto su telo, finitura lucida, in acciaio al Cr-V



Specifiche tecniche

Codice INECO	Codice Total	Misure (mm)	Prezzo
4221619326	THT102RK061	19-32	116.50 €

42218

Nome / Famiglia

CHIAVE REGOLABILE A RULLINO

Descrizione

Chiave regolabile a rullino, con manico ergonomico bimatereale, in acciaio al Cr-V

Caratt.

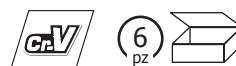

Packaging



Specifiche tecniche

Codice INECO	Codice Total	L(mm)	Misure	Prezzo
4221800150	THT101066	150(6")	24	8.86 €
4221800200	THT101086	200(8")	30	12.65 €
4221800250	THT101106	250(10")	35	17.00 €
4221800300	THT101126	300(12")	41	23.50 €

CHIAVI DI MANOVRA



Nome / Famiglia

42220

CHIAVI AUTOSERRANTI A RIPRESA AUTOMATICA

Descrizione

Chiavi autoserranti a ripresa automatica con impugnatura ergonomica bimateriale

Caratt.



Packaging



Specifiche tecniche



Codice INECO	Codice Total	Misure	Prezzo
4222000001	THT10309328	9-14, 15-22, 23-32	16.70 €

Nome / Famiglia

42222

SET 9 PEZZI DI CHIAVI A PIPA A PIPA

Descrizione

Set 9 pezzi di chiavi a pipa doppie esagonali in acciaio al Cr-V con supporto



Specifiche tecniche



Codice INECO	Codice Total	Pz	Misure	Prezzo
4222271909	TLASWT0901	9	7, 8, 10, 11, 12, 13 14, 17, 19	57.50 €

CHIAVI A BUSSOLA

424

Impugnatura
ergonomica

Valigetta in
ABS
ad alta
resistenza

44 utensili

Solidi ganci di chiusura



42408

**ASSORTIMENTO 44 PEZZI
BUSSOLE 1/2" 1/4"
E ACCESSORI**

Assortimento 44 pezzi bussole 1/2"+1/4" ed accessori, cricchetti reversibili in acciaio al Cr-V con impugnatura ergonomica bimatereale, in valigetta ABS ad alta resistenza

CHIAVI A BUSSOLA



Nome / Famiglia

42404

CHIAVE A BUSSOLA DA 1/2 CON BOCCA ESAGONALE

Descrizione

Chiave a bussola da 1/2 con bocca esagonale, in acciaio al CrV, finitura nichelata nera

Caratt.



Packaging



Specifiche tecniche

Codice INECO	Codice Total	D (mm)		Prezzo
4240400008	THTST12081	8	10	2.42 €
4240400009	THTST12091	9	10	2.42 €
4240400010	THTST12101	10	10	2.42 €
4240400011	THTST12111	11	10	2.42 €
4240400012	THTST12121	12	10	2.42 €
4240400013	THTST12131	13	10	2.42 €
4240400014	THTST12141	14	10	2.66 €
4240400015	THTST12151	15	10	2.66 €
4240400016	THTST12161	16	10	2.66 €
4240400017	THTST12171	17	10	3.04 €
4240400018	THTST12181	18	8	3.04 €
4240400019	THTST12191	19	8	3.04 €

Codice INECO	Codice Total	D (mm)		Prezzo
4240400020	THTST12201	20	8	3.30 €
4240400021	THTST12211	21	8	3.30 €
4240400022	THTST12221	22	8	4.06 €
4240400023	THTST12231	23	6	4.06 €
4240400024	THTST12241	24	6	4.06 €
4240400025	THTST12251	25	5	4.94 €
4240400026	THTST12261	26	5	4.94 €
4240400027	THTST12271	27	5	4.94 €
4240400028	THTST12281	28	4	6.34 €
4240400029	THTST12291	29	4	6.34 €
4240400030	THTST12301	30	4	6.96 €
4240400032	THTST12321	32	4	7.60 €

Nome / Famiglia

42405

CHIAVE A BUSSOLA LUNGA DA 1/2 CON BOCCA ESAGONALE

Descrizione

Chiave a bussola lunga da 1/2 con bocca esagonale, in acciaio al CrV, finitura nichelata nera

Caratt.



Packaging



Specifiche tecniche

Codice INECO	Codice Total	D (mm)		Prezzo
4240500010	THTST12103L	10	6	4.70 €
4240500011	THTST12113L	11	6	4.70 €
4240500012	THTST12123L	12	6	4.70 €
4240500013	THTST12133L	13	6	4.70 €
4240500014	THTST12143L	14	6	4.70 €
4240500015	THTST12153L	15	6	4.70 €
4240500016	THTST12163L	16	6	4.70 €
4240500017	THTST12173L	17	6	4.70 €

Codice INECO	Codice Total	D (mm)		Prezzo
4240500018	THTST12183L	18	5	5.06 €
4240500019	THTST12193L	19	5	5.06 €
4240500021	THTST12213L	21	5	5.70 €
4240500022	THTST12223L	22	4	5.70 €
4240500024	THTST12243L	24	4	6.96 €
4240500027	THTST12273L	27	2	8.24 €
4240500030	THTST12303L	30	2	10.15 €
4240500032	THTST12323L	32	2	11.40 €

CHIAVI A BUSSOLA



Nome / Famiglia

42402

CRICCHETTI REVERSIBILI

Descrizione

Cricchetti reversibili, con meccanismo a 45 denti, impugnatura ergonomica bimatériale, in acciaio al Cr-V + Cr-Mo

Caratt.



Packaging



Specifiche tecniche

Codice INECO	Codice Total	Denti	Misura	Prezzo
4240200014	THT106146	45	1/4"	10.65 €
4240200038	THT106386	45	3/8"	14.20 €
4240200012	THT106126	45	1/2"	19.00 €

Nome / Famiglia

42411

SET 3 BUSSOLE PER CERCHI IN LEGA

Descrizione

Set di 3 bussole da 1/2" per cerchi in lega con copertura antigraffio, in acciaio al Cromo-Molibdeno, dimensioni 17,19,21 mm, con guaina in nylon



Specifiche tecniche

Codice INECO	Codice Total	Misura	Prezzo
424112003	THMLNS031	1/2"	30.50 €

Nome / Famiglia

42403

CRICCHETTO CON ATTACCO DOPPIO 1/4" E 3/8"

Descrizione

Cricchetto con doppio attacco da 1/4" e 3/8", 72 denti, in acciaio al Cr-V e Cr-Mo

Caratt.

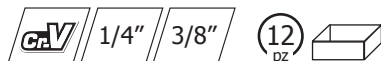

Specifiche tecniche

Codice INECO	Codice Total	Denti	Misura	Lunghezza	Prezzo
4240300140	THT1061438	72	1/4" e 3/8"	140	15.60 €

CHIAVI A BUSSOLA



Nome / Famiglia

42408

ASSORTIMENTO 12 PEZZI BUSSOLE 1/2" E ACCESSORI

Descrizione

Assortimento 12 pezzi bussole 1/2", cricchetto con impugnatura ergonomica bimateriale a 72 denti, 10 bussole ed 1 prolunga, in acciaio al Cr-V

Caratt.

DIN 3122 DIN 3123 DIN 3124 1/2" Cr-V 50BV30 5 pz

Specifiche tecniche



Codice INECO	Codice Total	Pezzi	Prezzo
4240812012	THT141121	12	41.80 €



Nome / Famiglia

42408

ASSORTIMENTO 12 PEZZI BUSSOLE 1/4" E ACCESSORI

Descrizione

Set di 12 chiavi a bussola da 1/4", in acciaio al Cromo-Vanadio con rivestimento cromato

Caratt.

DIN 3122 DIN 3123 DIN 3124 1/4" Cr-V 50BV30 5 pz

- 10 bussole da 1/4"
5, 6, 7, 8, 9, 10, 11, 12, 13, 14 mm
- 1 cricchetto da 1/4" 45T a sgancio rapido
- 1 barra di estensione 1/4" da 100mm

Specifiche tecniche



Codice INECO	Codice Total	Misura	Prezzo
4240814012	THT14114126	1/4"	23.80 €



CHIAVI A BUSSOLA



Nome / Famiglia

42406
CHIAVE A CROCE
REGOLABILE

Descrizione

Chiave a croce regolabile, con impugnatura ergonomica bimatériale

Caratt.

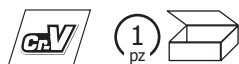

Specifiche tecniche



Codice INECO	Codice Total	Misura	Prezzo
4240600001	THTRCW40231	17x19x21x23	38.00 €

Nome / Famiglia

42407
BUSSOLA 1/2 PER
CANDELE

Descrizione

Bussola attacco 1/2 per candele 16 mm e 21 mm, in acciaio CrV, finitura lucida

Packaging



Specifiche tecniche



Codice INECO	Codice Total	D (mm)	Icona	Prezzo
4240700016	THSPS12166	16	6	3.56 €
4240700021	THSPS12216	21	5	4.44 €

Nome / Famiglia

42409
SNODO DA 1/2

Descrizione

Snodo con attacco da 1/2, in acciaio al CrV, finitura cromata

Caratt.

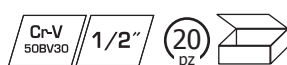

Specifiche tecniche



Codice INECO	Codice Total	D (mm)	Prezzo
4240900012	THHUI1121	1/2	7.34 €

Nome / Famiglia

42409
PROLUNGA
ATTACCO DA 1/2

Descrizione

Prolunga con attacco da 1/2, in acciaio al CrV, finitura cromata

Caratt.

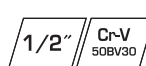

Specifiche tecniche



Codice INECO	Codice Total	D (mm)	L (mm)	Icona	Prezzo
4240900127	THEB12051	1/2	127	20	5.58 €
4240900254	THEB12101	1/2	254	10	9.50 €

CHIAVI A BUSSOLA



Nome / Famiglia

42409

PROLUNGA DI FORZA ATTACCO 1/2

Descrizione

Prolunga di forza attacco 1/2, massima forza applicabile 300 Nm, in acciaio CrV



Specifiche tecniche

Codice INECO	Codice Total	Prezzo
424090005	THPTW300N2	19.00 €

Nome / Famiglia

42409

QUADRO MASCHIO 1/2 CON SPINA SCORREVOLE

Descrizione

Quadro maschio 1/2 con spina scorrevole, in acciaio Crv, finitura lucida



10" (250mm)

Specifiche tecniche

Codice INECO	Codice Total	Dim (mm)	Prezzo
4240912250	THSTB12106	250 mm	7.60 €

Nome / Famiglia

42409

QUADRO MASCHIO 1/2 SNODATO CON IMPUGNATURA IN METALLO

Descrizione

Quadro maschio 1/2 snodato, in acciaio Crv, finitura lucida



15" (375mm)

Specifiche tecniche

Codice INECO	Codice Total	Dim (mm)	Prezzo
4240912375	THTFX12151	375 mm	17.75 €

Nome / Famiglia

42409

QUADRO MASCHIO 1/2 CON IMPUGNATURA IN METALLO CURVA

Descrizione

Quadro maschio 1/2 con impugnatura in metallo curva



12" (300mm)

Specifiche tecniche

Codice INECO	Codice Total	Dim (mm)	Prezzo
4240912300	THLHD12121	300 mm	8.86 €

CHIAVI A BUSSOLA



42408

ASSORTIMENTO 45 PEZZI BUSSOLE 1/4" E ACCESSORI

Nome / Famiglia

Descrizione
Assortimento 45 pezzi bussole 1/4" ed accessori, cricchetto reversibile in acciaio al Cr-V con impugnatura ergonomica bimateriale, in valigetta ABS ad alta resistenza

Caratt.

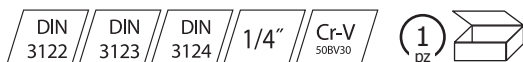

Specifiche tecniche

Codice INECO	Codice Total	Pezzi	Prezzo
4240814045	THT141451	45	55.00 €



42408

ASSORTIMENTO 25 PEZZI BUSSOLE 1/2" E ACCESSORI

Nome / Famiglia

Descrizione
Assortimento 25 pezzi bussole 1/2" ed accessori, cricchetto reversibile in acciaio al Cr-V con impugnatura ergonomica bimateriale, in valigetta ABS ad alta resistenza

Caratt.

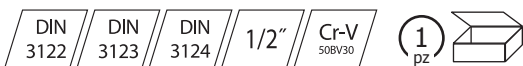

- 1 cricchetto da 1/2", 45T, con impugnatura bimateriale
- 18 bussole da 1/2": 10-11-12-13-14-15-16-17-18-19-20-21-22-23-24-27-30-32mm
- 1 snodo 1/2"
- 2 prolunghe 1/2": 125mm & 250mm
- 2 bussole per candele: 16mm & 21mm
- 1 prolunga a T da 1/2"x250mm

In acciaio al Cr-V.



Specifiche tecniche

Codice INECO	Codice Total	Pezzi	Prezzo
4240812025	THT121251	25	112.00 €



CHIAVI A BUSSOLA



42408

ASSORTIMENTO 44 PEZZI BUSSOLE 1/2" 1/4" E ACCESSORI

Assortimento 44 pezzi bussole 1/2"+1/4" ed accessori, cricchetti reversibili in acciaio al Cr-V con impugnatura ergonomica bimatereale, in valigetta ABS ad alta resistenza

Caratt. DIN 3122 DIN 3123 DIN 3124 1/4" 1/2" Cr-V 50BV30 1 pz



Codice INECO	Codice Total	Pezzi	Prezzo
42408121444	THT421441	44	145.00 €



TOTAL

One-Stop Tools Station

MARTELLI E SCALPELLI

426

Testa in **acciaio
forgiato** temprato

Manico in fibra
di vetro con
impugnatura
**ergonomica
bimateriale**

42602

**MARTELLO TIPO
TEDESCO PER
MECCANICI**

Martello tipo tedesco per
meccanici, manico bimateriale
in fibra di vetro



MARTELLI E SCALPELLI



42602

MARTELLO TIPO TEDESCO PER MECCANICI

Nome / Famiglia

Descrizione

Martello tipo tedesco per meccanici, manico bimerale in fibra di vetro



Specifiche tecniche

Codice INECO	Codice Total	Peso (gr)	Prezzo
4260200100	THTS71100	100	4.70 €
4260200200	THT712006	200	5.06 €
4260200300	THT713006	300	6.34 €
4260200500	THT715006	500	7.60 €
4260201000	THT7110006	1000	12.65 €
4260201500	THT7115006	1500	16.45 €
4260202000	THT7120006	2000	20.30 €

42604

MAZZETTA PER MURATORI

Nome / Famiglia

Descrizione

Mazzetta con manico bimerale in fibra di vetro



1000gr-1500gr



2000gr



Specifiche tecniche

Codice INECO	Codice Total	Peso (gr)	Prezzo
4260401000	THT7210006	1000	12.05 €
4260401500	THT7215006	1500	15.85 €
4260402000	THT7220006	2000	18.35 €

42606

MARTELLO AMERICANO PENNA A GRANCHIO

Nome / Famiglia

Descrizione

Martello americano penna a granchio, manico forgiato rivestito in gomma bimerale



A



Specifiche tecniche

Codice INECO	Codice Total	Peso (gr)	Tipo	Prezzo
4260600220	THTS7308	220	A	7.98 €
4260610450	THT73166	450	A	10.50 €

42608

MARTELLO TESTA TONDA E PENNA SFERICA

Nome / Famiglia

Descrizione

Martello testa tonda e penna sferica, manico bimerale in fibra di vetro



Specifiche tecniche

Codice INECO	Codice Total	Peso (gr)	Prezzo
4260800450	THT74166	450	9.62 €

MARTELLI E SCALPELLI



42612

MAZZUOLA TESTA NYLON E GOMMA

Nome / Famiglia

Descrizione

Mazzuola testa nylon e gomma, manico in fibra di vetro



Specifiche tecniche

Codice INECO	Codice Total	Misure (mm)	Prezzo
4261200040	THT77406	40mm(1-9/16")	13.70 €

42614

MAZZUOLA IN GOMMA NERA

Nome / Famiglia

Descrizione

Mazzuola testa cilindrica in gomma nera, manico i fibra di vetro

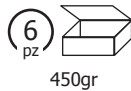
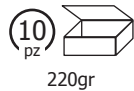

Specifiche tecniche

Codice INECO	Codice Total	Peso (gr)	Prezzo
4261410220	THT76816	220	5.96 €
4261410450	THT761616	450	7.72 €

42614

MAZZUOLA IN GOMMA BIANCA

Nome / Famiglia

Descrizione

Mazzuola testa cilindrica in gomma bianca, manico i fibra di vetro

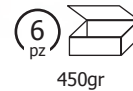
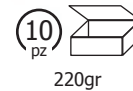

Specifiche tecniche

Codice INECO	Codice Total	Peso (gr)	Prezzo
4261420220	THT76836	220	8.10 €
4261420450	THT761636	450	11.40 €

MARTELLI E SCALPELLI



Nome / Famiglia

42616
MAZZA

Descrizione

Mazza manico bimateriale in fibra di vetro

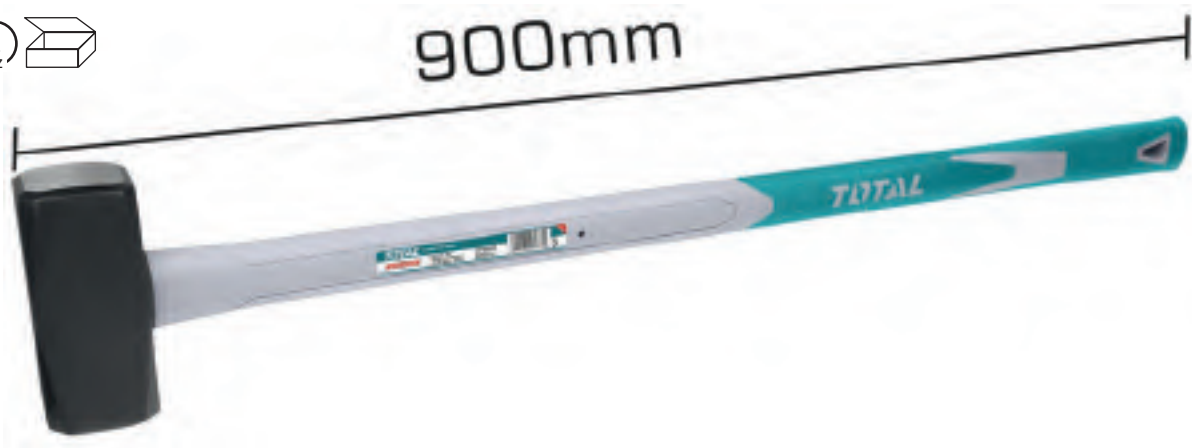

Specifiche tecniche

Codice INECO	Codice Total	Peso (kg)	L	Prezzo
4261604000	THT720416	4	900	50.00 €
4261605000	THT720516	5	900	56.50 €

Nome / Famiglia

42628
MARTELLINO ANTIRIMBALZO

Descrizione

Martello anti-rimbalzo, 900g, impugnatura ergonomica in fibra di vetro

Caratt.



Specifiche tecniche

Codice INECO	Codice Total	Peso (g)	Prezzo
4262800001	THT79021	900	18.10 €

MARTELLI E SCALPELLI



42618

SCALPELLO PER LEGNO

Nome / Famiglia

Descrizione

Scalpello per legno con impugnatura ergonomica bimateriale, in acciaio al Cr-V

Caratt.

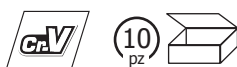

Packaging



Specifiche tecniche

Codice INECO	Codice Total	Lar(mm)	Lun(mm)	Prezzo
4261806140	THT4166	6	140	6.08 €
4261812140	THT41126	12	140	6.58 €
4261819140	THT41196	19	140	6.96 €
4261825140	THT41256	25	140	7.60 €

42620

SET 4 SCALPELLI PER LEGNO

Nome / Famiglia

Descrizione

Set 4 scalpelli per legno con impugnature ergonomiche bimateriale, in acciaio al Cr-V

Caratt.

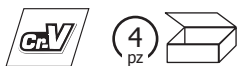

Specifiche tecniche

Codice INECO	Codice Total	Lar(mm)	Lun(mm)	Prezzo
4262000001	THT41K0401	6, 12, 19, 25	140	25.30 €

MARTELLI E SCALPELLI



Nome / Famiglia

42622
SCALPELLO PIATTO CON PARAMANO

Descrizione

Scalpello in acciaio temprato con paramano in gomma

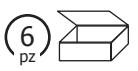

Packaging



Specifiche tecniche

Codice INECO	Codice Total	Misure (mm)	Prezzo
4262200250	THT4211026	22x16x250	5.96 €
4262200300	THT4211226	24x18x300	7.34 €

Nome / Famiglia

42624
SCALPELLO A PUNTA CON PARAMANO

Descrizione

Punta in acciaio temprato con paramano in gomma



Packaging



Specifiche tecniche

Codice INECO	Codice Total	Misure (mm)	Prezzo
4262400250	THT4221026	4x16x250	5.96 €
4262400300	THT4221226	4x18x300	7.34 €

Nome / Famiglia

42626
LEVA PER CARPENTIERI

Descrizione

Leva per carpentieri a sezione ovale



A



Specifiche tecniche

Codice INECO	Codice Total	A(mm)	B (mm)	C (mm)	Prezzo
4262600350	THT431142	350(14")	22(7/8")	12(1/2")	10.15 €
4262600600	THT431242	600(24")	29(1-1/8")	15(19/32")	24.10 €
4262600900	THT431362	900(36")	29(1-1/8")	15(19/32")	34.70 €

UTENSILI DA TAGLIO

428

Impugnatura ergonomica
bimateriale per una presa confortevole e sicura

3 lame in acciaio
alta qualità SK5
incluse

Porta lame in metallo ad alta resistenza adatto anche per i lavori più gravosi

42816

**CUTTER
CON 3 LAME**

Cutter per lame a settori con corpo in materiale sintetico e portalama in acciaio. Dotato di impugnatura ergonomica antiscivolo, serbatoio lame e pulsante di blocco automatico della lama

UTENSILI DA TAGLIO

INDUSTRIAL TOTAL

Nome / Famiglia

42802

TENAGLIA PER CEMENTISTI

Descrizione

Tenaglia per cementisti, impugnatura antiscivolo, finitura nera e lucida

Caratt.



6 pz



Packaging



Specifiche tecniche

Codice INECO	Codice Total	L(mm)	Prezzo
4280200200	THT2881	200(8")	7.60 €
4280200228	THT2891	228(9")	7.98 €
4280200250	THT28101	250(10")	8.86 €

Nome / Famiglia

42804

TENAGLIA PER FALEGNAMI

Descrizione

Tenaglia per falegnami, impugnatura antiscivolo, finitura nera e lucida

Caratt.



6 pz



Packaging



Specifiche tecniche

Codice INECO	Codice Total	L(mm)	Prezzo
4280400200	THT290801	200(8")	8.62 €

Nome / Famiglia

42806

TRONCABULLONI

Descrizione

Troncabulloni con impugnatura ergonomica bimateriale, taglienti in Cr-V

1 pz



Specifiche tecniche

Codice INECO	Codice Total	L(mm)	Ø(mm)	Prezzo
4280600200	THT11386	200	5	9.10 €
4280600355	THT113146	350	6	22.80 €
4280600450	THT113186	450	8	26.60 €
4280600600	THT113246	600	10	36.70 €
4280600750	THT113306	750	13	54.50 €
4280600900	THT113366	900	16	68.50 €

Nome / Famiglia

42808

CESOIE PER LAMIERA

Descrizione

Cesoie per lamiera con manico antiscivolo

6 pz



Packaging



Specifiche tecniche

Codice INECO	Codice Total	L(mm)	Prezzo
4280800250	THT524101	250	12.65 €

UTENSILI DA TAGLIO



Nome / Famiglia

42810
CESOIE A DOPPIA LEVA PER LAMIERE - LAME SINISTRORSE

Descrizione

Cesoie a doppia leva per il taglio di lamiera, esecuzione con lame sinistrorse, impugnatura ergonomica bimatériale

Packaging

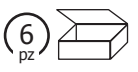

Specifiche tecniche

Codice INECO	Codice Total	L(mm)	Prezzo
4281010250	THT521106	250(10")	11.05 €

Nome / Famiglia

42810
CESOIE A DOPPIA LEVA PER LAMIERE - LAME DIRITTE

Descrizione

Cesoie a doppia leva per il taglio di lamiera, esecuzione con lame diritte, impugnatura ergonomica bimatériale

Packaging

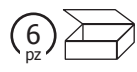

Specifiche tecniche

Codice INECO	Codice Total	L(mm)	Prezzo
4281020250	THT522106	250(10")	11.05 €

Nome / Famiglia

42810
CESOIE A DOPPIA LEVA PER LAMIERE - LAME DESTRORE

Descrizione

Cesoie a doppia leva per il taglio di lamiera, esecuzione con lame destrorse, impugnatura ergonomica bimatériale

Packaging

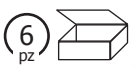

Specifiche tecniche

Codice INECO	Codice Total	L(mm)	Prezzo
4281030250	THT523106	250(10")	11.05 €

Nome / Famiglia

42812
CESOIE PER PLASTICA E GOMMA

Descrizione

Cesoie a doppia leva per il taglio di plastica e gomma, impugnatura ergonomica bimatériale



Specifiche tecniche

Codice INECO	Codice Total	L(mm)	Prezzo
4281240250	THT525106	300(12")	15.20 €

UTENSILI DA TAGLIO



42830

FORBICE

Nome / Famiglia

Descrizione

Forbice in acciaio con impugnatura bimateriale antiscivolo



Packaging



Specifiche tecniche

Codice INECO	Codice Total	Dim (mm)	Prezzo
4283000001	THSCRS812001	215	3.80 €
4283000002	THSCRS812801	275	5.08 €

42816

CUTTER CON LAMA A SETTORI

Nome / Famiglia

Descrizione

Cutter per lame a settori con corpo in materiale sintetico e portalama in acciaio. Dotato di impugnatura ergonomica antiscivolo e pulsante di blocco automatico della lama

Caratt.



Packaging

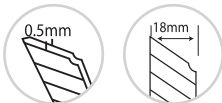

Specifiche tecniche

Codice INECO	Codice Total	L(mm)	Lar. (mm)	Prezzo
4281610018	THT511815	100	18	2.48 €

42816

CUTTER CON 3 LAME

Nome / Famiglia

Descrizione

Cutter per lame a settori con corpo in materiale sintetico e portalama in acciaio. Dotato di impugnatura ergonomica antiscivolo, serbatoio lame e pulsante di blocco automatico della lama

Caratt.

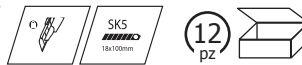

Packaging

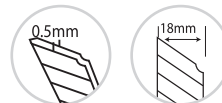

Specifiche tecniche

Codice INECO	Codice Total	L(mm)	Lar. (mm)	Prezzo
4281620018	THT511836	100	18	4.32 €

UTENSILI DA TAGLIO

INDUSTRIAL TOTAL

Nome / Famiglia

42820

CUTTER IN ALLUMINIO CON 6 LAME

Descrizione

Cutter per lame a settori, corpo in alluminio e portalama in acciaio, impugnatura ergonomica antiscivolo, pulsante di blocco automatico della lama e rotella aggiuntiva di sicurezza, con serbatoio lame

Packaging



Specifiche tecniche

Codice INECO	Codice Total	L(mm)	Lar. (mm)	Prezzo
4282010018	TG5121806	100	18	10.65 €

Nome / Famiglia

42820

COLTELLO LAMA RETRATTILE CON 6 LAME

Descrizione

Coltello a lama retrattile, corpo in alluminio con impugnatura ergonomica antiscivolo, sistema di cambio rapido della lama

6 pz



Specifiche tecniche

Codice INECO	Codice Total	L(mm)	Lar. (mm)	Prezzo
4282010019	THT5126128	61	19	8.36 €

Nome / Famiglia

42822

COLTELLO PIEGHEVOLE A LAMA FISSA

Descrizione

Coltello pieghevole a lama fissa, corpo in lega di alluminio

Caratt.



Specifiche tecniche

Codice INECO	Codice Total	L(mm)	Lar. (mm)	Prezzo
4282220019	THT5136236	61	19	10.30 €



Packaging



UTENSILI DA TAGLIO



42824
10 LAME A SETTORI

10 lame a settori in acciaio ad alta resistenza, in contenitore di plastica



Codice INECO	Codice Total	L(mm)	Lar. (mm)	Prezzo
4282418100	THT519112	100	18	1.34 €

42826
10 LAME PER COLTELLI

10 lame per coltelli in acciaio ad alta resistenza, in contenitore di plastica

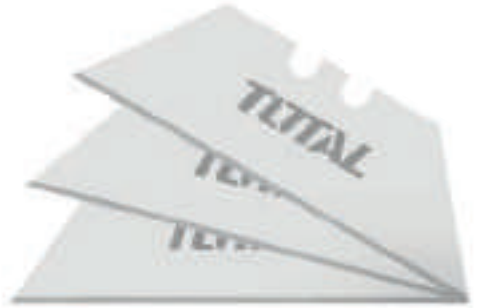

Codice INECO	Codice Total	L(mm)	Lar. (mm)	Prezzo
4282661019	THT519001	61	19	2.04 €

42828
COLTELLINO MULTIFUNZIONE

Coltellino multifunzione, manico in alluminio, 15 funzioni

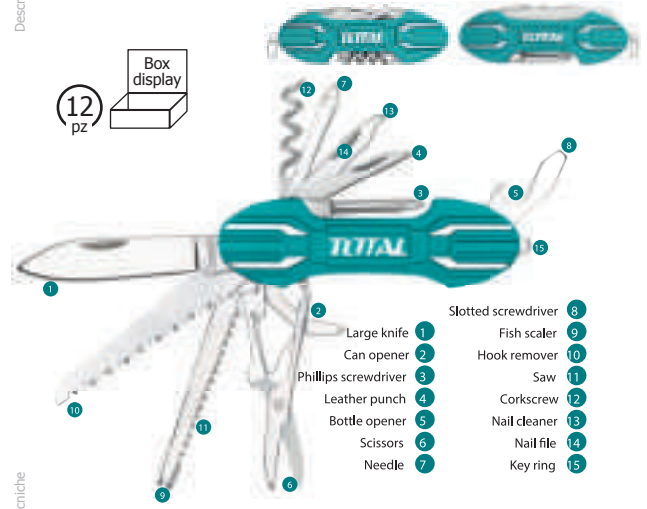
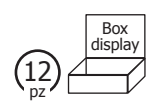

Codice INECO	Codice Total	Misura	Funzioni	Prezzo
4282800001	THMFK0156	95 (mm)	15	12.05 €

42828
UTENSILE MULTIFUNZIONE

Utensile multifunzione con impugnatura antiscivolo, 15 funzioni



Codice INECO	Codice Total	Misura	Funzioni	Prezzo
4282800002	TFMFT01151	95 (mm)	15	29.10 €

SERRAGGIO**INDUSTRIAL TOTAL**

Nome / Famiglia

43702**STRETTOIO A VITE**

Specifiche tecniche

Codice INECO	Codice Total	Dimensioni (mm)	Forza (Max)		Prezzo
43702050150	THT1320501	150x50	170 kg	10	6.34 €
43702050250	THT1320503	250x50	179 kg	10	6.96 €
43702080300	THT1320801	300x80	270 kg	1	12.65 €
43702120300	THT1321201	300x120	270 kg	1	19.00 €
43702120400	THT1321202	400x120	450 kg	1	21.60 €
43702120500	THT1321203	500x120	450 kg	1	22.80 €
43702120800	THT1321204	800x120	450 kg	1	27.90 €
437021401000	THT1321401	1000x140	550 kg	1	48.10 €

Nome / Famiglia

43704**STRETTOIO RAPIDO AD UNA MANO
REVERSIBILE**

Descrizione

Forza massima di serraggio 60 kg

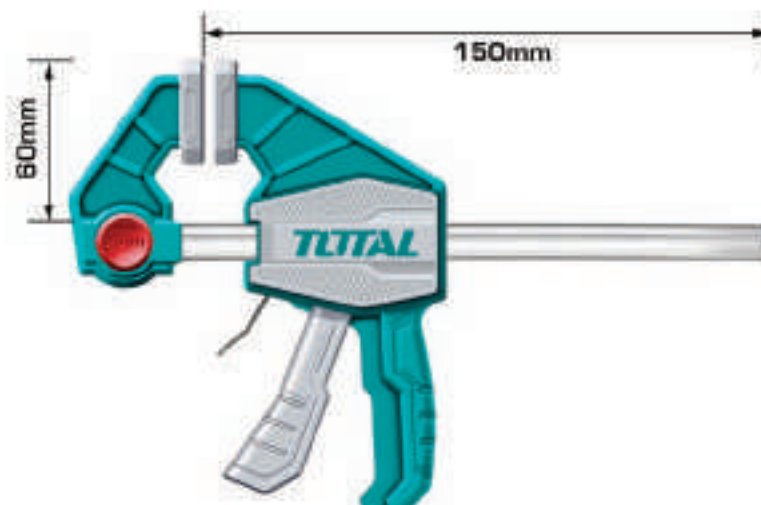

Specifiche tecniche

Codice INECO	Codice Total	Dimensioni (mm)	Forza (Max)		Prezzo
43704063150	THT1340601	150x63	60 kg	1	6.96 €
43704063300	THT1340602	300x63	60 kg	1	8.24 €
43704063450	THT1340603	450x62	60 kg	1	9.50 €

SERRAGGIO



Nome / Famiglia

43704

STRETTOIO RAPIDO AD UNA MANO REVERSIBILE

Descrizione

Forza massima di serraggio 135 kg

Caratt.

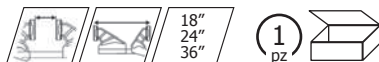

Specifiche tecniche

Codice INECO	Codice Total	Dimensioni (mm)	Forza (max)	Prezzo
43704080450	THT1346801	450x80	135 kg	30.30 €
43704080600	THT1346802	600x80	135 kg	33.00 €
43704080900	THT1346803	900x80	135 kg	39.00 €

Nome / Famiglia

43706

MORSETTO A C IN GHISA



Specifiche tecniche

Codice INECO	Codice Total	Dimensioni (mm)	Imb.	Prezzo
4370600100	THT13141	100	6	10.15 €
4370600125	THT13151	125	4	13.30 €
4370600150	THT13161	150	4	15.85 €

Nome / Famiglia

43708

MORSETTO A MOLLA



Specifiche tecniche

Codice INECO	Codice Total	Dimens. (mm)	Forza di serraggio (Kg)	Apertura max. (mm)	Prezzo
4370800004	THT13342	110	12	50	1.52 €
4370800006	THT13362	150	15	68	2.16 €

MANUTENZIONI VARIE



Nome / Famiglia

42814 RASCHIETTO

Descrizione

Raschietto con manico ergonomico bimatereale, con 6 lame in acciaio ad alta resistenza SK5

Caratt.



Packaging



Specifiche tecniche

Codice INECO	Codice Total	L(mm)	Peso (gr)	Prezzo
4281400300	THT183201	300	260	14.95 €

Nome / Famiglia

42815 RASCHIETTO PER VETRO

Descrizione

Raschietto ideale per rimozione vernice dai vetri, lama 61 x 19 mm

Caratt.



Packaging



Specifiche tecniche

Codice INECO	Codice Total	Lunghezza (mm)	Prezzo
4281500175	THT181751	175	2.18 €

Nome / Famiglia

42832 SET 4 UNCINI

Caratt.

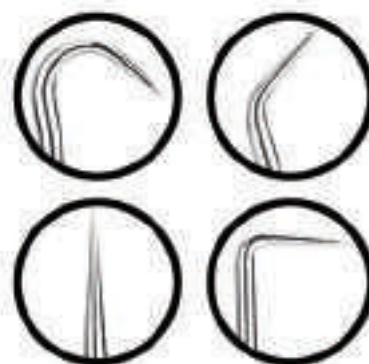

Packaging



Specifiche tecniche

Codice INECO	Codice Total	Prezzo
4283200001	TPHSK0401	6.34 €

MANUTENZIONI VARIE



44814

GRAFFATRICE 3 IN 1

Nome / Famiglia

Descrizione

Graffatrice 3 in 1 in metallo per graffe 4-14 mm, graffe ad U 10-12 mm e chiodi 4-14 mm, con rotella di regolazione della potenza

Packaging



3 in 1



Specifiche tecniche

Codice INECO	Codice Total	Prezzo
4481400001	THT31143	14.55 €

44816

CHIODI PER GRAFFATRICE 3 IN 1

Nome / Famiglia

Descrizione

Chiodi 10 mm x 2 mm x 1,2 mm



Specifiche tecniche

Codice INECO	Codice Total	Pezzi confezione	Prezzo
4481600001	THT39103	1000	1.66 €

44818

GRAFFE TONDE PER GRAFFATRICE 3 IN 1

Nome / Famiglia

Descrizione

Graffe 12mm x 6,3 mm x 1,2 mm



Specifiche tecniche

Codice INECO	Codice Total	Pezzi confezione	Prezzo
4481800002	THT39124	1000	1.90 €

44819

GRAFFE QUADRE PER GRAFFATRICE 3 IN 1

Nome / Famiglia

Descrizione

Spessore: 1,2 mm
 Compatibili con graffatrice THT31142, THT31143



Specifiche tecniche

Codice INECO	Codice Total	L (mm)	Pezzi conf.	Prezzo
4481900008	THT3982	8	1000	1.68 €
4481900010	THT39102	10	1000	1.88 €
4481900012	THT39122	12	1000	2.18 €

MANUTENZIONI VARIE



Nome / Famiglia

44802

RIVETTATRICE MANUALE

Descrizione

Rivettatrice manuale in alluminio per rivetti da 2,4 mm, 3,2 mm, 4 mm, 4,8 mm



Packaging



Specifiche tecniche



Codice INECO	Codice Total	L(mm)	M. Rivetto Ø (mm)	Prezzo
4480200260	THT32105	260	2.4 - 3.2 - 4.8	14.55 €

Nome / Famiglia

44803

RIVETTATRICE DI POTENZA COMPATTA

Descrizione

Rivettatrice di potenza compatta con serbatoio portasteli, per rivetti fino a Ø 6,4 mm



Specifiche tecniche



Rivetto in acciaio inossidabile
3,2 mm, 4,0 mm, 4,8 mm, 6,0 mm

Rivetto in alluminio e acciaio
3,2 mm, 4,0 mm, 4,8 mm, 6,0 mm, 6,4 mm

Codice INECO	Codice Total	Lunghezza (mm)	Prezzo
4480300330	THT32131	330 (13")	30.80 €

Nome / Famiglia

44804

RIVETTATRICE DI POTENZA

Descrizione

Rivettatrice di potenza in acciaio ed alluminio, per rivetti da 3,2 mm, 4 mm, 4,8 mm



Specifiche tecniche



Codice INECO	Codice Total	L(mm)	M. Rivetto Ø (mm)	Prezzo
4480400420	THT32176	420	3.2 - 4 - 4.8	22.80 €

Nome / Famiglia

44805

RIVETTATRICE MANUALE CON TESTA ORIENTABILE

Descrizione

Rivettatrice manuale con testa orientabile a 360°, per rivetti da 2,4 mm, 3,2 mm, 4 mm, 4,8 mm



Packaging



Specifiche tecniche

Codice INECO	Codice Total	Prezzo
4480500001	THT32106	21.60 €

MANUTENZIONI VARIE



Nome / Famiglia

44806

PISTOLA PER SILICONE



Specifiche tecniche

Codice INECO	Codice Total	L(mm)	Prezzo
4480600001	THT20209	235	4.70 €

Nome / Famiglia

44806

PISTOLA PER SILICONE IN ALLUMINIO

Descrizione

Pistola per silicone con manico in alluminio con doppio piattello di spinta ed ago per la pulizia della cartuccia



Specifiche tecniche

Codice INECO	Codice Total	L(mm)	Prezzo
4480600002	THT21309	235	6.46 €

Nome / Famiglia

44806

PISTOLA PER SILICONE CON TUBO IN ALLUMINIO

Descrizione

Pistola per silicone con tubo in alluminio e manico robusto, con piattello di spinta rinforzato, adatta anche per sacchetti



Specifiche tecniche

Codice INECO	Codice Total	L(mm)	Prezzo
4480600003	THT20109	235	14.55 €

MANUTENZIONI VARIE



47234
PISTOLA PER COLLA A CALDO 20 W

6 pz



2 pcs
 Glue gun stick



Potenza assorbita: 20W(100W)
Tensione: 220-240V~50/60Hz
Portata: 13-18g/min
Diametro colla: 11.2mm
 2 stick colla da 11.2 mm inclusi

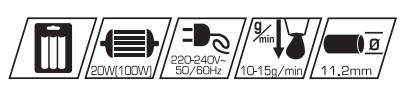

Codice INECO	Codice Total	Prezzo
4723400020	TT101116	10.90 €

47236
STICK COLLA A CALDO

10 pz

Diametro: 11.2mm
Lunghezza: 20cm
 Confezione da 6 pezzi



Codice INECO	Codice Total	Prezzo
4723600006	TACGT2061	4.12 €

47233
SALDATORE ELETTRICO A STAGNO, TESTA A PUNTA

Saldatore elettrico a stagno con testa a punta a lunga durata

25 pz



Potenza assorbita: 60W
Tensione: 220-240V~50/60Hz
Tempo di riscaldamento: 3~5 min

Codice INECO	Codice Total	Prezzo
4723300060	TET1606	14.65 €

47235
SALDATORE ELETTRICO A STAGNO, TESTA PIATTA

Saldatore elettrico a stagno con testa piatta a lunga durata

25 pz



Potenza assorbita: 60W
Tensione: 220-240V~50/60Hz
Tempo di riscaldamento: 3~5 min

Codice INECO	Codice Total	Prezzo
4723500060	TET2606	15.00 €

MANUTENZIONI VARIE

INDUSTRIAL TOTAL

Nome / Famiglia

44820

VENTOSA PER SOLLEVAMENTO

Descrizione

Ventosa per piastrelle,
trazione massima 25 kg, manico in ABS

Caratt.

25kg
max3
pz

Specifiche tecniche

Codice INECO	Codice Total	Trazione max	Diametro	Prezzo
448200025	TSP01251	25 kg	115 mm	7.90 €

Packaging



Nome / Famiglia

44821

VENTOSA PER SOLLEVAMENTO DOPPIA

Descrizione

Ventosa per piastrelle,
trazione massima 50 kg, manico in ABS

Caratt.

50kg
max3
pz

Specifiche tecniche

Codice INECO	Codice Total	Trazione max	Diametro	Prezzo
4482100050	TSP02501	50 kg	115 mm	15.00 €

Packaging



MANUTENZIONI VARIE



43802

COMPRESSORE A LEVA PER GRASSO

Nome / Famiglia

Descrizione

Compressore a leva per grasso



Capacità: 400CC / 14oz
 Riempimento: cartuccia 400CC
 Pressione di lavoro: 4500 psi
 Pressione di scoppio: psi
 Diametro esterno tubo: 55mm
 Tubo in acciaio 1.2mm

Accessori inclusi:

- 1 tubo in nylon ad alta pressione da 30 cm
- 1 beccuccio metallico

Specifiche tecniche



Codice INECO	Codice Total	Capacità	P(psi)	Prezzo
4380200400	THT111051	400cc	4500-10000	22.20 €



43802

COMPRESSORE A LEVA PER GRASSO A DOPPIO PISTONE

Nome / Famiglia

Descrizione

Compressore a leva per grasso a doppio pistone



Capacità: 600CC / 21 Oz
 Riempimento: cartuccia 600CC
 Pressione di lavoro: 3600psi
 Pressione di scoppio: 6000psi
 Diametro esterno tubo: 55mm
 Tubo in acciaio 1.2mm di spessore con becco in alluminio

Accessori inclusi:

- 1 tubo flessibile in nylon ad alta pressione da 30 cm
- 1 beccuccio metallico

Specifiche tecniche



Codice INECO	Codice Total	Capacità	P(psi)	Prezzo
4380200600	THT111062	600cc	3600-6000	51.00 €





SEGHE E SEGHETTI

430

lama in acciaio
alta qualità 65Mn

Manico in alluminio
con impugnatura
ergonomica
bimateriale

Sistema di
cambio rapido
della lama

Corpo in metallo
ad alta resistenza

Sistema di **cambio**
rapido della lama

43012

**SEGHETTO
CAMBIO RAPIDO
DELLA LAMA**

Seghetto in metallo ad alta resistenza doppia impugnatura per i lavori più gravosi e sistema di cambio rapido della lama



SEGHE E SEGHETTI



43002

SEGACCIO PER LEGNO

Nome / Famiglia

Descrizione Segaccio per legno con impugnatura ergonomica bimateriale, lama in acciaio alta qualità SK5, denti temprati 7 TPI, tripla affilatura della lama.



Materiale: Taiwan SK5



Specifiche tecniche

Codice INECO	Codice Total	Dimensioni (mm)	Prezzo
4300200400	THT55166D	400	15.20 €
4300200500	THT55206D	500	17.75 €

43004

SEGA A DORSO

Nome / Famiglia

Descrizione Sega a dorso con manico ergonomico bimateriale

Caratt.

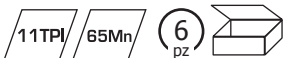

Packaging



Specifiche tecniche

Codice INECO	Codice Total	Lunghezza (mm)	Prezzo
4300400300	THT59126B	300	10.00 €

43004

SEGA A DORSO CON SUPPORTO TAGLIACORNICI

Nome / Famiglia

Descrizione

Sega a dorso con manico ergonomico bimateriale e supporto tagliacornici

Caratt.

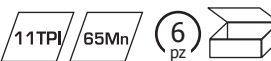

Specifiche tecniche

Codice INECO	Codice Total	Lunghezza (mm)	Prezzo
4300410300	THT59126	300	21.00 €

SEGHE E SEGHETTI



Nome / Famiglia

43006

SEGA A FORETTO

Descrizione

Sega a foretto con impugnatura ergonomica bimatériale, lama in acciaio alta qualità SK5, denti temprati 7 TPI, tripla affilatura della lama.

Caratt.



Packaging



Specifiche tecniche



Codice INECO	Codice Total	Lunghezza (mm)	Prezzo
4300600300	THCS3006	300	8.86 €



Nome / Famiglia

43008

SEGHETTO PER CARTONGESSO

Descrizione

Seghetto per cartongesso con impugnatura ergonomica bimatériale, lama in acciaio alta qualità SK5, denti temprati 8 TPI, tripla affilatura della lama.

Caratt.



Packaging



Specifiche tecniche



Codice INECO	Codice Total	Lunghezza (mm)	Prezzo
4300800150	THWBSW66	150	8.86 €



SEGHE E SEGHETTI



Nome / Famiglia

43016**SEGHETTO**

Descrizione

Seghetto in metallo con impugnatura ergonomica bimatériale, lama orientabile



Specifiche tecniche

Codice INECO	Codice Total	Misura	Prezzo
4301600300	THT54166	300mm	7.86 €

Nome / Famiglia

43014**SEGHETTO**

Descrizione

Seghetto in metallo con impugnatura ergonomica bimatériale, lama orientabile



Packaging



Specifiche tecniche

Codice INECO	Codice Total	Misura	Prezzo
4301400300	THT541026	300mm	13.45 €

SEGHE E SEGHETTI



Nome / Famiglia

43012

SEGHETTO CAMBIO RAPIDO DELLA LAMA

Descrizione

Seghetto in metallo ad alta resistenza doppia impugnatura per i lavori più gravosi e sistema di cambio rapido della lama



Packaging



Specifiche tecniche



Codice INECO	Codice Total	Misura	Prezzo
4301200300	THT54106	300mm	18.75 €

SEGHE E SEGHETTI



Nome / Famiglia
43020
SEGHETTO 150 MM

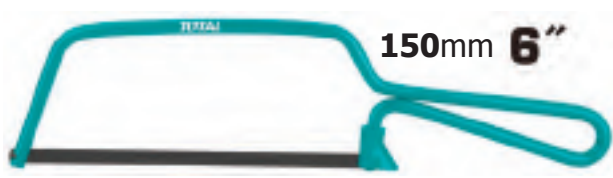
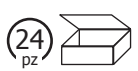

Specifiche tecniche

Codice INECO	Codice Total	Misura	Prezzo
4302000150	THMHF1501	150 mm	2.42 €

Nome / Famiglia
43022
SEGHETTO 150 MM IMPUGNATURA

Descrizione
 Seghetto con impugnatura antiscivolo e corpo in alluminio



Specifiche tecniche

Codice INECO	Codice Total	Misura	Prezzo
4302200150	THMHF1503	150 mm	6.96 €

Nome / Famiglia
43018
LAMA BIMETALLICA PER SEGHETTO 300 MM

Descrizione
 Lama bimetallica di ricambio per seghetto 300 mm

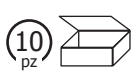

Specifiche tecniche

Codice INECO	Codice Total	N° di denti	Prezzo
4301800018	THT572188	18 T	3.18 €
4301800024	THT572248	24 T	3.18 €

Nome / Famiglia
43024
LAME PER SEGHETTO 150 MM

Descrizione
 Lame per seghetto 150 mm in acciaio 65Mn, 24T

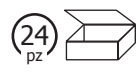

Specifiche tecniche

Codice INECO	Codice Total	Pezzi	Prezzo
4302400150	TMHSB1501	10	4.18 €

LIME E RASPE



43206

SET 5 LIME CON IMPUGNATURA

Descrizione: Set 5 lime per ferro con impugnatura ergonomica bimateriale. In acciaio T12, manico ergonomico bimateriale, lunghezza 200 mm. Taglio mezzo dolce



Specifiche tecniche

Codice INECO	Codice Total	Spec	L (mm)	Prezzo
432060005	THT918516	1 lima piatta	200	27.90 €
		1 lima mezzotonda		
		1 lima tonda		
		1 lima triangolare		
		1 lima quadrata		

43206

SET 6 MINI LIME CON IMPUGNATURA

Descrizione: Set 6 mini lime per ferro con impugnatura ergonomica bimateriale. Taglio mezzo dolce

Caratt.



Specifiche tecniche

Codice INECO	Codice Total	L(mm)	Prezzo
432060006	THT91462	140	7.48 €

LIME E RASPE



Nome / Famiglia

43208

SET 3 RASPE CON IMPUGNATURA

Descrizione

Set 3 raspe per legno con impugnatura ergonomica bimateriale. Taglio mezzo dolce



Specifiche tecniche

Codice INECO	Codice Total	Spec	L (mm)	Prezzo
432080003	THT918326	raspa tonda x1	200	15.85 €
		raspa mezzatonda x1		
		raspa piatta x1		

TOTAL

One-Stop Tools Station

STRUMENTI DI MISURA**INDUSTRIAL TOTAL**

Nome / Famiglia

44004**LIVELLE A BOLLA BASE FRESATA
E PRISMATICA**

Descrizione

Livella a 3 bolle in alluminio rinforzato, base prismatica per misure su tubi, doppia superficie fresata, con tappi in gomma antiurto, precisione 0,5 mm/m

Caratt.



Specifiche tecniche

Codice INECO	Codice Total	L(cm)	Spessore(mm)	Prezzo
4400400300	TMT2306	30	1.5	11.40 €
4400400400	TMT2406	40	1.5	13.30 €
4400400600	TMT2606	60	1.5	18.35 €
4400400800	TMT2806	80	1.5	21.60 €
4400401000	TMT21006	100	1.5	25.30 €

Nome / Famiglia

44008**LIVELLA A BOLLA
TORPEDO MAGNETICA**

Descrizione

Livella Torpedo a 3 bolle, in alluminio, magnetica

Caratt.

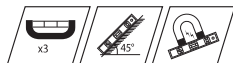

Specifiche tecniche

Codice INECO	Codice Total	L(cm)	Prezzo
4400800225	TMT2235	22.5	4.32 €

STRUMENTI DI MISURA



44016

FLESSOMETRO

Nome / Famiglia

Descrizione

Flessometro con nastro in acciaio, conforme al certificato MID II, rivestito in gomma antiscivolo, con 3 funzioni di arresto



Specifiche tecniche

Codice INECO	Codice Total	Lunghezza nastro	Larghezza nastro	Prezzo
4401600003	TMT126031ME	3 m	16 mm	4.20 €
4401600005	TMT126052ME	5 m	25 mm	6.86 €
4401600008	TMT126081ME	8 m	25 mm	9.96 €

44022

TERMOMETRO INFRAROSSI

Nome / Famiglia

Descrizione

Temperatura: -30°C~550°C (-22°F~1022°F)
 Display a colori
 D:S=12:1
 Tempo di risposta: <0.5s
 Laser: <1mW(630nm~650nm) 12 punti
 Spegnimento automatico
 Temperatura di funzionamento: -10°C~60°C (14°F~140°F)
 Allarme temperatura



Packaging



Specifiche tecniche

Codice INECO	Codice Total	Prezzo
4402200001	THIT015501	41.80 €



UTENSILI PER ELETTRICISTA

434

Corpo in lamiera
d'acciaio tranciata

3 in 1,
troncaviti,
troncafilì
e spellafilì

impugnatura
in **PVC**

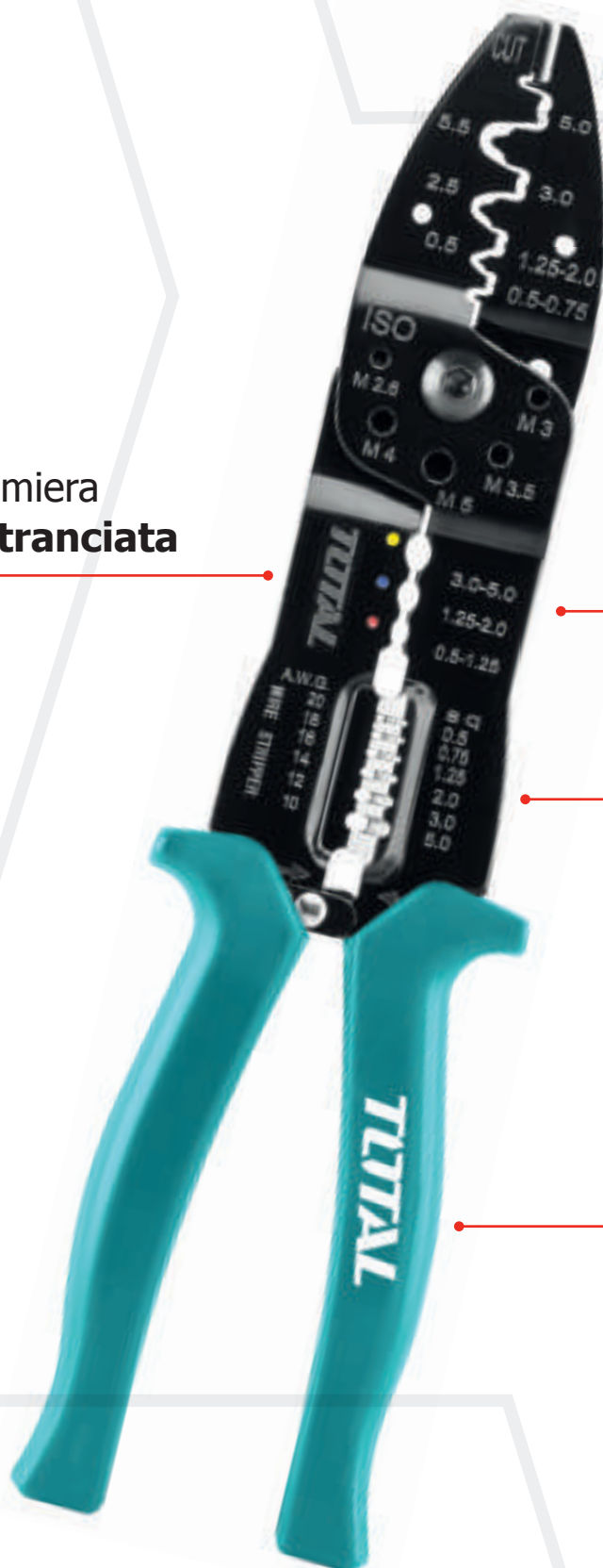

43418

PINZA PER CAPICORDA

Pinza multifunzione per serrare capicorda, troncaviti filettate M 2,6-M5, spellare 6 diversi diametri di cavi, impugnatura ergonomica antiscivolo

UTENSILI PER ELETTRICISTA



Nome / Famiglia

43408 GIRAVITI ISOLATI

Descrizione

Giraviti isolati con impugnatura ergonomica bimateriale

Caratt.

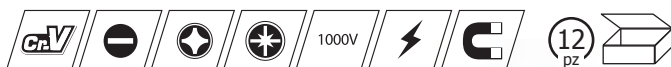

Specifiche tecniche

Codice INECO	Codice Total		L(mm)	V	Prezzo
4340830075	THTIS3075	3.0	75	1000	2.80 €
4340840100	THTIS4100	4.0	100	1000	3.30 €
4340855125	THTIS5125	5.5	125	1000	3.94 €
4340865150	THTIS6150	6.5	150	1000	5.06 €
4340800060	THTISPH060	PH0	60	1000	2.66 €
4340801080	THTISPH180	PH1	80	1000	3.42 €
4340801081	THTISPZ180	PZ1	80	1000	3.36 €
4340802101	THTISPH2100	PH2	100	1000	4.44 €
4340802100	THTISPZ2100	PZ2	100	1000	4.44 €



Nome / Famiglia

43409 SET 3 GIRAVITI ISOLATI

Descrizione

Set 3 pezzi giraviti isolati impronte assortite

Caratt.



Specifiche tecniche

Codice INECO	Codice Total	Prezzo
4340900001	THTIS036	8.76 €



UTENSILI PER ELETTRICISTA



Nome / Famiglia
 Descrizione
 Caratt.

43410
SET 6 PEZZI GIRAVITE ISOLATI IMPRONTE ASSORTITE

Set 6 pezzi di giraviti isolati impronte assortite

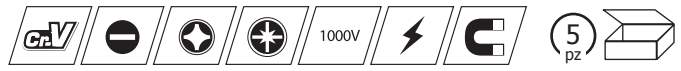

Codice INECO	Codice Total	Spec	Prezzo
434100001	THTIS566	SL3.0x75 PH0x60, SL4.0x100 PH1x80, SL6.5x150 PH2x100	24.10 €



Nome / Famiglia

43402
PINZA UNIVERSALE ISOLATA



Codice INECO	Codice Total	Lunghezza (mm)	Prezzo
4340200160	THTIP2161	160 (6")	14.10 €
4340200180	THTIP2171	180 (7")	15.35 €
4340200200	THTIP2181	200 (8")	16.90 €

Nome / Famiglia

43403
PINZA REGOLABILE ISOLATA

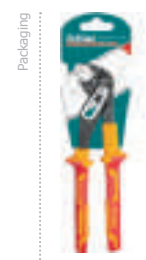

Codice INECO	Codice Total	Lunghezza (mm)	Prezzo
4340300250	THTIP28101	250 (10")	17.50 €

UTENSILI PER ELETTRICISTA



Nome / Famiglia

43407

**PINZA BECCHI LUNGI
MEZZITONDI CURVI ISOLATA**

Caratt.

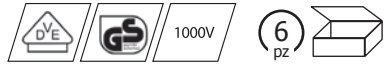

Packaging



Specifiche tecniche

Codice INECO	Codice Total	Lunghezza (mm)	Prezzo
4340700200	THTIP2481	200 (8")	16.30 €

Nome / Famiglia

43406

**PINZA BECCHI LUNGI
MEZZITONDI ISOLATA**

Caratt.

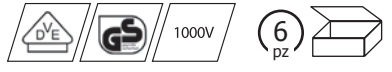

Packaging



Specifiche tecniche

Codice INECO	Codice Total	Lunghezza (mm)	Prezzo
4340600160	THTIP2361	160 (6")	13.05 €
4340600200	THTIP2381	200 (8")	15.10 €

Nome / Famiglia

43404

**TRONCHESE DIAGONALE
ISOLATO**

Caratt.



Packaging



Specifiche tecniche

Codice INECO	Codice Total	Lunghezza (mm)	Prezzo
4340400160	THTIP2261	160 (6")	14.95 €
4340400180	THTIP2571	180 (7")	16.30 €

Nome / Famiglia

43421

TAGLIACAVI ISOLATO

Caratt.

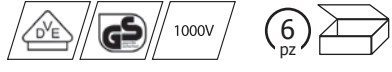

Packaging



Specifiche tecniche

Codice INECO	Codice Total	Lunghezza mm	Prezzo
4342100160	THTIP2761	160 (6")	12.80 €

UTENSILI PER ELETTRICISTA



Nome / Famiglia

43411

SET 3 PINZE ISOLATE

Descrizione

Set di 3 pinze isolate al cromo-vanadio, finitura nera e lucida

Caratt.



- 1 pinza universale isolata 8"
- 1 pinza becchi lunghi mezzitondi isolata 6"
- 1 tronchese diagonale isolato 6"

Specifiche tecniche



Codice INECO	Codice Total	Prezzo
4341100001	THT2K0302	39.30 €



Nome / Famiglia

43419

SET 6 UTENSILI ASSORTITI ISOLATI

Descrizione

Set di utensili isolati VDE da 6 pezzi



- 1 cacciavite isolato SL5.5x125mm
- 1 cacciavite isolato SL4.0x100mm
- 1 cacciavite isolato PH2x100mm
- 1 pinza combinata isolata da 7"
- 1 pinza da taglio diagonale isolata da 6"
- 1 tester prova tensione (100-500VAC)

Specifiche tecniche



Codice INECO	Codice Total	Prezzo
4341900006	THKIST3062	37.50 €

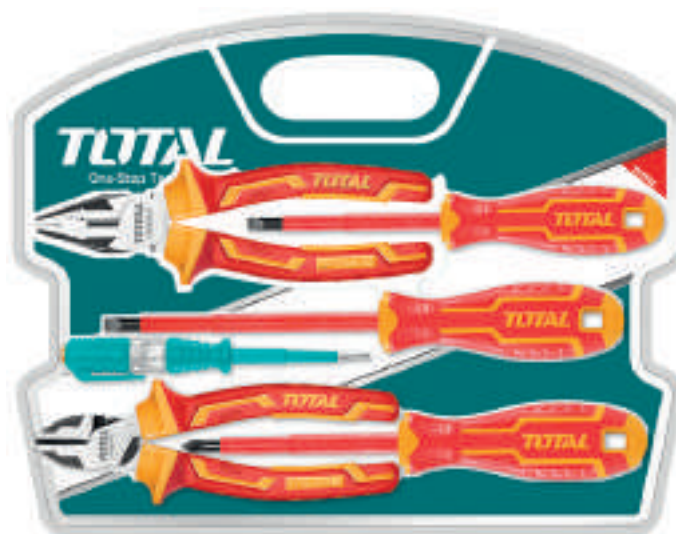

UTENSILI PER ELETTRICISTA



Nome / Famiglia
43413
PINZA SPELLAFILI CON VITE ISOLATA



Specifiche tecniche

Codice INECO	Codice Total	Lunghezza (mm)	Prezzo
4341300160	THTIP2661	160(6")	15.85 €

Nome / Famiglia
43412
PINZA SPELLAFILI CON VITE

Descrizione
 Pinza spellafili con vite di regolazione della profondità di spellatura, impugnatura ergonomica in bimatereale, finitura lucida



Specifiche tecniche

Codice INECO	Codice Total	Lunghezza (mm)	Prezzo
4341200160	THT25616	160(6")	9.76 €

Nome / Famiglia
43414
PINZA SPELLAFILI

Descrizione
 Pinza spellafili con impugnatura ergonomica antiscivolo



Specifiche tecniche

Codice INECO	Codice Total	Misura	Materiale	Prezzo
4341400180	THT1591	7"	65Mn	12.40 €

Nome / Famiglia
43416
PINZA SPELLAFILI AUTOMATICA

Descrizione
 Pinza spellafili automatica piegata a 90°, con funzione di taglio e spellatura, capacità 0,5- 6 mm?

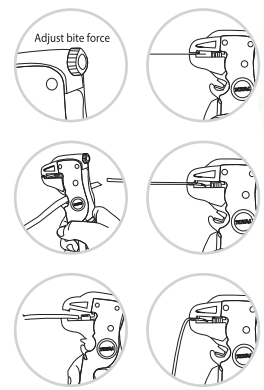

Specifiche tecniche

Codice INECO	Codice Total	Misure	Prezzo
4341600560	THT15606	0,5-6 mm	14.85 €

UTENSILI PER ELETTRICISTA



Nome / Famiglia
43420
TAGLIACAVI

Descrizione
 Tagli cavi per cavi in rame ed alluminio, impugnatura antiscivolo, finitura nera e lucida

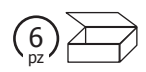

Specifiche tecniche

Codice INECO	Codice Total	L(mm)	Prezzo
4342000200	THT11581	200(8")	7.98 €

Nome / Famiglia
43422
TAGLIACAVI A GRANDE EFFETTO

Descrizione
 Tagli cavi a grande effetto per cavi in rame ed alluminio, impugnatura antiscivolo



Specifiche tecniche

Codice INECO	Codice Total	L(mm)	Prezzo
4342200250	THT115102	250(10")	10.65 €

Nome / Famiglia
43427
FORBICI DA ELETTRICISTA 178 MM

Descrizione
 Forbici da elettricista in acciaio inossidabile, misura 178mm, lama dentata, superficie sabbata



Specifiche tecniche

Codice INECO	Codice Total	Lunghezza (mm)	Prezzo
4342700178	THT117871	178 (8")	8.58 €

UTENSILI PER ELETTRICISTA



Nome / Famiglia

42831

FORBICI DA ELETTRICISTA INOX 145 MM

Descrizione

Forbice per elettricisti 145 mm in acciaio INOX, impugnatura antiscivolo bimatereale, lama microdentata

Caratt.

Stainless Steel
3CR14
3Core Bronze Wire
3mm
With Teeth
1 pz



Specifiche tecniche



Codice INECO	Codice Total	Lunghezza (mm)	Prezzo
4283100001	THT1155871	145	6.96 €

UTENSILI PER ELETTRICISTA



43417

PINZA SPELLAFILI AUTOMATICA TRIPLA FUNZIONE

Nome / Famiglia

Descrizione

Pinza spellafili automatica con tripla funzione di crimpatura, spelatura, taglio

Caratt.



Intervallo di fili

10AWG~24AWG(0.2~6mm²)

per crimpare i terminali isolati 0,5-6 mm² (10-22 AWG)

per crimpare i terminali non isolati 0,5-6 mm² (4-22 AWG)

per crimpare i terminali di accensione: 7-8mm²



Specifiche tecniche



Codice INECO	Codice Total	Lunghezza mm	Prezzo
4341700210	THT15246	210 (8,25")	21.80 €

43418

PINZA PER CAPICORDA

Nome / Famiglia

Descrizione

Pinza multifunzione per serrare capicorda, troncare viti filettate M 2,6-M5, spellare 6 diversi diametri di cavi, impugnatura ergonomica antiscivolo

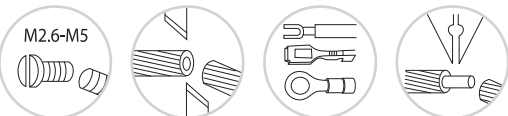

Specifiche tecniche



Codice INECO	Codice Total	Misura	Prezzo
4341800254	THT15101	254mm	13.80 €

Packaging



43425

CRIMPATRICE PER CAPICORDA TELEFONIA E TRASMISSIONE DATI

Nome / Famiglia

Descrizione

Crimpatrice per spine modulari, per crimpare cavi per linee di rete e telefoniche, tripla funzioni: crimpatura, spelatura, taglio

Caratt.



Intervallo di crimpatura 4P, 6P, 8P,

Specifiche tecniche



Codice INECO	Codice Total	Lunghezza (mm)	Prezzo
4342500200	TMPC4468P	200 (8")	12.65 €

UTENSILI PER ELETTRICISTA



Nome / Famiglia

43432

PINZA A CRICCHETTO PER CAPICORDA NON ISOLATI APERTI

Descrizione

Crimpatrice a cricchetto, per linguette e prese non isolate, pressione regolabile, adattabile a numerosi terminali

Caratt.



Intervallo di crimpatura 0,5-6mm²
AWG 20-14

Specifiche tecniche



Codice INECO	Codice Total	Lunghezza (mm)	Prezzo
4343200230	THCPC0506	230 (9")	19.30 €

Nome / Famiglia

43433

PINZA A CRICCHETTO PER CAPICORDA NON ISOLATI CHIUSI

Descrizione

Crimpatrice a cricchetto, per terminali non isolati, pressione regolabile, adattabile a numerosi terminali

Caratt.

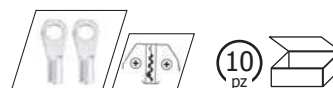

Intervallo di crimpatura 1,5-6mm²
AWG 20-14

Specifiche tecniche



Codice INECO	Codice Total	Lunghezza (mm)	Prezzo
4343300230	THCPL1506	230 (9")	19.30 €

Nome / Famiglia

43434

PINZA A CRICCHETTO PER CAPICORDA ISOLATI

Descrizione

Crimpatrice a cricchetto, per terminali isolati e connettori di testa, pressione regolabile, adattabile a numerosi terminali

Caratt.

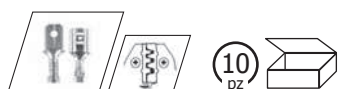

Intervallo di crimpatura 0,5-6mm²
AWG 20-8

Specifiche tecniche



Codice INECO	Codice Total	Lunghezza (mm)	Prezzo
4343400230	THCPJ0506	230 (9")	19.30 €

Nome / Famiglia

43435

PINZA A CRICCHETTO PER CAPICORDA A TUBETTO

Descrizione

Crimpatrice a cricchetto, per terminali tubolari nudi e terminali preisolati, pressione regolabile, adattabile a numerosi terminali

Caratt.



Intervallo di crimpatura 0,25-10mm²
AWG 23-7

Specifiche tecniche



Codice INECO	Codice Total	Lunghezza (mm)	Prezzo
4343500160	THCPG2510	160 (6")	28.30 €

UTENSILI PER IDRAULICO

436



**Azione di taglio
progressiva** con
il minimo sforzo

**Dispositivo
di apertura
automatica**
delle lame per un
pratico utilizzo
con una sola
mano

**Corpo in
alluminio**
per la massima
leggerezza
e resistenza

43608

**TAGLIATUBI
PER TUBI
IN PLASTICA**

Taglia tubi per tubi e profilati in
plastica, corpo in alluminio

UTENSILI PER IDRAULICO



43606

GIRATUBI SVEDESE 45°

Nome / Famiglia

Descrizione

Giratubi modello svedese con ganasce parallele a 45°



Specifiche tecniche

Codice INECO	Codice Total	L (mm)	Ø (mm)	Prezzo
4360600001	THT172013	1"	40	16.85 €
4360600012	THT172153	1" - 1/2"	55	25.90 €
4360600002	THT172023	2"	67	41.80 €

43604

GIRATUBI SVEDESE GANASCE PIANE A 90°

Nome / Famiglia

Descrizione

Giratubi modello svedese con ganasce a 90°



Specifiche tecniche

Codice INECO	Codice Total	L (")	Ø (mm)	Prezzo
4360400001	THT172011	1"	40	16.85 €
4360400012	THT172151	1-1/2"	55	25.90 €
4360400002	THT172021	2"	67	41.80 €

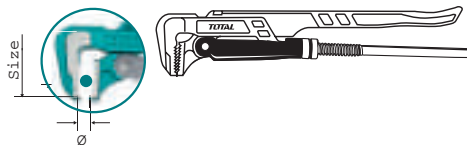

UTENSILI PER IDRAULICO



Nome / Famiglia

43602

GIRATUBI AMERICANO

Descrizione

Giratubi modello americano, corpo in ghisa e ganasce in acciaio al carbonio, finitura nera e lucida



Specifiche tecniche

Codice INECO	Codice Total	L(mm)	Ø (mm)	Prezzo
4360200200	THT170806	200	27	9.24 €
4360200250	THT171006	250	34	11.80 €
4360200350	THT171146	350	50	17.75 €
4360200450	THT171186	450	60	25.30 €
4360200915	THT171366	915	85	72.50 €

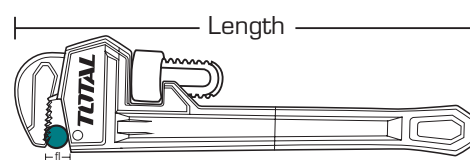

Nome / Famiglia

43612

GIRATUBI A RIPRESA AUTOMATICA

Descrizione

Dimensione: 10"/250mm



Specifiche tecniche

Codice INECO	Codice Total	Diametro taglio (mm)	Prezzo
4361200250	THT171102	14-40	25.50 €

UTENSILI PER IDRAULICO



Nome / Famiglia

43610

TAGLIATUBI PER TUBI IN METALLO

Descrizione

Taglia tubi per tubi in rame e lega leggera, con lama di alta qualità e pomello in alluminio

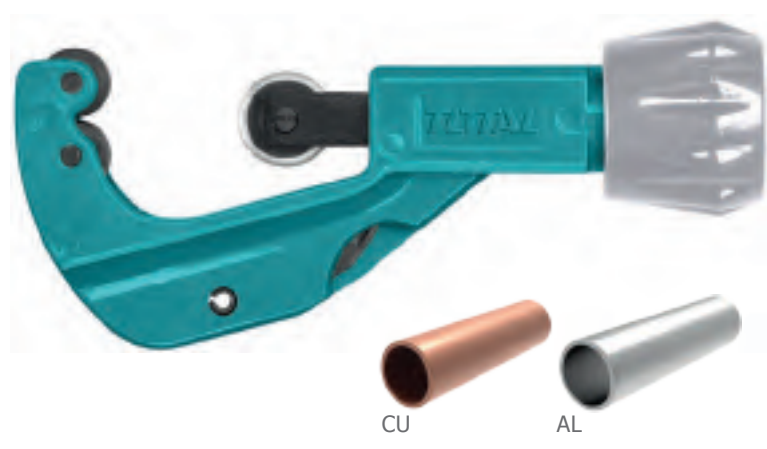
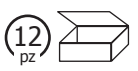

Packaging



Specifiche tecniche

Codice INECO	Codice Total	Diametro taglio (mm)	Prezzo
4361003032	THT53321	3-32	10.50 €

Nome / Famiglia

43608

TAGLIATUBI PER TUBI IN PLASTICA

Descrizione

Taglia tubi per tubi e profilati in plastica, corpo in alluminio

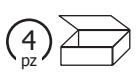

Packaging



Specifiche tecniche

Codice INECO	Codice Total	L(mm)	Ø Taglio	Prezzo
4360803042	THT53422	225	3-42 mm	16.45 €

PORTA UTENSILI

447/448

Tessuto in
poliestere 600D
ultra resistente
ed anti
umidità

Robusto **manico**
in acciaio
con impugnatura
ergonomica



Fondo **rigido**

14 tasche
e tracolla

44714

**CESTELLO
RICHIUDIBILE**

PORTA UTENSILI

INDUSTRIAL TOTAL

Nome / Famiglia

44730

CASSETTA PORTA UTENSILI

Descrizione

Cassetta porta utensili in polipropilene con ampia capacità di carico

Caratt.

14" 17" 20"**1**
pz 

Specifiche tecniche

Codice INECO	Codice Total	Misura	Portata max	Dimensioni (mm)	Prezzo
4473000014	TPBX0142	14"	10 kg	356x168x160	13.15 €
4473000017	TPBX0172	17"	15 kg	436x220x205	21.00 €
4473000020	TPBX0202	20"	20 kg	508x296x261	34.30 €

Nome / Famiglia

44732

SET DI 3 CASSETTE PORTA UTENSILI

Caratt.

14" 17" 20"**1**
pz 

Specifiche tecniche

Codice INECO	Codice Total	Prezzo
4473200003	TPBXK0032	68.00 €

PORTA UTENSILI



44810

CASSETTA PORTA ATTREZZI IN METALLO

Nome / Famiglia

Descrizione

Cassetta estensibile in metallo a 5 scomparti



Specifiche tecniche

Codice INECO	Codice Total	Misure _{mm}	Sp. Acciaio	Prezzo
4481000001	THT10701	495x200x290	0.6~0.8 mm	72.50 €

44716

TROLLEY PORTA UTENSILI

Nome / Famiglia

Descrizione

Trolley porta attrezzi in poliestere 600D, telaio rigido con maniglia telescopica, 5 tasche esterne e numerose tasche interne

Caratt.

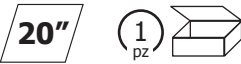

Specifiche tecniche

Codice INECO	Codice Total	Misura	Portata max	Prezzo
4471600020	THRRTB2001	20"	20 kg	96.50 €

PORTA UTENSILI

INDUSTRIAL TOTAL

Nome / Famiglia

44712

BAULETTO PORTA UTENSILI

Descrizione

Borsa porta attrezzi in poliestere 600D, 25 tasche porta utensili ed altre tasche interne, tracolla regolabile, fondo rigido

Caratt.

16"



Specifiche tecniche

Codice INECO	Codice Total	Misura	Portata max	Prezzo
4471200016	THT56161	16"	20 kg	50.00 €

Nome / Famiglia

44714

CESTELLO RICHIUDIBILE

Descrizione

Borsa porta attrezzi in poliestere 600D e materiale anti-umidità, apertura su due lati, manico in acciaio con impugnatura ergonomica e tracolla, fondo rigido

Caratt.

16"



Specifiche tecniche

Codice INECO	Codice Total	Misura	Portata max	Prezzo
4471400016	THT66L01	16"	20 kg	68.00 €

PORTA UTENSILI



Nome / Famiglia

44710

CESTELLO CON TRACCOLLA

Descrizione

Borsa porta attrezzi in poliestere 600D, manico in acciaio con impugnatura ergonomica e tracolla, fondo rigido

Caratt.



Specifiche tecniche

Codice INECO	Codice Total	Misura	Portata max	Prezzo
4471000016	THT36L01	16"	20 kg	59.50 €



Nome / Famiglia

44708

BORSA PORTA UTENSILI CON FONDO E TELAIO RIGIDI

Descrizione

Borsa porta attrezzi, con tasche interne ed esterne per ulteriore capacità, telaio e fondo rigidi, tracolla regolabile

Caratt.



Specifiche tecniche

Codice INECO	Codice Total	Misura	Portata max	Prezzo
4470800016	THT16162	16"	20 kg	35.50 €
4470800024	THT16241	24"	25 kg	65.50 €



PORTA UTENSILI

INDUSTRIAL TOTAL

Nome / Famiglia

44706

BORSA PORTA UTENSILI 16" CON FONDO RIGIDO

Descrizione

Borsa porta utensili da 16", fondo rigido,
tracolla regolabile, tasche interne per ulteriore capacità

Caratt.

16"**5**
pz

Specifiche tecniche

Codice INECO	Codice Total	Misura	Portata max	Prezzo
4470600016	THT16161	16"	20 kg	50.00 €

Nome / Famiglia

44704

BORSA PORTA UTENSILI

Descrizione

Borsa porta utensili, telaio rigido, 6 tasche esterne
ed altre interne per ulteriore capacità

Caratt.

13"**20**
pz

Specifiche tecniche

Codice INECO	Codice Total	Misura	Portata max	Prezzo
4470400013	THT261325	13"	12 kg	10.00 €
4481200001	THT26161	16"	12 kg	19.00 €

PORTA UTENSILI



Nome / Famiglia

44724

ZAINO PORTA UTENSILI

Descrizione

Zaino porta attrezzi, in poliestere oxford 600D, con borsa interna, telaio rigido e tasche esterne



Specifiche tecniche

Codice INECO	Codice Total	Misura	Portata max	Prezzo
4472400001	THBP0201	34x17x43 cm	20 kg	41.00 €

Nome / Famiglia

44726

GILET PORTA UTENSILI

Descrizione

Gilet porta attrezzi, con spallacci e girovita regolabili, tessuto a maglia d'aria, 12 tasche e 1 porta martello

Caratt.



Specifiche tecniche

Codice INECO	Codice Total	Misura	Portata max	Prezzo
4472600001	TTVT1601	42x60x3 cm	3 kg	31.80 €

PORTA UTENSILI



44718

FODERA PORTA UTENSILI 4 TASCHE

Nome / Famiglia

Descrizione
 Fodera porta attrezzi in poliestere 600D, 4 tasche



Specifiche tecniche

Codice INECO	Codice Total	Misura	Portata max	Prezzo
4471800001	THT16P4011	24x13 cm	5 kg	4.46 €

44720

FODERA PORTA TRAPANO CON CINTURA

Nome / Famiglia

Descrizione
 Fodera porta trapano in poliestere 600D, 1 tasca porta avvitatore, 5 tasche porta utensili, con cintura



Specifiche tecniche

Codice INECO	Codice Total	Misura	Portata max	Prezzo
4472000001	THT16P3011	32x19 cm	8 kg	7.26 €

44722

FODERA PORTA UTENSILI 10 TASCHE

Nome / Famiglia

Descrizione
 Fodera porta attrezzi in poliestere 600D, portata massima 10 kg, 10 tasche, 2 porta martelli, altre tasche porta utensili



Specifiche tecniche

Codice INECO	Codice Total	Misura	Portata max	Prezzo
4472200001	THT16P1011	32x28 cm	10 kg	17.10 €

44808

CINTURA PORTA ATTREZZI

Nome / Famiglia

Descrizione
 Cintura porta attrezzi doppia in tessuto rinforzato ad alta resistenza, 14 tasche, due porta martelli



Specifiche tecniche

Codice INECO	Codice Total	Specifiche	Prezzo
4480800001	THT16P2031	2pz. 26x23cm	25.30 €
		1pz. 15x13cm	
		Cint. regolabile (92-127cm)	
		14 tasche	
		2 porta martello	

SET DI UTENSILI E CARRELLI

424

Piano di lavoro
in **ABS**
ad alta
resistenza
con maniglie
integrate

Pannelli
laterali forati
con ganci
universali in
dotazione

Chiusura centralizzata

Pratica **indicazione**
del contenuto dei cassetti

Cassetti ad **estrazione totale** montati
su guide telescopiche a sfera con
dispositivo di blocco



42414

CARRELLO
PORTAUTENSILI
7 CASSETTI CON
162 UTENSILI

SET DI UTENSILI E CARRELLI



42410

ASSORTIMENTO 59 PEZZI UTENSILI MANUALI IN CASSETTA ESTENSIBILE

Set 59 pezzi utensili manuali in cassetta estensibile in metallo 5 scomparti



Composta da:

- 12 chiavi combinate: 8-10-11-12-13-14-15-16-17-18-19-22mm
- 8 giraviti per viti con intaglio e con impronta a croce Phillips™: SL3X75mm, 4x100mm, 5x125mm, 6x100mm, 8x200mm
- PH1X80mm, PH2X100mm, PH3X200mm
- 18 bussole esagonali 1/2": 8-10-12-13-14-15-16-17-18-19-20-21-22-23-24-27-30-32mm
- 1 cricchetto 1/2", 45T
- 2 prolunghe 1/2": 125mm(5"), 250mm(10")
- 2 bussole 1/2" per candele 16mm&21mm
- 1 adattatore universale 1/2"
- 1 prolunga flessibile 1/2", 375mm
- 1 pinza universale 200 mm
- 1 pinza a becchi lunghi 160 mm
- 1 tronchese diagonale 180 mm
- 1 pinza regolabile 250 mm
- 1 pinza a scatto
- 9 chiavi maschio esagonali 1.5-2-2.5-3-4-5-6-8-10mm

In acciaio al Cr-V, in valigetta metallica 5 scomparti

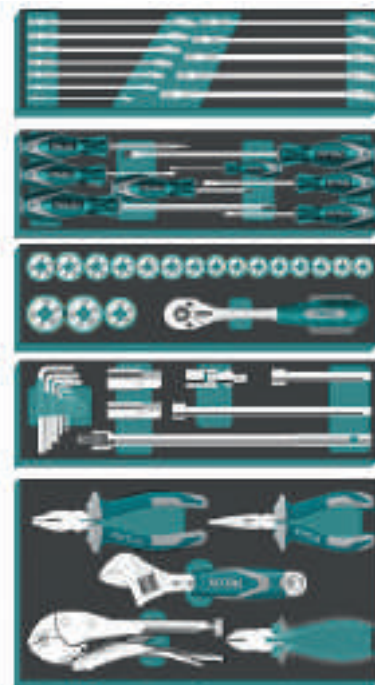

Specifiche tecniche



Codice INECO	Codice Total	Pezzi	Box Misura (cm)	Prezzo
4241000059	THTCS12591	142	460x260x22	340.00 €

SET DI UTENSILI E CARRELLI



Nome / Famiglia

42410

ASSORTIMENTO 142 PEZZI UTENSILI MANUALI

Descrizione

Set 142 pezzi utensili manuali in valigetta ABS ad alta resistenza



Utensili attacco 1/2"

- 19 bussole 1/2": 8-10-12-13-14-15-16-17-18-19-20-21-22-23-24-25-27-30-32mm
- 5 bussole 1/2" per impronta Torx™: E10 12 14 16 20
- 1 prolunga snodata 1/2" x 375mm
- 1 cricchetto 1/2", 45T
- 2 prolunghe 1/2" da 75mm(3") e 250mm(10")
- 1 snodo 1/2"
- 1 adattatore a tre vie 1/2"(F)x3/8"(M)
- 2 bussole per A1: Y293 1/2" da 16mm&21mm
- 1 prolunga a L 1/2"x10"

Utensili attacco 3/8"

- 15 bussole da 3/8" : 6-7-8-9-10-11-12-13-14-15-17-18-19-21-22
- 1 cricchetto 3/8", 45T
- 2 prolunghe 3/8": 75mm(3") 150mm(6")
- 1 snodo 3/8"

Utensili attacco 1/4":

- 26 inserti 1/4"x25mm con impronte assortite: PH0-PH1-PH2-PH3-PZ0-PZ1-PZ2-PZ3-SL4-SL5.5-SL7 H2-H3-H4-H5-H6-H7-H8-H10, T10H-T15H-T20H-T25H-T27H-T30H-T40H
- 1 giravite porta inserti
- 9 bussole 1/4": 4-4.5-5-5.5-6-7-8-9-10
- 5 bussole 1/4" per impronta Torx™: E4 5 6 7 8
- 1 cricchetto 1/4", 45T
- 3 prolunghe 1/4": 50mm(2") 100mm(4") 150mm(6")
- 1 snodo 1/4"
- 1 adattatore a tre vie 3/8"(F)x1/4"(M)
- 1 prolunga 1/4"x150mm
- 1 prolunga flessibile 1/4"x150mm

Altri utensili:

- 17 chiavi combinate: 6-7-8-9-10-11-12-13-14-15-16-17-18-19-21-22-24
- 5 chiavi per raccordi: 8x10-10x12-11x13-12x14-17x19
- 10 chiavi maschio esagonali: 2.5-3-4-5-6-7-8-10-12-14mm
- 1 martello tipo tedesco da 300g
- 1 pinza universale 180mm
- 1 pinza autobloccante 10"
- 2 giraviti per viti con intaglio: SL6.5x100 SL6.5x150
- 2 giraviti per viti con impronta a stella Phillips™: PH2x100 PH2x150
- 2 giraviti corti: PH2x38 SL6.5x38

In acciaio al Cr-V, in valigetta ABS



Specifiche tecniche



Codice INECO	Codice Total	Pezzi	Box Misura (cm)	Prezzo
42410000142	THKTHP21426	142	460x260x22	334.00 €

SET DI UTENSILI E CARRELLI

INDUSTRIAL TOTAL

Nome / Famiglia

42412

SET 25 PEZZI UTENSILI MANUALI

Descrizione

Set 25 pezzi utensili manuali in valigetta ABS



Utensili:

- 1 pinza universale
- 1 tronchese
- 1 chiave a rullino
- 1 flessometro
- 1 manico ergonomico con 20 inserti



Specifiche tecniche



Codice INECO	Codice Total	Pezzi	Prezzo
4241200025	THKTHP90256	25	48.10 €

SET DI UTENSILI E CARRELLI



Nome / Famiglia

42414

CARRELLO PORTAUTENSILI 7 CASSETTI CON 162 UTENSILI

Descrizione

Carrello portautensili 7 cassetti, con 162 utensili manuali assortiti



Caratteristiche carrello

- 7 cassetti
- Dimensioni: 765x465x812mm
- Dimensioni con ruote: 765x465x976mm
- Dimensioni ruote: 127mm x 50mm
- Spessore della lamiera: 0.8-1.0mm
- Spessore lamiera cassetti: 0.7mm
- 5 cassetti dimensione 536x410x74.5mm
- 2 cassetti dimensione 536x410x153.5mm

Confezionato in schiuma EVA + scatola di cartone + Pallet

Specifiche tecniche



Codice INECO	Codice Total	Pezzi	Prezzo
4241470162	THPTCS71621	162	1.100.00 €

SET DI UTENSILI E CARRELLI

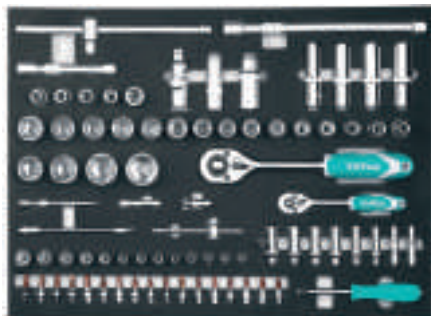

Cassetto 1

- 1 cricchetto 1/4"
- 13 bussole 1/4" 4-4.5-5-5.5-6-7-8-9-10-11-12-13-14
- 17 bussole 1/4" x 32(L) per viti con impronte assortite:
Hex:3-4-5-6mm
Torx™: T8-T10-T15-T20-T25-T30
SL: 4-5.5-7mm, PH1, PH2, PZ1, PZ2
- 8 bussole 1/4" 50mm: 6-7-8-9-10-11-12-13mm
- 2 prolunghe: 1/4" x 50mm, 1/4" x 100mm
- 1 giravite porta bussole 1/4" x 150mm
- 1 prolunga flessibile 1/4" x 150mm
- 1 snodo 1/4"
- 1 prolunga a "T" 1/4" x 114mm
- 1 cricchetto 1/2"
- 1 snodo 1/2"
- 19 bussole 1/2": 8-10-11-12-13-14-15-16-17-18-19-20-21-22-23-24-27-30-32mm
- 4 bussole 1/2" x77mm: 14-15-17-19mm
- 5 bussole 1/2" per impronta Torx™: E10 12 14 16 20
- 2 bussole per candele: 1/2"Dr.16mm -21mm
- 1 prolunga a T 1/2"x250mm
- 2 prolunghe 1/2" x 125mm, 1/2" x 250mm



Cassetto 3

- 17 chiavi combinate: 6-7-8-9-10-11-12-13-14-15-16-17-18-19-21-22-24
- 5 chiavi per raccordi: 8x10,10x12,11x13,12x14,17x19
- 9 chiavi maschio esagonali: 1.5-2-2.5-3-4-5-6-8-10
- 9 chiavi maschio per viti con impronta Torx™: T10-T15-T20-T25-T27-T30-T40-T45-T50



Cassetto 4

- 1 pinza a scatto
- 1 martello con testa in gomma e plastica
- 1 pinza regolabile per idraulici 250 mm
- 1 pinza universale 200 mm
- 1 pinza a becchi lunghi 160 mm
- 1 tronchese diagonale 180 mm
- 1 coltellino multifunzione
- 4 pinze per anelli
- 1 martello tipo tedesco 300 g
- 1 pinza regolabile 250 mm
- 1 flessometro 5x19 mm

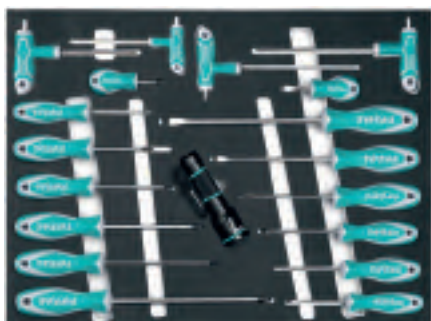

Cassetto 2

- 14 giraviti impronte assortite: SL3x75, SL4x100, SL5.5x100, SL6.5x38, SL6.5x125, SL6.5x150, SL8x200, PH0x75, PH1x75, PH1x100, PH2x38, PH2x125, PH2x150, PH3x200
- 4 chiavi maschio esagonali impugnatura a T:
- wrench: 3x100mm, 4x100mm, 5x150mm, 6x150mm
- 1 torcia led



Cassetto 5

- 1 livella a bolla magnetica
- 1 seghetto per ferro
- 1 paio di guanti da officina
- 5 ganci universali per appendere gli utensili sulle griglie laterali del carrello

Cassetto 6 (Vuoto)

Cassetto 7 (Vuoto)

SET DI UTENSILI E CARRELLI



42418

CARRELLO PORTAUTENSILI VUOTO CON 7 CASSETTI

Nome / Famiglia

Descrizione

7 cassetti
 Dimensioni: 765x465x812mm
 Dimensioni con ruote: 765x465x976mm
 Dimensioni ruote: 127mm x 50mm
 Spessore della lamiera: 0.8-1.0mm
 Spessore lamiera cassetti: 0.7mm
 5 cassetti dimensione 536x410x74.5mm
 2 cassetti dimensione 536x410x153.5mm

Confezionato in schiuma EVA + scatola di cartone + Pallet



Specifiche tecniche

Codice INECO	Codice Total	Caratteristiche	Prezzo
4241800000	THRC01071	7 cassetti vuoti	612.00 €

42420

CARRELLO PORTAUTENSILI VUOTO CON 7 CASSETTI - EASY

Nome / Famiglia



Easy

Specifiche tecniche

Codice INECO	Codice Total	Prezzo
4242070001	THRC02071P	560.00 €

SET DI UTENSILI E CARRELLI



42422

CARRELLO PORTAUTENSILI VUOTO CON 4 CASSETTI + ANTINE

Nome / Famiglia



Specifiche tecniche

Codice INECO	Codice Total	Prezzo
4242240001	THRC01041	536.00 €

42426

CARRELLO 2 CASSETTI

Nome / Famiglia

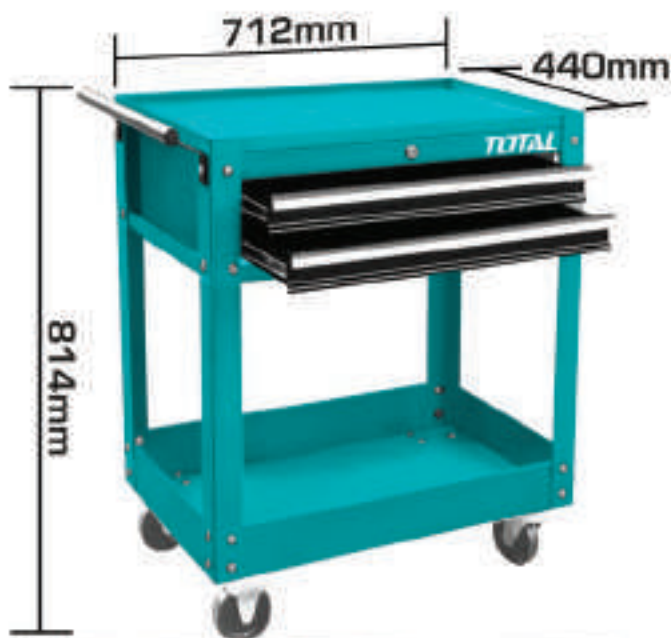

Specifiche tecniche

Codice INECO	Codice Total	Prezzo
4242620001	THPTC201	260.00 €

SET DI UTENSILI E CARRELLI



Nome / Famiglia

42424

CARRELLO 3 RIPIANI

Descrizione

Carrello a 3 ripiani con ruote piroettanti



Specifiche tecniche

Codice INECO	Codice Total	Prezzo
4242430001	THPTC301	120.00 €



GIARDINAGGIO

480/482



GIARDINAGGIO

INDUSTRIAL TOTAL

Nome / Famiglia

48258

**MOTOSEGA A BATTERIA 20V,
MOTORE BRUSHLESS, CORPO MACCHINA**



Motore brushless
Tensione della batteria: 20V
Potenza massima: 900W
Velocità della catena: 3700-4500 rpm
Lunghezza della barra: 12"
Passo della catena: 3/8"
Batteria e caricatore: non inclusi

*Catena e barra di ricambio a pagina 55



Specifiche tecniche

Codice INECO	Codice Total	Prezzo
4825800020	TGSLI20128	265.00 €

Nome / Famiglia

48255

**CESOIA A BATTERIA 20V,
MOTORE BRUSHLESS, CORPO MACCHINA**



Motore brushless
Tensione della batteria: 20 V
Diametro di taglio: 20 mm - 30 mm
Batteria e caricatore: non inclusi



Specifiche tecniche

Codice INECO	Codice Total	Prezzo
4825500020	TSSLI20308	209.00 €

GIARDINAGGIO

INDUSTRIAL TOTAL

48256

**DECESPUGLIATORE A BATTERIA 40V,
MOTORE BRUSHLES, CORPO MACCHINA**



Motore brushless

Tensione della batteria: 40 V

Velocità max: 0-5500/min 0-6500/min

Diametro della lama: 255 mm

Diametro rifinitore a filo: 330 mm

Batteria e caricatore: non inclusi

Diametro filo: 2,0 mm tondo

Lunghezza totale filo: 5,0 m

Lama a 3 denti: inclusa

Rifinitore a filo: incluso

Bobina di ricambio disponibile su richiesta
(codice INECO 4862200001)



Specifiche tecniche

Codice INECO	Codice Total	Prezzo
4825600040	TSTLI20028	289.00 €

47052

**TAGLIABORDI 20 V,
CORPO MACCHINA**



Tensione della batteria: 20V

Velocità max: 7800/min

Lunghezza di taglio: 300mm

Diametro filo: 1.6mm twisted

Lunghezza totale filo: 5m

Batteria e caricatore: non inclusi

Bobina di ricambio disponibile su richiesta
(codice INECO 4862400001)



Specifiche tecniche

Codice INECO	Codice Total	Prezzo
4705200001	TGTLI20018	99.00 €

GIARDINAGGIO

INDUSTRIAL TOTAL

Nome / Famiglia

47054**TAGLIA SIEPI 20 V, CORPO MACCHINA**

Tensione della batteria: 20V
Velocità massima: 1400rpm
Lunghezza di taglio: 18"
Distanza denti: 18mm
Batteria e caricatore: non inclusi



Specifiche tecniche

Codice INECO	Codice Total	Prezzo
4705400001	THTLI20018	121.00 €

Nome / Famiglia

48202**SOFFIATORE 20V BRUSHLESS, CORPO MACCHINA**

Motore Brushless
Tensione della batteria: 20 V
Velocità massima: 15000 rpm
Portata d'aria: 8,5 m³/min
Velocità dell'aria massima: 42 m/s
Batteria e caricatore: non inclusi



Specifiche tecniche

Codice INECO	Codice Total	Prezzo
4820200020	TABLI20428	126.00 €

Nome / Famiglia

48204**IDROPULTRICE 20V, CORPO MACCHINA**

Tensione della batteria: 20 V
Pressione massima: 24,8 bar
Portata: 132 l/h
Sistema di autobloccaggio
Inclusi:
 6 diverse modalità di spruzzo
 1 tubo di ingresso dell'acqua da 6 m con connettore rapido
 1 connettore autoaspirante
 1 schiumogeno da 400 ml
 1 borsa portatile
Batteria e caricatore: non inclusi



Specifiche tecniche

Codice INECO	Codice Total	Prezzo
4820400020	TPWLI2008	117.50 €



GIARDINAGGIO

INDUSTRIAL TOTAL

Nome / Famiglia

48206**IDROPULTRICE
130 BAR****Pressione massima:** 130 bar**Potenza assorbita:** 1400W**Tensione:** 220-240V~50/60Hz**Portata:** 330 l/h**Sistema di auto-bloccaggio****Inclusi:**

1 pistola

1 tubo ad alta pressione da 5 m



Specifiche tecniche

Codice INECO	Codice Total	Prezzo
4820600130	TGT11316	161.50 €



Nome / Famiglia

48207**IDROPULTRICE
150 BAR****Pressione massima:** 150 bar**Potenza assorbita:** 1800W**Tensione:** 220-240V~50/60Hz**Portata:** 360 l/h**Sistema di auto-bloccaggio****Inclusi:**

1 bottiglia di sapone

1 pistola

1 tubo ad alta pressione da 5 m



Specifiche tecniche

Codice INECO	Codice Total	Prezzo
4820700150	TGT11356	245.00 €



GIARDINAGGIO

INDUSTRIAL TOTAL

Nome / Famiglia

48602

PISTOLA PER IDROPULTRICE CON ATTACCO RAPIDO



Compatibile con idropultrici
Total TGT11316 e TGT11356
e universali



Specifiche tecniche

Codice INECO	Codice Total	Prezzo
4860200001	TGTSG026	37.50 €



Nome / Famiglia

48604

SPAZZOLA PER IDROPULTRICE



Misure: 270x95 mm
Compatibile con pistola per
idropultrice TGTSG026 e universali



Specifiche tecniche

Codice INECO	Codice Total	Prezzo
4860400001	TGTHB2791	23.20 €

Nome / Famiglia

48606

LAVAPAVIMENTI



Diametro: 250mm
Braccio di estensione: 455mm
Compatibile con pistola per
idropultrice TGTSG026 e universali



Specifiche tecniche

Codice INECO	Codice Total	Prezzo
4860600001	TGTPB251	31.00 €

Nome / Famiglia

48608

SCHIUMOGENO PER IDROPULITRICE



Capacità: 400ml
 Con regolatore
 Compatibile con pistola per idropulitrice TGTS026 e universali



Specifiche tecniche

Codice INECO	Codice Total	Prezzo
4860800001	TMFP402	11.00 €

Nome / Famiglia

48616

SPAZZOLA LAVACERCHI



Compatibile con pistola per idropulitrice TGTS026 e universali



Specifiche tecniche

Codice INECO	Codice Total	Prezzo
4861600001	TGTWB1781	13.95 €

Nome / Famiglia

48610

TUBO AD ALTA PRESSIONE



Lunghezza: 5m
Materiale: PVC
 Compatibile con idropultrici Total TGT11316 e TGT11356 e universali



Specifiche tecniche

Codice INECO	Codice Total	Prezzo
4861000001	TGTHPH526	23.80 €

Nome / Famiglia

48612

SONDA SPURGATUBI



Lunghezza: 7,5 m
Pressione massima: 150 bar
 Con testa a molla
 Compatibile con idropultrici Total TGT11316 e TGT11356 e idropultrici universali



7.5m Max pressure: 150bar

Specifiche tecniche

Codice INECO	Codice Total	Prezzo
4861200001	TGTPCH751	30.50 €

GIARDINAGGIO

INDUSTRIAL TOTAL

Nome / Famiglia

48006**FORBICI DA POTATURA**

Descrizione

Forbici da potatura con lama in acciaio al carbonio, intera struttura in metallo con impugnatura ergonomica bimatériale

Caratt.

PP
HandleSoft
TPRMAX
Ø16mm12
pz

Packaging



Specifiche tecniche

Codice INECO	Codice Total	Lunghezza (mm)	Prezzo
4800600220	THT0601	220	10.35 €

Nome / Famiglia

48005**FORBICI DA POTATURA
SUPER SELECT**

Descrizione

Forbici da potatura con lama in acciaio al carbonio, intera struttura in metallo con impugnatura in PP

Caratt.

Heat
treatmentTeflon
TreatmentMAX
Ø12mm12
pz

Packaging



Specifiche tecniche

Codice INECO	Codice Total	Lunghezza (mm)	Prezzo
4800500200	THT0201	200	7.24 €

Nome / Famiglia

48007**FORBICI DA POTATURA
MANICO IN ALLUMINIO**

Descrizione

Forbici da potatura con lama di qualità superiore, struttura in alluminio con impugnatura ergonomica

Caratt.

AL
HandleSoft
TPRMAX
Ø15mm12
pz

Packaging



Specifiche tecniche

Codice INECO	Codice Total	Lunghezza (mm)	Prezzo
4800700205	THT15308	205	14.80 €

48008**CESOIA TAGLIASIEPI**

Nome / Famiglia

Descrizione

Cesoia tagliasiepi, in acciaio al carbonio,
lama temperata rivestita in Teflon

Caratt.



Specifiche tecniche

Codice INECO	Codice Total	Lunghezza (mm)	Prezzo
4800800580	THT1516001	580	20.90 €

Packaging

**48010****CESOIA TAGLIASIEPI
CON REGOLATORE DI TENSIONE**

Nome / Famiglia

Descrizione

Cesoia tagliasiepi, in acciaio al carbonio, tensione della
lama regolabile, lama temperata rivestita in Teflon

Caratt.



Specifiche tecniche

Codice INECO	Codice Total	Lunghezza (mm)	Prezzo
4801000580	THT1516301	580	23.30 €

Packaging



48012**CESOIA TAGLIASIEPI TELESCOPICA**

Nome / Famiglia

Descrizione

Cesoia tagliaiepi con manico telescopico, in acciaio al carbonio, tensione della lama regolabile, lama temperata rivestita in Teflon

Caratt.



Packaging



Specifiche tecniche

Codice INECO	Codice Total	Lunghezza (mm)	Prezzo
4801200001	THTS1516306	710-860	34.00 €

48014**TRONCARAMI**

Nome / Famiglia

Descrizione

Troncarami in acciaio al carbonio, massimo diametro di taglio 25 mm, lama temperata rivestita in Teflon

Caratt.



Packaging



Specifiche tecniche

Codice INECO	Codice Total	Lunghezza (mm)	Prezzo
4801400760	THT1527401	760	28.10 €

GIARDINAGGIO

INDUSTRIAL TOTAL

48020

SVETTATOIO TELESCOPICO

Nome / Famiglia

Descrizione

Svettatoio telescopico troncaremi, lama in acciaio SK5 con tripla dentatura, rivestita in teflon

Caratt.



Estensione massima: 2800 mm
Diametro massimo di taglio: 25 mm



Specifiche tecniche

Codice INECO	Codice Total	Prezzo
4802000001	THEPS25281	43.20 €

48016

SET 3 CESCOIE DA POTATURA

Nome / Famiglia

Descrizione

Troncaremi in acciaio al carbonio, massimo diametro di taglio 25 mm, lama temperata rivestita in Teflon

Caratt.



Composto da:
 1 forbice da potatura
 1 cesoia tagliasiepi
 1 troncaremi



Packaging



Specifiche tecniche

Codice INECO	Codice Total	Prezzo
4801600001	THT1576033	48.50 €

GIARDINAGGIO

INDUSTRIAL TOTAL

Nome / Famiglia

48002**ASCIA**

Descrizione

Testa in acciaio al carbonio, manico in fibra di vetro con impugnatura ergonomica bimatériale

6
pz



Specifiche tecniche

Codice INECO	Codice Total	Peso (g)	Prezzo
4800200600	THT786006	600	14.95 €
4800201000	THT7810006	1000	20.00 €
4800201250	THT7812506	1250	31.50 €

Nome / Famiglia

48004**ASCIA
SPACCALEGNA**

Descrizione

Ascia spaccalegna, peso 2.7kg, testa forgiata a caldo in acciaio al carbonio, impugnatura ergonomica in fibra di vetro

1
pz



Specifiche tecniche

Codice INECO	Codice Total	Peso (g)	Prezzo
4800402700	THT78206D	2700	41.30 €

GIARDINAGGIO



48018

SEGHETTO AD ARCO PER LEGNO

Nome / Famiglia

Descrizione
 Seghetto ad arco per legno, lama inclusa



Specifiche tecniche

Codice INECO	Codice Total	Lunghezza (mm)	Prezzo
4801800610	THT59241	610 (24")	12.85 €

43010

SEGHETTO PER LEGNO A SERRAMANICO

Nome / Famiglia

Descrizione
 Seghetto per legno a serramanico con impugnatura ergonomica bimatériale, lama in acciaio alta qualità SK5, denti temprati 7 TPI, tripla affilatura della lama.



Specifiche tecniche

Codice INECO	Codice Total	Lunghezza (mm)	Prezzo
4301000180	THFSW1806	180	11.40 €

43010

SEGHETTO PER POTATURA

Nome / Famiglia

Descrizione
 Seghetto per potatura con impugnatura ergonomica bimatériale, lama in acciaio alta qualità SK5, denti temprati 7 TPI



Specifiche tecniche

Codice INECO	Codice Total	Lunghezza (mm)	Prezzo
4301000330	THT5113306	330	14.55 €

GIARDINAGGIO

INDUSTRIAL TOTAL

Nome / Famiglia

48022**TRAPIANTATORE**

Descrizione

Trapiantatore da giardinaggio in acciaio al carbonio

Caratt.



Lunghezza: 340 mm
Larghezza: 85 mm
Spessore: 1,5 mm



Specifiche tecniche

Codice INECO	Codice Total	Prezzo
4802200340	THFTT858	5.58 €

Nome / Famiglia

48026**ZAPPETTA**

Descrizione

Zappetta da giardinaggio in acciaio al carbonio

Caratt.



Lunghezza: 290 mm
Larghezza: 75 mm



Specifiche tecniche

Codice INECO	Codice Total	Prezzo
4802600290	THGT979K	5.58 €

Nome / Famiglia

48024**RASTRELLO**

Descrizione

Rastrello da giardinaggio in acciaio al carbonio

Caratt.



Lunghezza: 270 mm
Larghezza: 82 mm



Specifiche tecniche

Codice INECO	Codice Total	Prezzo
4802400270	THFTR1008	5.58 €

TOTAL

One-Stop Tools Station

MERCHANDISING



Nome / Famiglia

45402**GONDOLA**

Specifiche tecniche

Codice INECO	Codice Total	Dimensioni
4540200220	PMST02	95x38x220cm

Nome / Famiglia

45404**CAPPELLINI**

Specifiche tecniche

Codice INECO	Codice Total
4540400001	PMCA04

Nome / Famiglia

45406**T-SHIRT**

Specifiche tecniche

Codice INECO	Codice Total
4540600001	PMTS10.M
4540600002	PMTS10.L
4540600003	PMTS10.XL

TOTAL
One-Stop Tools Station

TOTAL
One-Stop Tools Station

TOTAL
One-Stop Tools Station

TOTAL
One-Stop Tools Station



ALLESTIMENTI ED ESPOSITORI SU MISURA

Sistema modulare «ad isola».

Ideale per l'esposizione dei prodotti in assenza di spazio a parete; l'altezza max di 150 cm lo rende lo strumento ideale per la creazione di aree dedicate anche al centro del locale, senza che venga nascosta la visuale. Elegante e discreta finitura nero opaco.

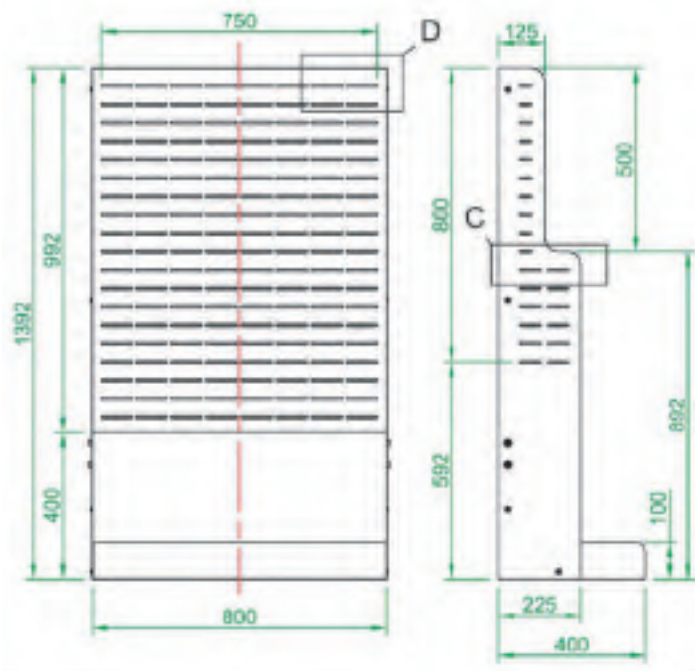

Sistema componibile con 1, 2 o 3 elementi in base alle proprie esigenze ed allo spazio disponibile, con ripiani removibili per la massima flessibilità e personalizzazione.

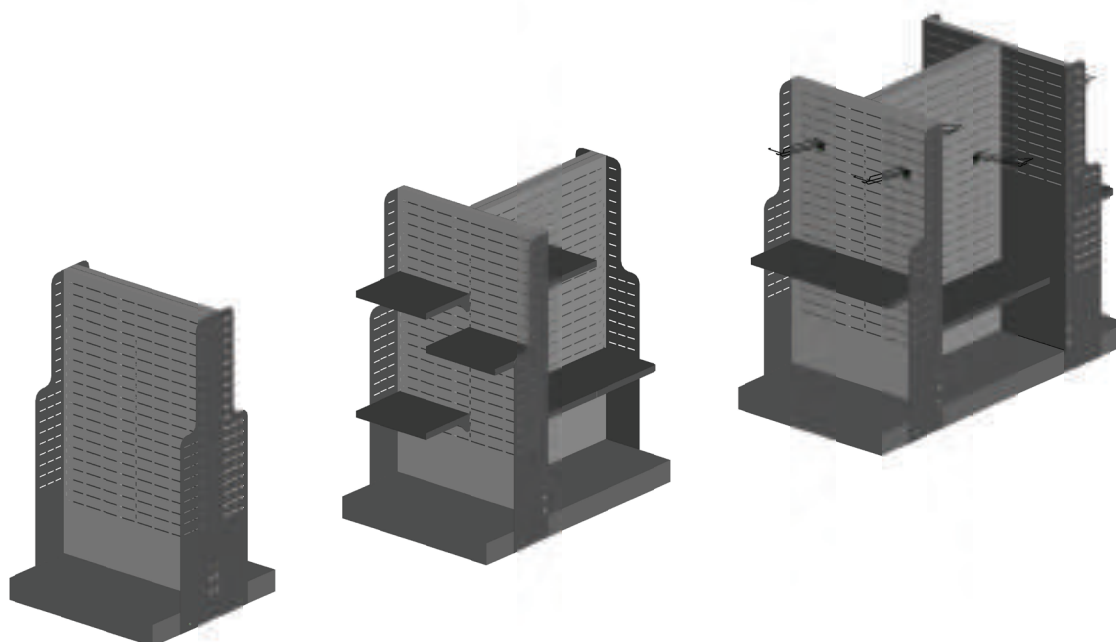

Sistema espositivo a parete.

Ideale per l'esposizione di prodotti lungo il perimetro del locale, sono disponibili esempi di allestimenti con proposte di assortimenti ottimizzati in base allo spazio disponibile.

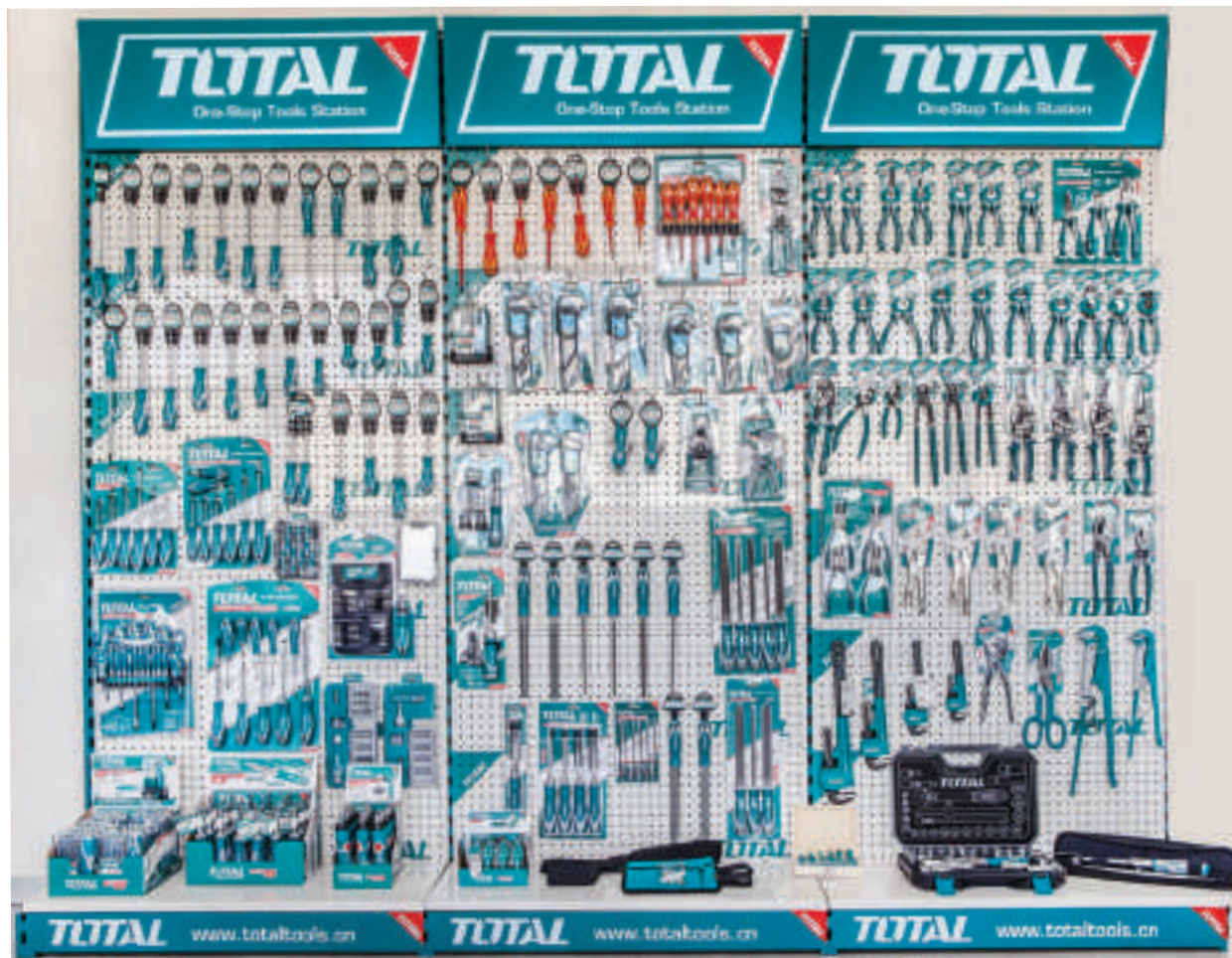

GLI ORDINI SONO ASSUNTI ESCLUSIVAMENTE ALLE SEGUENTI CONDIZIONI:

ACQUISIZIONE DI ORDINI

L'acquisizione di un ordine non impegna la INECO SRL alla quale spetta la decisione di evasione.

PREZZI

I prezzi si intendono per merce resa franco ns. magazzini (imballo, I.V.A., trasporto, installazione e/o corsi di formazione esclusi) e non sono impegnativi. Avrà comunque valore in ogni caso il prezzo in vigore al momento della spedizione. Non si accettano ordini inferiori a 100 €. Foto, descrizioni, dati tecnici e prezzi, non sono vincolanti - Salvo errori ed omissioni - Ci riserviamo il diritto di apportare ogni modifica senza preavviso.

SPEDIZIONI

Salvo precise disposizioni del committente, le spedizioni verranno eseguite nel modo che la INECO SRL riterrà più opportuno senza alcuna sua responsabilità. La merce viaggia a rischio e pericolo del committente. In caso di ritardo, avaria, ammanco che si dovesse verificare durante il trasporto, i reclami dovranno essere indirizzati al vettore unico responsabile.

CONSEGNE

Il termine di consegna, se fissato, ha valore indicativo ed un eventuale ritardo non pregiudica in ogni caso la validità dell'ordine.

PAGAMENTI

I pagamenti dovranno essere effettuati esclusivamente alla ns. Sede. Trattenute arbitrarie ed arrotondamenti, non saranno ammessi per nessuna ragione. Sconti concessi al pagamento condizionato, precedentemente concordati, dovranno essere calcolati sull'importo della merce, escludendo I.V.A. imballo e le eventuali spese di trasporto. I pagamenti non conformi alle condizioni pattuite saranno respinti. La consegna della merce non trasferisce la proprietà della stessa se non a pagamento integrale avvenuto. In caso di ritardo nei pagamenti, secondo le condizioni pattuite potranno essere sospese le spedizioni ed annullati gli ordini senz'obbligo di comunicazione al committente.

INSOLVENZA

In caso di protesto di tratte con godimento dello sconto per pronta cassa, detto sconto verrà recuperato e la fattura dovrà essere pagata per intero più le spese di protesto.

RECLAMI

Trascorsi otto giorni dal ricevimento della merce, non si accettano reclami. I reclami di qualsiasi natura, non sospendono l'obbligo di effettuare i pagamenti secondo la forma convenuta. Nessuna rivalsa per danni o spese di qualsiasi genere sarà riconosciuta.

SOSTITUZIONE

Le eventuali sostituzioni dovranno essere regolate dalle vigenti disposizioni di legge e cioè accompagnate dal relativo d.d.t. che oltre alla motivazione del reso per la sostituzione, dovrà richiamare gli estremi della fattura con la quale è stata precedentemente fornita.

RESTITUZIONI

L'eventuale restituzione di merce dovrà essere preventivamente e formalmente autorizzata ed avvenire in porto franco. Inoltre ogni operazione di reso merce deve essere perfezionata secondo il disposto degli art.1 e 21 del DPR NR 633 del 26.10.72 e successive modifiche.

CARATTERISTICHE DEGLI UTENSILI E CATALOGO

Le caratteristiche degli utensili, le illustrazioni di cui al presente catalogo si intendono approssimative e con riserva di modifiche migliorative senza alcun obbligo di preavviso da parte della INECO SRL. Per ogni e qualsiasi contestazione unico Foro competente è il Tribunale di Lecco.

RIPRODUZIONE

La riproduzione anche parziale del presente catalogo è vietata.

ATTENZIONE

I prezzi validi sono esclusivamente espressi in Euro.

CONDIZIONI GENERALI DI GARANZIA

1. Ineco S.r.L, con sede legale in via Martiri Della Liberazione, 12 23875 Osnago (LC) (di seguito "Ineco"), dichiara e garantisce che i prodotti dalla medesima commercializzati sono stati costruiti nel pieno rispetto delle normative nazionali ed internazionali applicabili, e che gli stessi sono stati collaudati accuratamente e sottoposti a severe ispezioni dal controllo qualità. Per quanto riguarda la data di decorrenza e la durata della garanzia fornita da Ineco si rimanda a quanto stabilito dalla normativa in materia di garanzia del venditore applicabile al momento della vendita dei prodotti da parte di Ineco. In particolare, vengono espressamente confermate le previsioni di legge in materia in base alle quali la garanzia avrà validità di (a) ventiquattro (24) mesi dalla data di consegna del prodotto, risultante dal documento fiscale di acquisto, qualora l'acquirente utilizzi il prodotto per fini estranei alla propria attività imprenditoriale, commerciale e professionale (fermo restando il periodo di due mesi dalla scoperta del difetto ai fini della denuncia dello stesso); ovvero di (b) dodici (12) mesi dalla data di consegna del prodotto, risultante dal documento fiscale di acquisto, qualora l'acquirente acquisti il prodotto per fini inerenti alla propria attività imprenditoriale, commerciale e professionale (ferma restando, ai sensi dell'art. 1495 c.c., la decadenza dal diritto alla garanzia dell'acquirente nel caso di mancata denuncia del difetto entro otto (8) giorni dalla scoperta).

2. Resta comunque inteso che, senza pregiudizio alcuno a quanto previsto dalle previsioni imperative di legge, Ineco non considererà, ai fini della garanzia, vizi / difetti della cosa venduta:

- eventuali danneggiamenti (graffi, ammaccature e simili) della cosa dovuti ad avarie di trasporto;
- danni e malfunzionamenti conseguenti ad un uso improprio e scorretto del prodotto da parte dell'acquirente e che risulti difforme ed in contrasto con le indicazioni d'uso riportate sul libretto d'istruzioni relativo al prodotto acquistato;
- danni e malfunzionamenti del prodotto dovuti e originati da insufficienza o da inadeguatezza dell'impianto elettrico, idrico, o aria compressa di alimentazione di proprietà dell'acquirente, ovvero in caso di alterazioni derivanti da condizioni ambientali, climatiche o d'altra natura;
- danni e malfunzionamenti causati da manomissione, disassemblaggio, o riparazioni effettuate da personale non autorizzato;
- avarie e malfunzionamenti su un prodotto che abbia già subito uno smontaggio totale e/o parziale da personale e/o strutture non autorizzate;
- avarie e malfunzionamenti conseguenti l'errata installazione del prodotto;
- danni e malfunzionamenti derivanti da utilizzo di accessori e pezzi di ricambio non originali;
- normale deperimento ed usura del prodotto. Alla luce di quanto sopra l'ordinaria manutenzione del prodotto, ovvero interventi di periodica taratura e calibrazione degli strumenti di misura, non sono da intendersi quali interventi in Garanzia.

3. Senza pregiudizio alcuno a quanto previsto dalle previsioni imperative di legge, si precisa che l'intervento in garanzia verrà effettuato da centri assistenza autorizzati da Ineco. Il ritiro, la riparazione ovvero l'eventuale sostituzione in garanzia del prodotto avverranno nei limiti di tempo compatibili con le esigenze organizzative di Ineco che, in

ogni caso, s'impegna ad effettuare tali attività nel più breve tempo possibile in modo da limitare il più possibile ogni eventuale pregiudizio all'acquirente. Le riparazioni effettuate in garanzia non daranno comunque luogo a prolungamenti o rinnovi della stessa. Le parti sostituite in garanzia verranno trattenute da Ineco che ne acquisterà altresì la proprietà.

4. Fermo restando quanto previsto dalle applicabili disposizioni di legge, qualora l'acquirente abbia eseguito direttamente, ovvero abbia fatto eseguire da soggetti terzi diversi dai centri assistenza autorizzati Ineco, interventi sul prodotto, ovvero abbia – direttamente o per il tramite di soggetti diversi dai centri assistenza autorizzati Ineco – installato sul prodotto o sostituito pezzi dello stesso con pezzi di ricambio non originali, la presente garanzia non sarà più valida.

5. Qualora l'acquirente riscontri l'esistenza di un possibile difetto del prodotto e/o di un suo componente, il relativo prodotto, in tutte le sue parti, dovrà essere consegnato o spedito dall'acquirente presso un rivenditore o un centro di assistenza autorizzato, unitamente alla ricevuta originale di acquisto del prodotto recante la data di acquisto e la descrizione del prodotto.

6. Qualora l'acquirente utilizzi il prodotto per fini estranei alla propria attività imprenditoriale, commerciale e professionale lo stesso potrà richiedere, a propria scelta, la riparazione ovvero la sostituzione del prodotto senza spesa alcuna in entrambi i casi, sempre che i vizi siano qualificabili come difetti del prodotto ai sensi del Codice del Consumo e che la garanzia sul prodotto venduto sia valida ed efficace. Qualora il rimedio prescelto risulti oggettivamente impossibile o eccessivamente oneroso rispetto all'altro, Ineco valuterà dapprima l'opportunità di riparare il prodotto, se possibile, qualora il costo delle riparazioni non risulti irragionevolmente sproporzionato rispetto (a) al valore ed al prezzo di acquisto del prodotto, (b) all'entità del difetto e (c) alla possibilità che la sostituzione possa essere effettuata senza arrecare notevoli inconvenienti all'acquirente. Qualora il costo delle riparazioni risultasse sproporzionato ai sensi di quanto sopra, Ineco provvederà a sostituire il prodotto. Resta inteso che quanto previsto al presente punto 7 non pregiudica, né può essere interpretato in modo tale da pregiudicare quanto previsto dalle disposizioni di legge applicabili in materia di garanzia e responsabilità del venditore.

7. Qualora al contrario l'acquirente utilizzi il prodotto per fini inerenti alla propria attività imprenditoriale, commerciale e professionale e sempre che la garanzia afferente il prodotto venduto sia valida ed efficace, Ineco, a propria discrezione, potrà scegliere se riparare o sostituire il prodotto, senza spesa alcuna in entrambi i casi. In caso di sostituzione – e salvo il caso in cui ciò non sia possibile – verranno sostituite soltanto le parti del prodotto risultanti difettose. Le parti sostituite diventeranno di proprietà Ineco e non verranno restituite all'acquirente. La durata della garanzia non viene prolungata né la garanzia stessa viene rinnovata per effetto delle riparazioni o delle sostituzioni effettuate da Ineco.

8. Le presenti Condizioni Generali di Garanzia sono regolate dal diritto Italiano. Per qualsiasi controversia dovesse sorgere in merito all'interpretazione, esecuzione o risoluzione delle presenti Condizioni sarà competente il Foro di Milano, ferme restando, ove applicabili, le disposizioni di cui al Codice del Consumo

INECO - Industrial National Cutting Tools S.r.l.

Via Martiri della Liberazione, 12
23875 Osnago, LC

© 2022 - Nessuna parte di questo catalogo può essere riprodotta o trasmessa in qualsiasi forma o con qualsiasi mezzo elettronico, meccanico o altro senza l'autorizzazione scritta da parte di INECO S.r.l.

Finito di stampare nel mese di settembre 2022.

Ideazione grafica
Aglaia S.r.l., Lecco

Stampa
A. G. Bellavite S.r.l., Missaglia